



VOLUME 2
HAZARDOUS MATERIAL ASSESSMENT REPORTS

SURPLUS II HAZARDOUS MATERIAL REMOVAL

Project Number: S201

FORT ORD REUSE AUTHORITY

The Fort Ord Reuse Authority (FORA) performed a Pre- Bid Hazardous Material Assessment of the Surplus II site. This included a Site Soil Background Survey, and Material Surveys of the Buildings.

The three-volume report includes sample and test reports, building maps, location of testing, and other pertinent information related to the safe removal of Hazardous Materials, and is incorporated by reference into the contract.

The Industrial Hygienist Reports can be found at:

<http://www.fora.org/SurplusII.html>

FORA will make one (1) Hard Copy available for reference at the FORA Offices at 920 2nd Avenue, Suite A, Marina, CA 93933. A copy of all 3 volumes and the background soil survey can be purchased for \$200.

FORT ORD REUSE AUTHORITY SURPLUS II BUILDING REMOVAL

CITY OF SEASIDE, MONTEREY COUNTY, CALIFORNIA

SHEET INDEX

- 0.01 TITLE SHEET
- 0.02 NOTES

- 1-1.01 PHASE 1 - EXISTING CONDITIONS & BUILDING REMOVAL
- 1-2.01 PHASE 1 - UTILITY ABANDONMENT/PROTECTION PLAN (GAS, ELECTRIC, TELEPHONE)
- 1-2.02 PHASE 1 - UTILITY ABANDONMENT/PROTECTION PLAN (SANITARY SEWER, WATER, STORM DRAIN)
- 1-3.01 PHASE 1 - EROSION CONTROL PLAN

- 2-1.01 PHASE 2 - EXISTING CONDITIONS & BUILDING REMOVAL
- 2-2.01 PHASE 2 - UTILITY ABANDONMENT/PROTECTION PLAN (GAS, ELECTRIC, TELEPHONE)
- 2-2.02 PHASE 2 - UTILITY ABANDONMENT/PROTECTION PLAN (SANITARY SEWER, WATER, STORM DRAIN)
- 2-3.01 PHASE 2 - EROSION CONTROL PLAN

- 3-1.01 PHASE 3 - EXISTING CONDITIONS & BUILDING REMOVAL
- 3-2.01 PHASE 3 - UTILITY ABANDONMENT/PROTECTION PLAN (GAS, ELECTRIC, TELEPHONE)
- 3-2.02 PHASE 3 - UTILITY ABANDONMENT/PROTECTION PLAN (SANITARY SEWER, WATER, STORM DRAIN)
- 3-3.01 PHASE 3 - EROSION CONTROL PLAN

- 3.02 EROSION CONTROL DETAILS

- 4.01 CONSTRUCTION DETAILS

SHEET LEGEND/DESCRIPTION

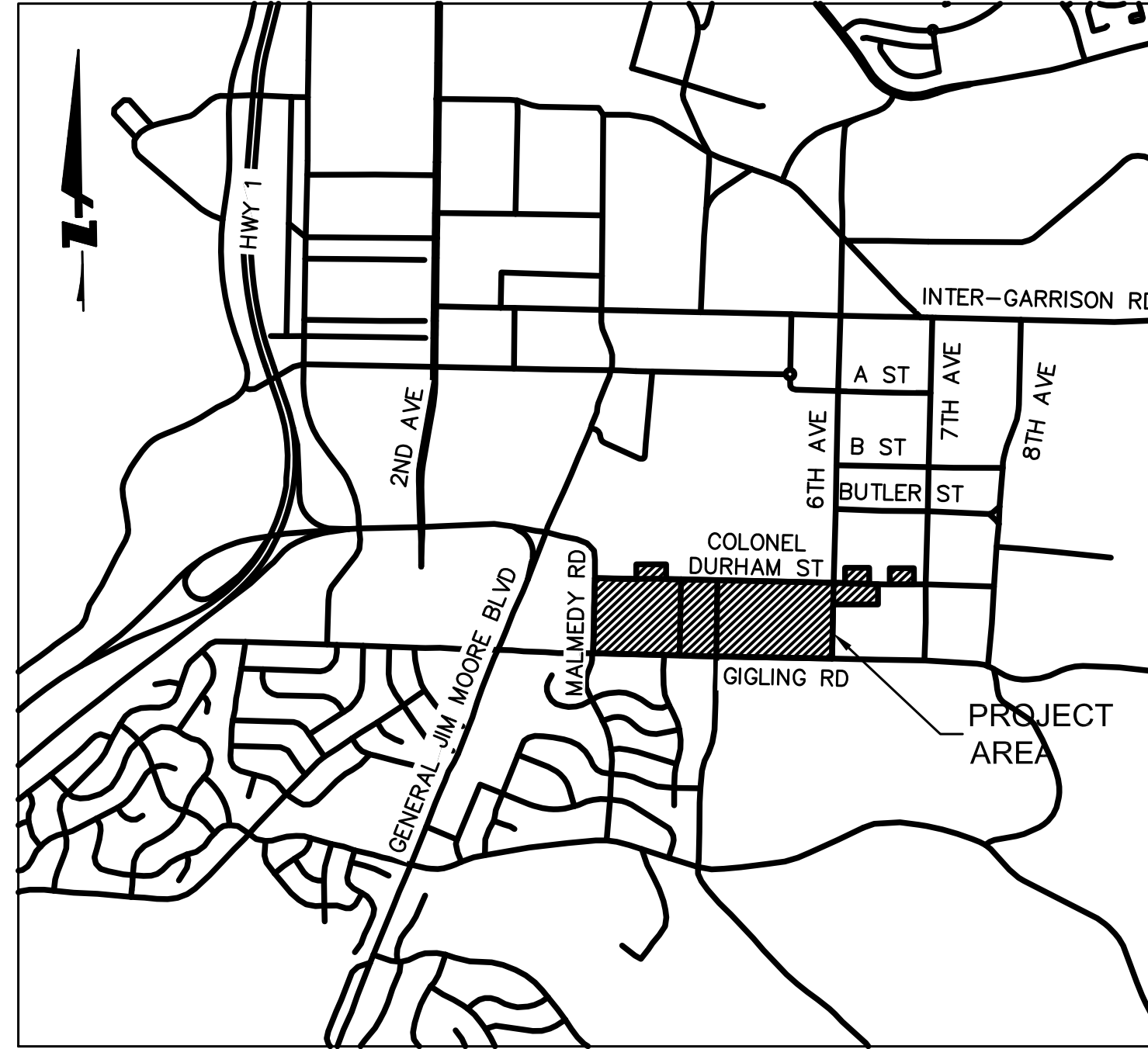
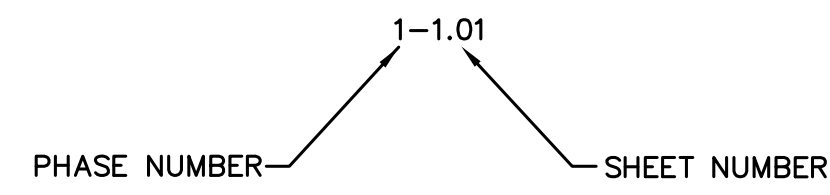

LOCATION MAP
NTS

ABBREVIATIONS

- AC ASPHALT CONCRETE
- AD ADMINISTRATION BUILDING
- AR ARMORY BUILDING
- ACM ASBESTOS CONTAINING MATERIAL
- CF CAFETERIA BUILDING
- CG CURB AND GUTTER
- CO CLEANOUT
- CONC CONCRETE
- CY CUBIC YARD
- E ELECTRICAL
- EX (E) EXISTING
- EMH ELECTRICAL MANHOLE
- FORA FORT ORD REUSE AUTHORITY
- FH FIRE HYDRANT
- G GAS
- GR GRATE ELEVATION
- HB HOSE BIBB
- INV INVERT ELEVATION
- JP JOINT POLE
- JT JOINT TRENCH
- LF LINEAR FEET
- MBUAPCD MONTEREY BAY UNIFIED AIR POLLUTION CONTROL DISTRICT
- MIN MINIMUM
- OH OVERHEAD
- RIM RIM ELEVATION
- RP ROLLING PIN BUILDING
- SD STORM DRAIN
- SDCB STORM DRAIN CATCH BASIN
- SDMH STORM DRAIN MANHOLE
- SS SANITARY SEWER
- SSMH SANITARY SEWER MANHOLE
- TEL TELEPHONE
- TPZ TREE PROTECTION ZONE
- TYP TYPICAL
- W WATER
- WV WATER VALVE

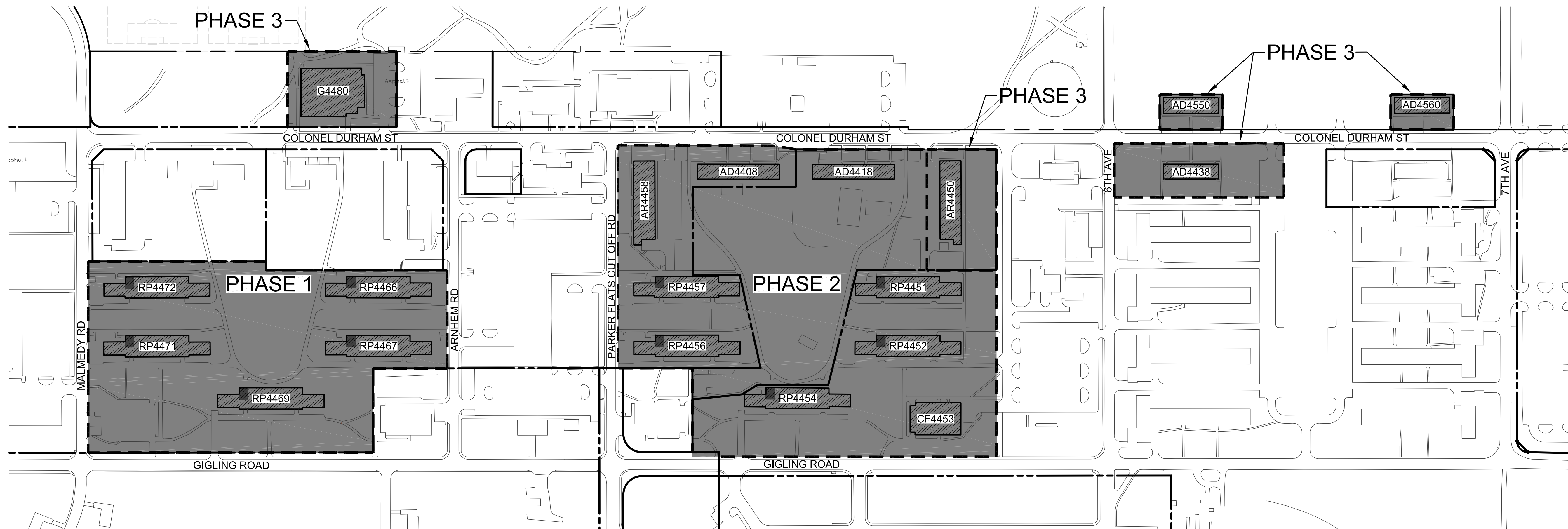

SITE PLAN
NTS

HARRIS & ASSOCIATES
 450 Lincoln Avenue, Suite 103
 Salinas, CA 93901
 (831) 233-9242

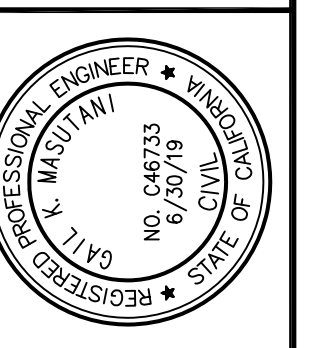
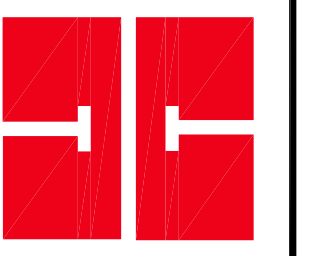

SURPLUS II - BUILDING REMOVAL
 TITLE SHEET
 CITY OF SEASIDE MONTEREY COUNTY CALIFORNIA

No.	Date	Scale	Design	Drawn	Approved	Job No.

NOT FOR CONSTRUCTION FOR BID PURPOSES ONLY S201-1TB1, 12-8-17
 Drawing Number:
0.01

Plotted - 12/11/2017 9:23:19 AM :: Saved - 12/11/2017 9:22:05 AM :: I:\Projects\Fort Ord Reuse Authority\Surplus II Bid Demolitions\11-References-Misc\Surplus II 92% Dwg-Specs-Front_End\Drawings\00_FGSP\Title.dwg :: Crown

I. GENERAL NOTES

- ALL WORK SHALL BE PERFORMED IN ACCORDANCE WITH THE PROJECT SPECIFICATIONS AND THESE PLANS.
- THE CONTRACTOR SHALL GIVE INSPECTORS, THREE (3) WORKING DAYS ADVANCE NOTICE FOR INSPECTION SERVICES.
- ALL REVISIONS TO THESE PLANS MUST BE REVIEWED AND APPROVED IN WRITING BY THE DESIGN ENGINEER PRIOR TO CONSTRUCTION OF AFFECTED ITEMS, REVISIONS SHALL BE ACCURATELY SHOWN ON REVISED PLANS.
- THE CONTRACTOR SHALL RESTORE ANY PERIMETER CURB(S) AND SIDEWALKS WHICH ARE DAMAGED DUE TO THE CONTRACTOR'S WORK TO THEIR PREVIOUS CONDITION.
- IF TEMPORARY LANE CLOSURES ARE REQUIRED FOR CONSTRUCTION OPERATIONS, THE CONTRACTOR SHALL PREPARE A TRAFFIC CONTROL PLAN, OBTAIN APPROVAL AND NECESSARY PERMITS FROM FORA BEFORE COMMENCING WORK. THE CONTRACTOR SHALL ALSO PROVIDE FLAGMEN, CONES OR BARRICADES, AS NECESSARY TO CONTROL TRAFFIC AND PREVENT HAZARDOUS CONDITIONS PER CALTRANS STANDARDS.
- EXISTING ROADWAYS SHALL BE MAINTAINED DURING CONSTRUCTION TO THE SATISFACTION OF FORA.
- EXCAVATIONS SHALL BE ADEQUATELY SHORED, BRACED AND SHEATHED SO THAT THE EARTH WILL NOT SLIDE OR SETTLE AND SO THAT EXISTING IMPROVEMENTS WILL BE FULLY PROTECTED FROM DAMAGE. ANY DAMAGE RESULTING FROM A LACK OF ADEQUATE SHORING, BRACING AND SHEATHING, SHALL BE THE RESPONSIBILITY OF THE CONTRACTOR AND HE SHALL COMPLETE NECESSARY REPAIRS OR RECONSTRUCTION AT HIS OWN EXPENSE. WHERE THE EXCAVATION FOR A CONDUIT TRENCH, AND/OR STRUCTURE IS FIVE (5) FEET OR MORE IN DEPTH, THE CONTRACTOR SHALL PROVIDE SHEATHING, SHORING AND BRACING IN CONFORMANCE WITH THE APPLICABLE CONSTRUCTION SAFETY ORDERS OF THE DIVISION OF INDUSTRIAL SAFETY OF THE STATE OF CALIFORNIA. THE CONTRACTOR SHALL COMPLY WITH OSHA REQUIREMENTS AT ALL TIMES.
- THE CONTRACTOR SHALL PROVIDE DUST CONTROL FOR THE ENTIRE PROJECT SITE AT ALL TIMES. THE SITE SHALL BE SPRINKLED AS NECESSARY TO PREVENT DUST NUISANCE. IN THE EVENT THE CONTRACTOR NEGLECTS TO USE ADEQUATE MEASURES TO CONTROL DUST, FORA RESERVES THE RIGHT TO TAKE WHATEVER MEASURES ARE NECESSARY TO CONTROL DUST AND CHARGE THE COST TO THE CONTRACTOR.
- DURING CONSTRUCTION, STREETS SHALL BE CLEANED AS OFTEN AS REQUIRED TO REMOVE ANY ACCUMULATION OF MUD AND DEBRIS RESULTING FROM THIS CONSTRUCTION. IF IMPORT OR EXPORT OF DIRT IS NECESSARY, THE CONTRACTOR SHALL OBTAIN APPROVAL FOR THE HAULING ROUTE(S) FROM CITY OF SEASIDE. HAULING ROUTE(S) SHALL NOT GO THROUGH CSUMB CAMPUS. CONTRACTOR TO COORDINATE WITH THE CITY OF SEASIDE. THE HAULING ROUTES SHALL BE STRICTLY ADHERED TO BY THE CONTRACTOR AND ALL SUBCONTRACTORS. DIRT HAULING PERMIT REQUIRED.
- ALL CONSTRUCTION STAKING SHALL BE THE CONTRACTOR'S RESPONSIBILITY. FORA WILL PROVIDE PRIMARY SURVEY STAKING CONSISTING OF SITE CORNERS WITH 2"x2" WOOD HUBS OR PIPES OFFSET 10" OUTSIDE SITE OR MARKING ON SIDEWALK OR TOP OF CURB. CONTRACTOR TO USE THESE HUBS AS REFERENCE FOR THEIR CONSTRUCTION STAKING.
- SHOULD IT APPEAR THAT THE WORK TO BE DONE OR ANY MATTER RELATIVE THERETO IS NOT SUFFICIENTLY DETAILED OR SPECIFIED IN THE CONSTRUCTION DOCUMENTS, THE CONTRACTOR SHALL NOTIFY FORA'S PROJECT MANAGER, BEFORE PROCEEDING WITH THE WORK IN QUESTION.
- WHEN SPECIFICATIONS OR STANDARDS FROM DIFFERENT AUTHORITIES DIFFER FOR THE SAME SUBJECT MATTER, THE MORE STRINGENT SHALL GOVERN. IF THERE ARE ITEMS THAT CONTRADICT EACH OTHER IN THE BID DOCUMENTS AND THE CONTRACTOR DID NOT CLARIFY PRIOR TO THE BID, THEN THE STRICTER AND/OR BETTER QUALITY, SHALL APPLY.
- UPON SATISFACTORY COMPLETION OF THE WORK, THE ENTIRE WORK SITE SHALL BE CLEANED UP AND LEFT WITH A SMOOTH AND NEATLY GRADED SURFACE FREE OF CONSTRUCTION WASTE AND RUBBISH OF ANY NATURE OR ANYTHING LARGER THAN 3 INCHES BY THE CONTRACTOR. EXCLUDES LANDSCAPING & TREES NOT DESIGNATED FOR REMOVAL.
- CONTRACTOR SHALL COORDINATE WORK WITH MONTEREY BAY UNIFIED AIR POLLUTION CONTROL DISTRICT (MBUAPCD) PRIOR TO START. ALL WORK SHALL BE DONE IN COMPLIANCE WITH MBUAPCD.
- CONSTRUCTION HOURS SHALL BE COORDINATED WITH FORA PRIOR TO THE START OF CONSTRUCTION. DEVIATIONS FROM THIS SCHEDULE WILL REQUIRE APPROVAL IN ADVANCE BY FORA.
- THE CONTRACTOR SHALL ERECT A TEMPORARY CONSTRUCTION FENCE ALONG THE PROJECT SITE TO SECURE THE SITE AS REQUIRED.
- IN ORDER TO MINIMIZE CONSTRUCTION NOISE IMPACTS, ALL ENGINE DRIVEN CONSTRUCTION VEHICLES, EQUIPMENT AND PNEUMATIC TOOLS SHALL BE REQUIRED TO USE EFFECTIVE INTAKE AND EXHAUST MUFFLERS; EQUIPMENT SHALL BE PROPERLY ADJUSTED AND MAINTAINED; ALL CONSTRUCTION EQUIPMENT SHALL BE EQUIPPED WITH MUFFLERS IN ACCORDANCE WITH OSHA STANDARDS CONSISTENT WITH MITIGATION MEASURE NOI-GDP-1 AND NOI-SDP-1 IDENTIFIED IN THE MITIGATION MONITORING PROGRAM. CONTRACTOR SHALL COMPLY WITH CITY OF SEASIDE NOISE ORDINANCE REQUIREMENTS AT ALL TIMES. ADDITIONALLY, CONTRACTORS SHOULD ACCOUNT FOR 6-WEEKS OF "QUIET TIME" (3-WEEKS PER SEMESTER) DURING FINALS AT THE NEIGHBORING UNIVERSITY DURING WHICH THEY COULD PERFORM "OTHER" ACTIVITIES SUCH AS HAULING AND LOADING.
- THE CONTRACTOR SHALL NOTIFY FORA'S PROJECT MANAGER, IN WRITING, AT LEAST 48 HOURS PRIOR TO COMMENCING WORK OF ALL DIFFERENCES BETWEEN THE FIELD CONDITIONS AND THE DESIGN INDICATED ON THE PLANS. COMMENCEMENT OF THE RELATED WORK SHALL BE SUBJECT TO THE WRITTEN APPROVAL OF FORA BEFORE ALTERED WORK IS STARTED VIA REQUEST FOR INFORMATION OR CHANGE. UNAUTHORIZED WORK WILL BE AT THE CONTRACTOR'S RISK & EXPENSE AND MAY BE REQUIRED TO BE REPAIRED OR REPLACED IF NOT AUTHORIZED BY FORA, AT CONTRACTOR'S EXPENSE.
- THE GENERAL CONTRACTOR SHALL PROVIDE A QUALIFIED SUPERVISOR ON THE JOB SITE AT ALL TIMES DURING CONSTRUCTION.
- ALL WORK SHALL CONFORM TO THE APPLICABLE CITY/DISTRICT CODES. SUPERINTENDENCE OF CONSTRUCTION SHALL BE DILIGENTLY PERFORMED BY PERSON(S) AUTHORIZED TO DO SO AT ALL TIMES DURING WORKING HOURS. THE STORING OF GOODS, EQUIPMENT AND/OR MATERIALS ON THE PUBLIC SIDEWALK AND/OR A PUBLIC STREET SHALL NOT BE ALLOWED UNLESS A SPECIAL PERMIT IS ISSUED BY FORA OR FORA'S REPRESENTATIVE.
- THE CONTRACTOR SHALL OBTAIN ANY PERMITS REQUIRED BY THE CITY OF SEASIDE OR WITH OTHER AGENCIES.
- CONTRACTOR TO CONFIRM THAT FORA HAS RECEIVED PERMISSION FROM CSUMB PRIOR TO ACCESSING THEIR PROPERTY FOR WORK IN THE AREA BY BUILDINGS AD4550 AND AD4560.

II. EXISTING CONDITIONS

- EXISTING TOPOGRAPHIC INFORMATION SHOWN ON THESE PLANS IS BASED ON RECORD DOCUMENTS AND AERIAL PHOTOGRAPHY.

CONTRACTOR SHALL REVIEW THE PLANS AND SPECIFICATIONS AND CONDUCT FIELD INVESTIGATIONS AS REQUIRED TO VERIFY EXISTING CONDITIONS AT THE PROJECT SITE.
- INFORMATION REGARDING EXISTING SUBSURFACE IMPROVEMENTS AND UTILITIES SHOWN ON THESE PLANS WAS TAKEN FROM RECORD DATA KNOWN TO THE DESIGN ENGINEER AND IS NOT MEANT TO BE A FULL CATALOG OF EXISTING CONDITIONS. CONTRACTOR SHALL CONDUCT FIELD INVESTIGATIONS AS REQUIRED TO VERIFY THE LOCATION AND ELEVATION OF ALL EXISTING SUBSURFACE IMPROVEMENTS AND UTILITIES (WHETHER SHOWN ON THESE PLANS OR NOT) PRIOR TO THE COMMENCEMENT OF WORK. CONTRACTOR SHALL NOTIFY THE DESIGN ENGINEER IMMEDIATELY UPON DISCOVERY OF ANY DISCREPANCIES BETWEEN EXISTING CONDITIONS IN THE FIELD AND INFORMATION SHOWN ON THESE PLANS.
- ELEVATIONS AND LOCATIONS OF ALL EXISTING UTILITIES SHALL BE VERIFIED BY THE CONTRACTOR PRIOR TO START OF ANY CONSTRUCTION AFFECTING SAID LINES.
- CONTRACTOR SHALL CONTACT UNDERGROUND SERVICE ALERT (USA) AT (800) 642-2444 AT LEAST TWO (2) WORKING DAYS PRIOR TO COMMENCEMENT OF ANY EXCAVATION OR GRADING WORK.
- IF THE CONTRACTOR FAILS TO INVESTIGATE KNOWN OR UNKNOWN EXISTING SUBSURFACE IMPROVEMENTS PRIOR TO ANY CONSTRUCTION ACTIVITIES AND UNFORESEEN CONDITIONS ARISE, ALL COSTS AND SCHEDULE IMPACTS WILL BE BORNE BY THE CONTRACTOR.

III. UTILITIES

- CONTRACTOR SHALL MAKE ARRANGEMENTS AT LEAST THREE (3) WORKING DAYS IN ADVANCE WITH APPROPRIATE UTILITY COMPANIES PRIOR TO ANY DISCONNECTION, ABANDONMENT OF, OR WORK WITH THE LINES AND APPURTENANT STRUCTURES OF THE UTILITIES LISTED BELOW:

STORM DRAIN - CITY OF SEASIDE
SANITARY SEWER - MCWD
WATER - MCWD
ELECTRICAL - PG&E
TELEPHONE - AT&T
GAS - PG&E
- BEFORE DISCONNECTING UTILITY SERVICE TO ANY ESTABLISHMENT, CONTRACTOR SHALL GIVE A MINIMUM SEVEN (7) DAYS OF ADVANCE NOTICE TO ESTABLISHMENT IN WRITING BEFORE THEIR UTILITY IS SHUT DOWN. MAKE ARRANGEMENTS WITH THOSE ESTABLISHMENTS FOR A SCHEDULED SHUT DOWN AND COORDINATE DATE OF SHUT DOWN, DURATION, INCONVENIENCE, DELAYS, ETC. WITH A REPRESENTATIVE OF FORA.
- BEFORE ABANDONING OR REMOVING ANY UTILITIES, CONTRACTOR IS REQUIRED TO OBTAIN ANY AND ALL NECESSARY PERMITS.

IV. ABANDONMENT OF EX UTILITY PIPES AND/OR CONDUITS

- EXISTING GRADE MENTIONED IN THESE PLANS IS THE SUBGRADE UNDERNEATH BUILDING FOOTINGS OR AGGREGATE BASE IN ASPHALT PAVEMENT.
- EXISTING UTILITY PIPES AND/OR CONDUIT TO BE CAPPED AND ABANDONED IN PLACE UNLESS OTHERWISE NOTED.

V. SEDIMENTATION AND POLLUTION CONTROL

- CONTRACTOR SHALL FOLLOW ALL REQUIREMENTS OF THE PROJECT STORM WATER POLLUTION PREVENTION PLAN (SWPPP), WHICH WILL BE PROVIDED BY DESIGNER, DOCUMENT #20175005-10.
- CONTRACTOR SHALL UPDATE THE SWPPP AS NECESSARY. A COPY OF THE SWPPP SHALL REMAIN ON-SITE THROUGHOUT CONSTRUCTION.
- CONTRACTOR SHALL IMPLEMENT ALL SEDIMENTATION AND POLLUTION CONTROL MEASURES SHOWN ON THE EROSION CONTROL PLANS AND DETAILS INCLUDED IN THESE IMPROVEMENT PLANS.
- ALL FINES IMPOSED AND REPAIRS REQUIRED FOR NOT FOLLOWING THE SWPPP WILL BE PAID BY THIS CONTRACTOR.

VI. RECORD DRAWINGS

- DISPOSITION OF ALL UTILITIES ON SITE. THE RECORD DRAWING SHALL BE "REDLINED" ON A SET OF CONSTRUCTION PRINTS AND INDICATE THE FOLLOWING:
 - IDENTIFY LOCATION, SIZE, MATERIAL AND TYPE OF UTILITY (INCLUDING UNDERGROUND STORAGE TANKS) THAT WAS ABANDONED OR LEFT IN PLACE AND THE CONDITION THEREOF.
 - NOTE THE LOCATION AND ELEVATION (OR APPROXIMATE DEPTH RELATIVE TO FINISH GRADE) OF ANY EXISTING UTILITIES LEFT IN PLACE. CONTRACTOR SHALL DELIVER REDLINED PRINTS TO THE DESIGN ENGINEER WITH A COPY TO FORA.
- THE DESIGN ENGINEER INCORPORATES CONTRACTOR'S INFORMATION INTO RECORD DRAWINGS AND SUBMITS THEM TO FORA.

VII. STATEMENT OF RESPONSIBILITY

- CONSTRUCTION CONTRACTOR AGREES THAT IN ACCORDANCE WITH GENERALLY ACCEPTED CONSTRUCTION PRACTICES, CONSTRUCTION CONTRACTOR WILL BE REQUIRED TO ASSUME SOLE AND COMPLETE RESPONSIBILITY FOR JOB SITE CONDITIONS DURING THE COURSE OF CONSTRUCTION OF THE PROJECT, INCLUDING SAFETY OF ALL PERSONS AND PROPERTY. THIS REQUIREMENT SHALL BE MADE TO APPLY CONTINUOUSLY AND NOT BE LIMITED TO NORMAL WORKING HOURS, AND CONSTRUCTION CONTRACTOR FURTHER AGREES TO DEFEND, INDEMNIFY FORA & ITS REPRESENTATIVES AND HOLD DESIGN PROFESSIONAL HARMLESS FROM ANY AND ALL LIABILITY, REAL OR ALLEGED, IN CONNECTION WITH THE PERFORMANCE OF WORK ON THIS PROJECT, EXCEPTING LIABILITY ARISING FROM THE SOLE NEGLIGENCE OF THE DESIGN PROFESSIONAL.
- CONTRACTOR SHALL COMPLY WITH ALL STATE, COUNTY AND CITY LAWS AND ORDINANCES; AND REGULATIONS OF THE DEPARTMENT OF INDUSTRIAL RELATIONS, O.S.H.A. AND INDUSTRIAL ACCIDENT COMMISSION RELATING TO SAFETY AND CHARACTER OF WORK EQUIPMENT AND LABOR PERSONNEL.

VIII. UNAUTHORIZED CHANGES AND USES

- THE DESIGN ENGINEER PREPARING THESE PLANS WILL NOT BE RESPONSIBLE FOR, OR LIABLE FOR, UNAUTHORIZED CHANGES TO OR USES OF THESE PLANS. ALL CHANGES TO THE PLANS MUST BE IN WRITING AND MUST BE APPROVED BY THE PREPARER OF THESE PLANS.

DEMOLITION NOTES

- TREE LOCATIONS ARE APPROXIMATE. CONTRACTOR TO FIELD VERIFY LOCATION OF AND REMOVE TREES AND STUMPS WITHIN 25-FT OF BUILDINGS DESIGNATED FOR REMOVAL. ALL OTHER TREES TO REMAIN UNLESS OTHERWISE NOTED. REFER TO "FORT ORD SURPLUS BUILDING REMOVAL TREE SURVEY" BY FRANK ONO, CERTIFIED ARBORIST #536, FOR ADDITIONAL INFORMATION.
- CONTRACTOR TO CUT UTILITIES SERVING BUILDINGS TO BE REMOVED AT A DISTANCE OF 10-FT FROM BUILDING FOOTPRINT. CONTRACTOR TO REMOVE SEGMENTS OF UTILITY LINES BETWEEN UTILITY CUT AND BUILDING FOOTPRINT, REMAINING PORTION OF CUT UTILITIES TO BE CAPPED AND ABANDONED IN PLACE UNLESS NOTED OTHERWISE. SEE NOTE 4.
- CONTRACTOR TO COORDINATE WITH RESPECTIVE UTILITY COMPANIES AND VERIFY UTILITIES ARE INACTIVE AND/OR DISCONNECTED PRIOR TO WORK ON UTILITIES AND BUILDING REMOVAL.
- ALL PERIMETER CURB, GUTTER AND SIDEWALK TO BE PROTECTED. CONTRACTOR TO REPLACE IN-KIND ANY PERIMETER CURB, GUTTER AND SIDEWALK THAT IS DAMAGED DURING BUILDING REMOVAL AND UTILITY ABANDONMENT/REMOVAL.
- CONTRACTOR TO REMOVE SLAB AT THE BOTTOM OF BUILDINGS. BASEMENTS AND CRAWL SPACES ARE SHOWN FOR INFORMATIONAL PURPOSES ONLY. CONTRACTOR IS RESPONSIBLE TO VERIFY BASEMENT AND CRAWL SPACE INFORMATION FOR BIDDING AT THEIR EXPENSE.
 - ALL ROLLING PIN BUILDINGS HAVE BASEMENTS & CRAWL SPACE.
 - THE ADMINISTRATIVE, ARMORY, AND GYM BUILDINGS HAVE NO BASEMENTS.
 - THE CAFETERIA HAS A CRAWL SPACE UNDER THE KITCHEN PORTION OF THE BUILDING.
- EXISTING CONTOURS AND ELEVATIONS SHOWN FOR REFERENCE ONLY WERE BASED ON GIS INFORMATION PROVIDED BY FORA AND AERIAL PHOTOGRAPHY, REFERENCED TO NAVD88 WITH A ±2-FT LEVEL OF ACCURACY.
- IF CONTRACTOR LOCATES AN UNDERGROUND STORAGE TANK (UST) DURING COURSE OF WORK, WORK MUST STOP IN THE AREA AND FORA AND THE CONSTRUCTION MANAGER ARE TO BE NOTIFIED IMMEDIATELY SO THAT FORA CAN COORDINATE REMOVAL WITH THE US ARMY. WORK IN THIS AREA MAY RECOMMENCE WITH FORA APPROVAL.
- CONTRACTOR TO FIELD VERIFY LOCATION OF GAS AND ELECTRIC LINES SERVING BUILDINGS TO BE REMOVED, AND COORDINATE DISCONNECTION POINTS AND CONDUIT ABANDONMENT WITH PG&E. SEE NOTE 4.
- CONTRACTOR TO FIELD VERIFY LOCATION OF TELECOM LINES SERVING BUILDINGS TO BE REMOVED, AND COORDINATE DISCONNECTION POINTS AND CONDUIT ABANDONMENT WITH AT&T, COMCAST AND ANY OTHER AFFECTED COMMUNICATIONS COMPANY. SEE NOTE 4.
- CONTRACTOR TO VERIFY THAT FORA AND MCWD HAVE COORDINATED AND FINALIZED ON SEWER AND WATER DISCONNECTION METHOD(S) PRIOR TO STARTING WORK ON SEWER AND WATER FACILITIES.
- CONTRACTOR SHALL GRADE HOLES LEFT BY BUILDING REMOVAL, INCLUDING WHERE THERE ARE BASEMENTS AND CRAWL SPACES. MAXIMUM SLOPE SHALL BE 3:1.
- FORA WILL PROVIDE PRIMARY SURVEY STAKING OF SITE CORNERS WITH WOOD HUBS OR PIPES, AND MARKINGS ON SIDEWALKS OR TOP OF CURB.
- CONTRACTOR TO REMOVE OIL/WATER SEPARATOR SERVING CAFETERIA BUILDING CF4453 AND PROPERLY DISPOSE OF ANY REMAINING OILS AND/OR SUSPENDED SOLIDS.

LEGEND

	LIMIT OF WORK. SEE DEMOLITION NOTE 5
	PROPERTY LINE
	BUILDING TO BE REMOVED SEE DEMOLITION NOTE 6 & 12
	APPROXIMATE BASEMENT LOCATION SEE DEMOLITION NOTE 6 & 12
	CAP/DISCONNECTION POINT
	EXISTING TREE AND ID NUMBER SEE DEMOLITION NOTES 1 & 2
	EXISTING TREE TO BE REMOVED
	EXISTING STORM DRAIN LINE
	EXISTING SANITARY SEWER LINE
	EXISTING ELECTRICAL LINE
	EXISTING GAS LINE
	EXISTING DOMESTIC WATER LINE
	EXISTING TELECOM LINE
	EXISTING OVERHEAD LINE
	EXISTING STORM DRAIN INLET
	EXISTING STORM DRAIN MANHOLE
	EXISTING SEWER MANHOLE
	EXISTING JOINT POLE
	EXISTING ELECTRICAL STRUCTURE
	EXISTING STREET LIGHT
	EXISTING FIRE HYDRANT
	SURVEY STAKING LOCATION, SEE DEMOLITION NOTE 13

Plotted - 12/11/2017 9:22:45 AM :: Saved - 12/11/2017 9:22:05 AM :: I:\Projects\Surplus II - Building Removal\References\Misc\Surplus II 92% Dwg-Specs-Front_End\Drawings\001_F09P15.dwg :: Chiron

HARRIS & ASSOCIATES
450 Lincoln Avenue, Suite 103
Sausalito, CA 94965
(831) 233-9242

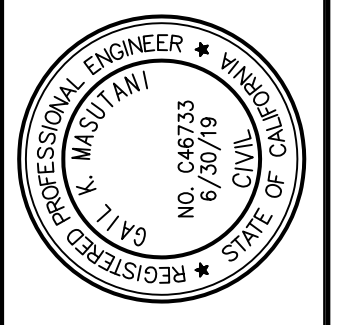
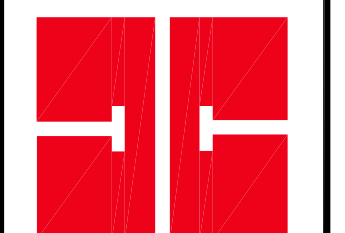

SURPLUS II - BUILDING REMOVAL

NOTES

CITY OF SEASIDE MONTEREY COUNTY CALIFORNIA

NOT FOR CONSTRUCTION FOR BID PURPOSES ONLY S201-1TB1, 12-8-17

Date:	No.:	Revisions:
Scale:		
Design:		
Drawn:		
Approved:		
Job No.:		
Drawing Number:		
0.02		

NOTE

REFER TO SHEET 1.01 FOR EXISTING CONDITIONS AND BUILDING REMOVAL, AND SHEETS 2.01 AND 2.02 FOR UTILITY ABANDONMENT/PROTECTION.

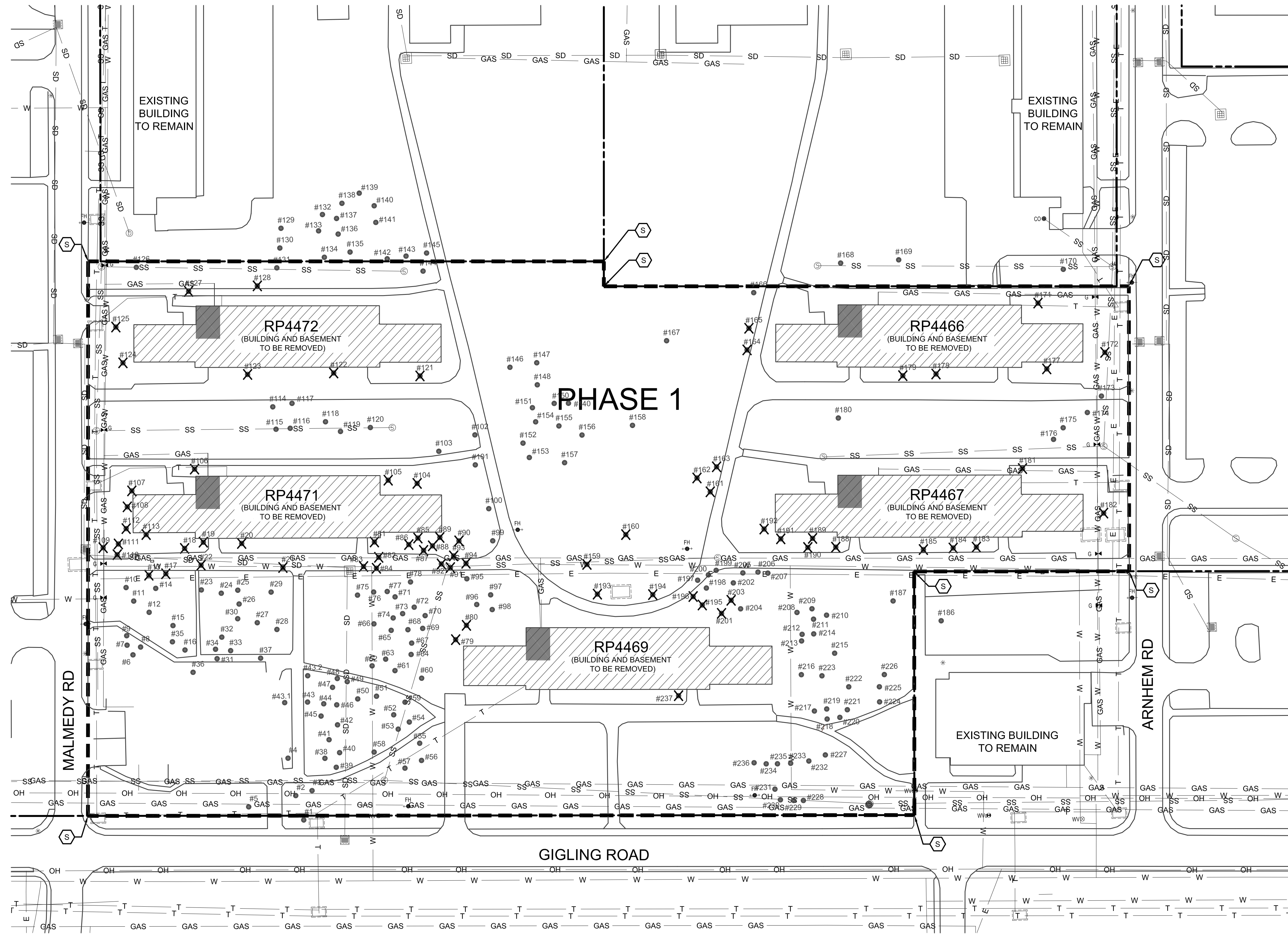

Plotted - 12/11/2017 2:17:24 PM :: Saved - 12/11/2017 9:16:03 AM :: I:\Projects\Fort Ord Reuse Authority\Surplus II Bldg Demolitions\11-References-Misc\Surplus II 95% Dwg-Specs-Front_End\Drawings\101_FOSPDE.dwg :: Chron

HARRIS & ASSOCIATES
 450 Lincoln Avenue, Suite 103
 Salinas, CA 93901
 (831) 233-9242

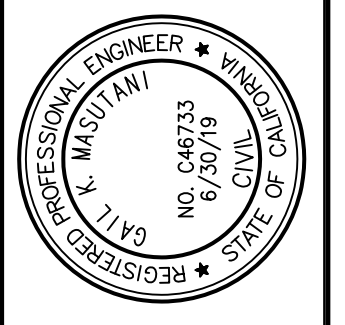
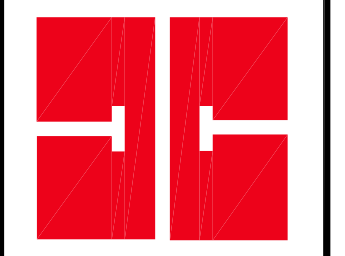

SURPLUS II - BUILDING REMOVAL
 PHASE 1 - EXISTING CONDITIONS &
 BUILDING REMOVAL
 CITY OF SEASIDE MONTEREY COUNTY CALIFORNIA

Date:	No.	Revisions
Scale:		
Design:		
Drawn:		
Approved:		
Job No.:		
Drawing Number:	1-1.01	

NOT FOR CONSTRUCTION FOR BID PURPOSES ONLY S201-1TB1, 12-8-17

Plotted - 12/11/2017 9:55:01 AM :: Saved - 12/6/2017 1:42:06 PM :: I:\Projects\Fort Ord Reuse Authority\Surplus II Bldg Demolitions\11-References-Misc\Surplus II 95% Dwg-Specs-Front_End\Drawings\201_FOSPDE.dwg :: Brown

KEYNOTES (SEE NOTE 12 & 13)

REMOVE:

- 102 CAP AND REMOVE EXISTING GAS LATERAL AND STRUCTURES.
- 104 CAP AND REMOVE EXISTING ELECTRICAL CONDUIT LATERAL AND STRUCTURES.
- 106 CAP AND REMOVE EXISTING TELECOM LATERAL AND STRUCTURES.

PROTECT:

- 201 CAUTION! PROTECT EXISTING OVERHEAD LINES & JOINT POLES
- 203 PROTECT EXISTING GAS LINE AND VALVES
- 204 PROTECT EXISTING ELECTRICAL LINE AND STRUCTURES
- 207 PROTECT EXISTING STREET LIGHT, CONDUIT, AND BOX
- 209 PROTECT EXISTING BUILDING
- 210 PROTECT EXISTING TELECOM LINE AND STRUCTURES

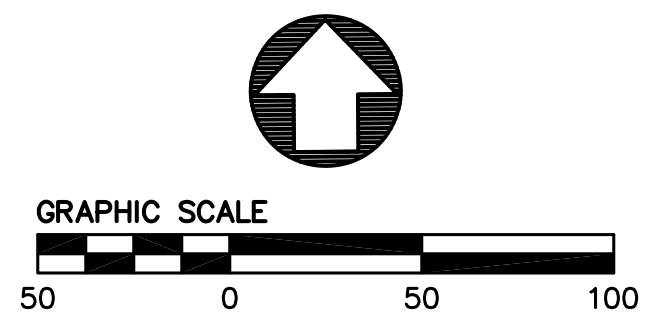
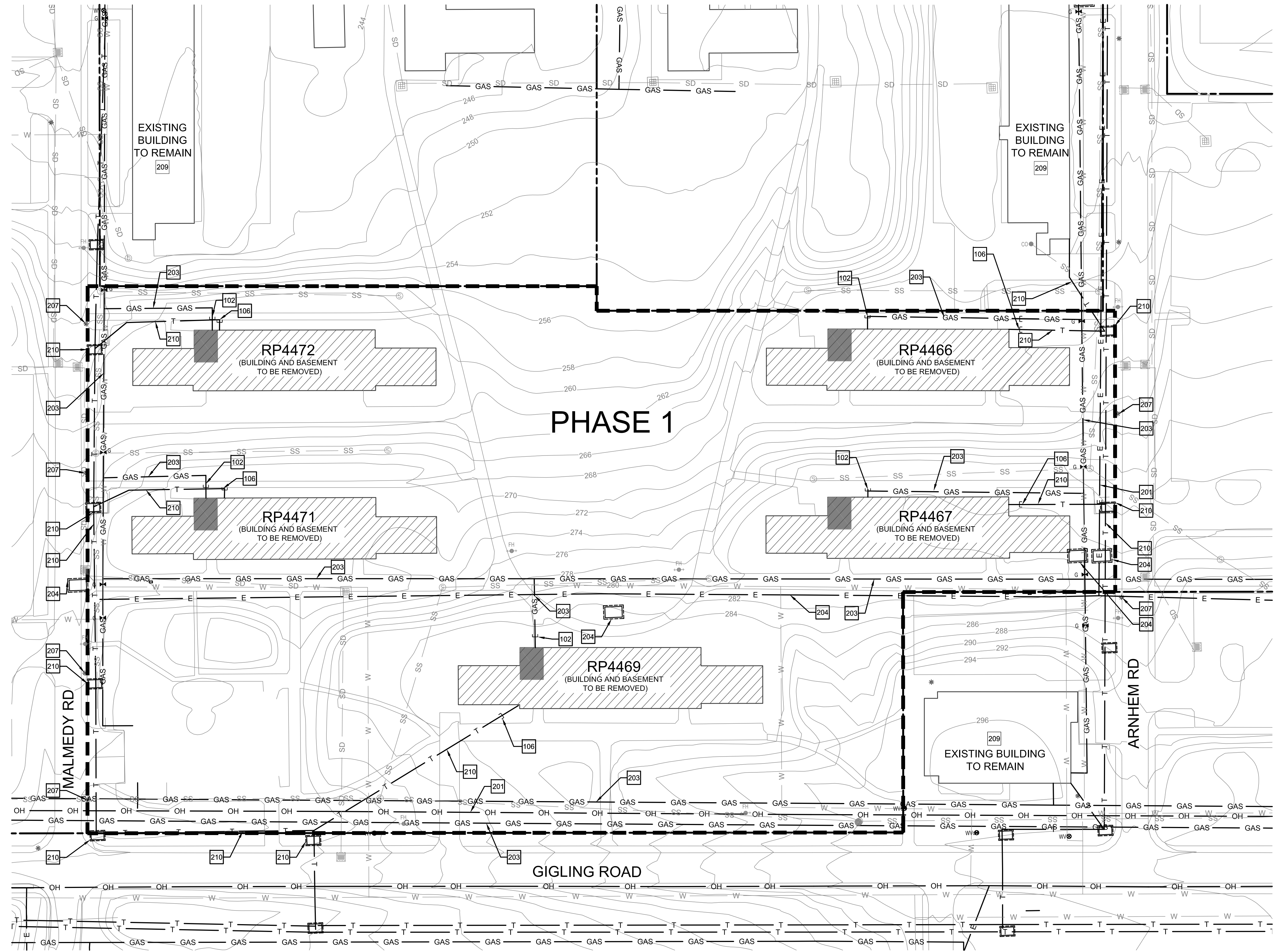

HARRIS & ASSOCIATES
 450 Lincoln Avenue, Suite 103
 Salinas, CA 93901
 (831) 233-9242

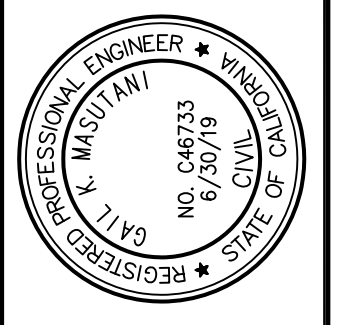
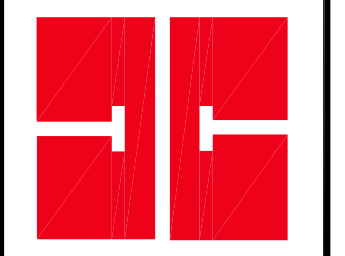

SURPLUS II - BUILDING REMOVAL
 PHASE 1 - UTILITY ABANDONMENT/PROTECTION
 PLAN (GAS, ELECTRIC, TELEPHONE)
 CITY OF SEASIDE MONTEREY COUNTY CALIFORNIA

Date:	No.:
Scale:	Revisions:
Design:	
Drawn:	
Approved:	
Job No.:	
Drawing Number:	
1-2.01	

NOT FOR CONSTRUCTION FOR BID PURPOSES ONLY S201-1TB1, 12-8-17

NOTE

REFER TO SHEET 1.01 FOR EXISTING CONDITIONS AND BUILDING REMOVAL, AND SHEETS 2.01 AND 2.02 FOR UTILITY ABANDONMENT/PROTECTION.

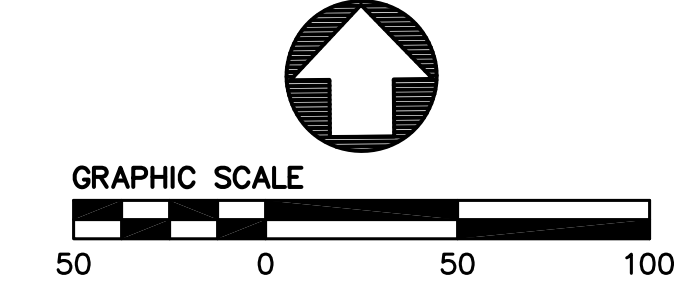
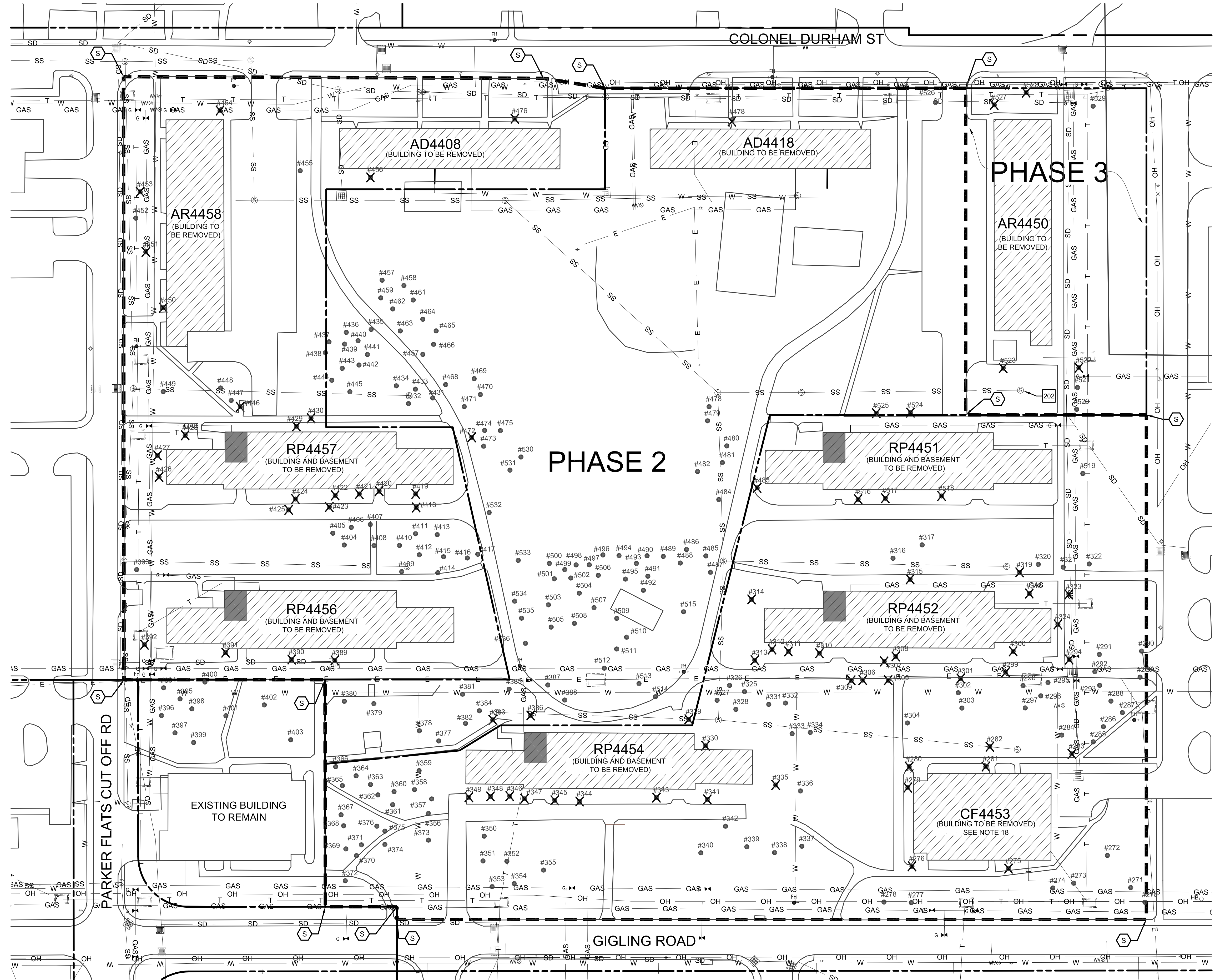

Plotted - 12/17/2017 9:15:07 AM :: Saved - 12/6/2017 3:37:37 PM :: I:\Projects\Fort Ord Reuse Authority\Surplus II Bldg Demolitions\11-References-Misc\Surplus II 95% Dwg-Specs-Front-End\Drawings\101_FOSPDE.dwg :: Crown

HARRIS & ASSOCIATES
450 Lincoln Avenue, Suite 103
Salinas, CA 95901
(831) 233-9242

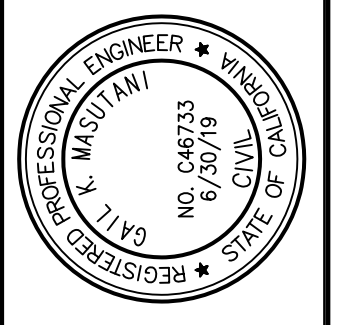
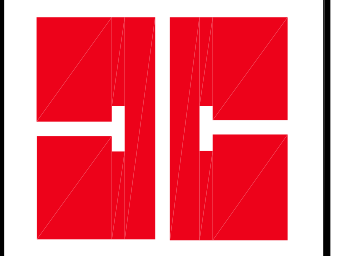

SURPLUS II - BUILDING REMOVAL
PHASE 2 - EXISTING CONDITIONS &
BUILDING REMOVAL
CITY OF SEASIDE
MONTEREY COUNTY
CALIFORNIA

Date:	No.:
Scale:	
Design:	
Drawn:	
Approved:	
Job No.:	
Drawing Number:	2-1.01

NOT FOR CONSTRUCTION FOR BID PURPOSES ONLY S201-1TB1, 12-8-17

Plotted - 12/17/2017 9:53:45 AM :: Saved - 12/6/2017 1:42:06 PM :: I:\Projects\Fort Ord Reuse Authority\Surplus II Bldg Demolitions\1-References-Misc\Surplus II 95% Dwg-Specs-Front_End\Drawings\201_F05P06.dwg :: Crown

KEYNOTES (SEE NOTE 12 & 13)

REMOVE:

- 102 CAP AND REMOVE EXISTING GAS LATERAL AND STRUCTURES.
- 104 CAP AND REMOVE EXISTING ELECTRICAL CONDUIT LATERAL AND STRUCTURES.
- 106 CAP AND REMOVE EXISTING TELECOM LATERAL AND STRUCTURES.

PROTECT:

- 201 CAUTION! PROTECT EXISTING OVERHEAD LINES & JOINT POLES
- 203 PROTECT EXISTING GAS LINE AND VALVES
- 204 PROTECT EXISTING ELECTRICAL LINE AND STRUCTURES
- 207 PROTECT EXISTING STREET LIGHT, CONDUIT, AND BOX
- 209 PROTECT EXISTING BUILDING
- 210 PROTECT EXISTING TELECOM LINE AND STRUCTURES

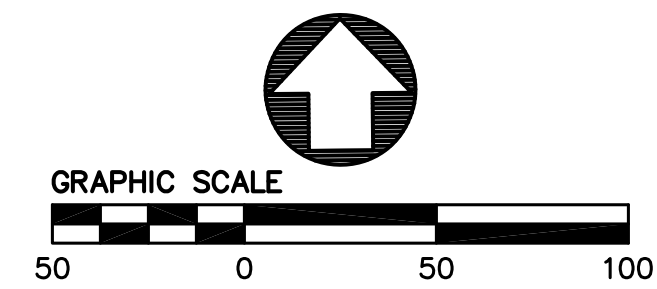
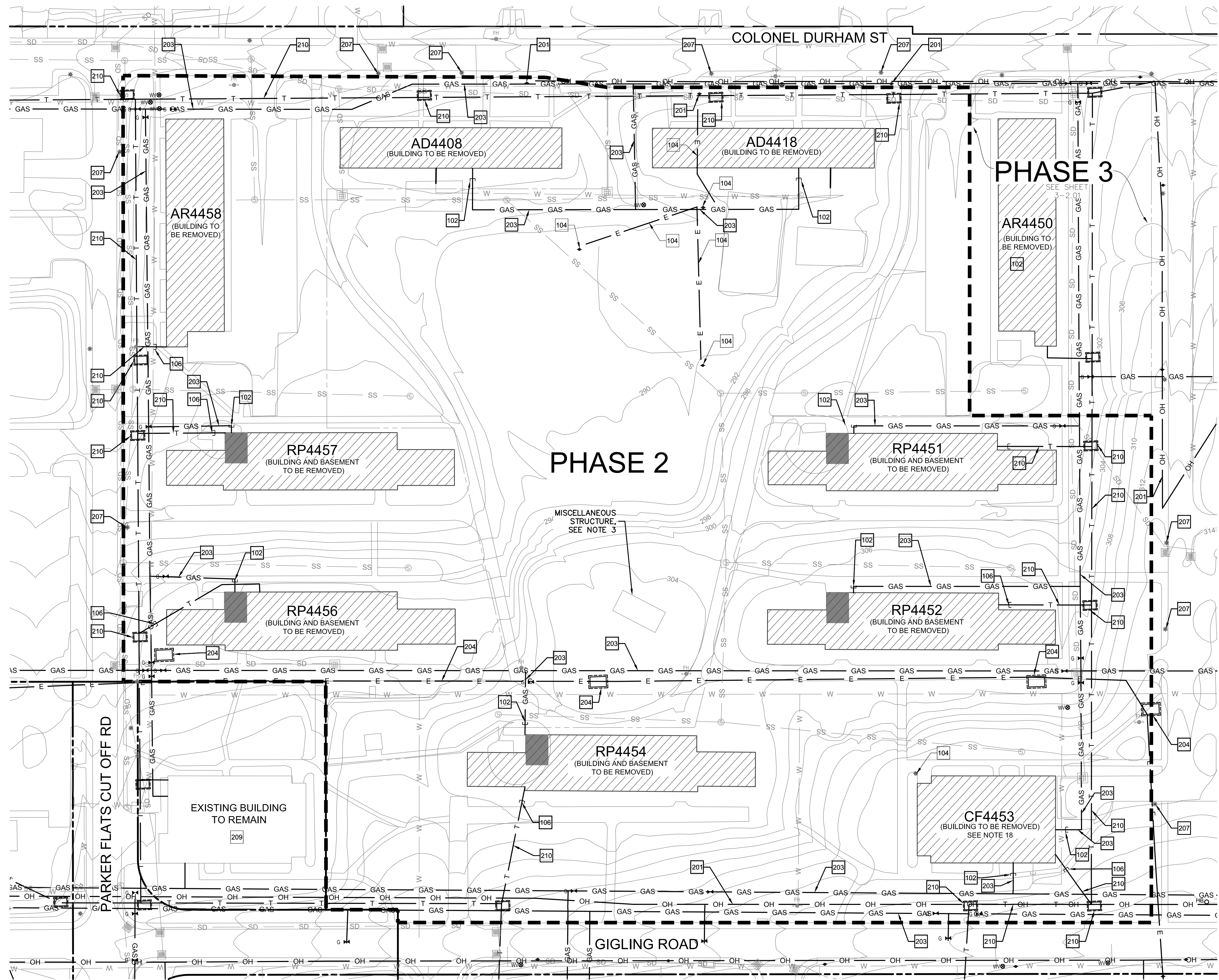

HARRIS & ASSOCIATES
 450 Lincoln Avenue, Suite 103
 Salinas, CA 95901
 (831) 233-9242

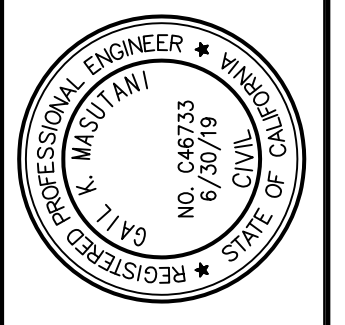
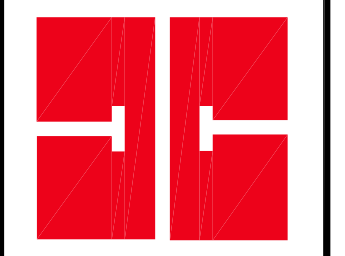

SURPLUS II - BUILDING REMOVAL
PHASE 2 - UTILITY ABANDONMENT/PROTECTION
PLAN (GAS, ELECTRIC, TELEPHONE)
CITY OF SEASIDE MONTEREY COUNTY CALIFORNIA

Revisions	
No.	Date

Date: _____
 Scale: _____
 Design: _____
 Drawn: _____
 Approved: _____
 Job No: _____

Drawing Number:
2-2.01

NOT FOR CONSTRUCTION FOR BID PURPOSES ONLY S201-1TB1, 12-8-17

Plotted - 12/11/2017 2:39:10 PM :: Saved - 12/11/2017 9:58:32 AM :: I:\Projects\Fort Ord Reuse Authority\Surplus II Bldg Demolitions\11-References\Misc\Surplus II 95% Dwg-Specs-Front_End\Drawings\202_FG9PDE.dwg :: Crown

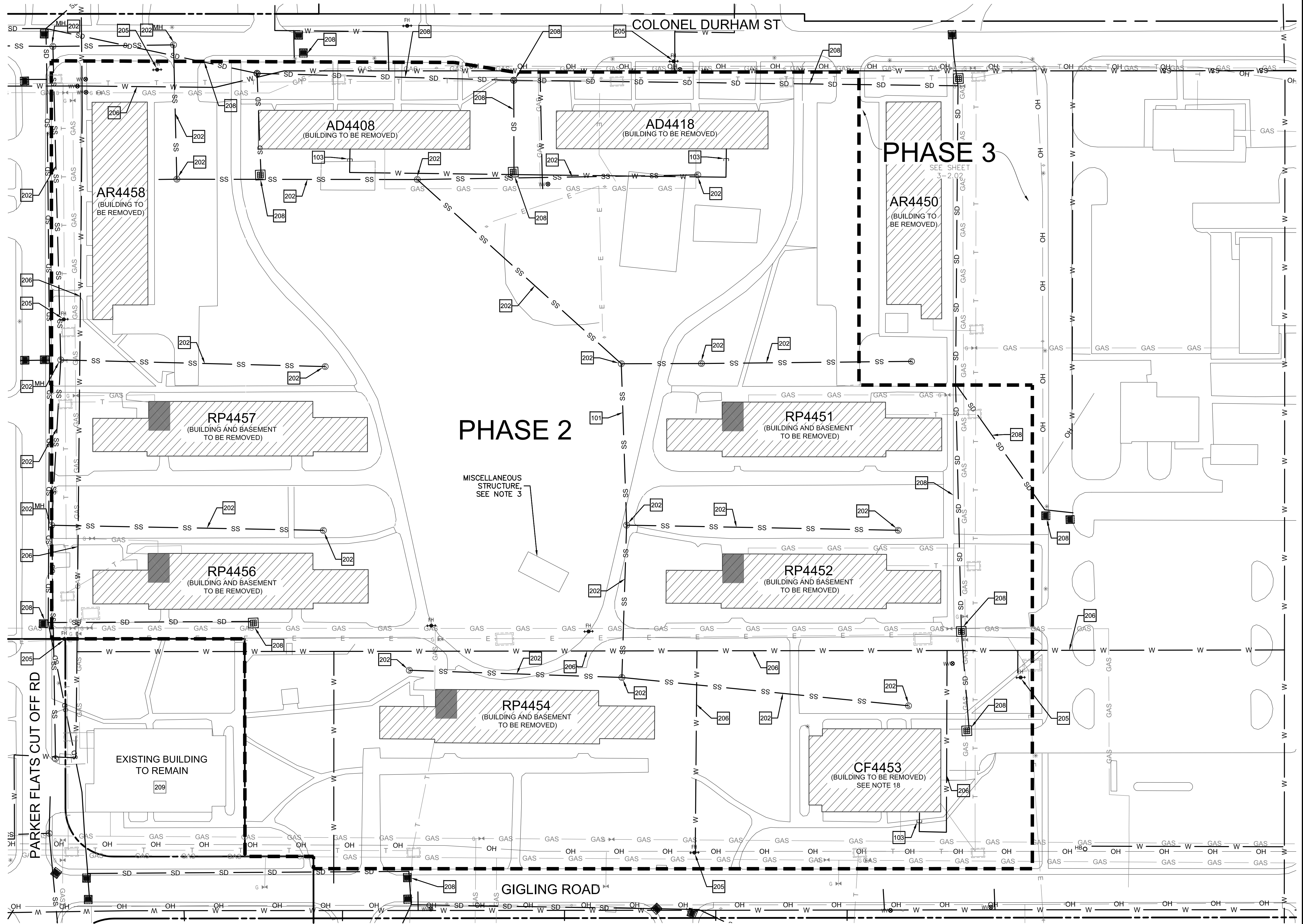

KEYNOTES (SEE NOTE 14)

REMOVE:

- 101 CAP AND REMOVE EXISTING SANITARY SEWER LINES/LATERALS AND STRUCTURES 1
4.01
- 103 CAP AND REMOVE EXISTING WATER LINE AND ASSOCIATED APPARATUS 1
4.01
- 105 EXISTING FIRE HYDRANT. CONTRACTOR TO CONFIRM WITH FORA IF FIRE HYDRANT SHALL BE SALVAGED FOR FUTURE REUSE OR REMOVED FROM SITE.

PROTECT:

- 202 PROTECT EXISTING SANITARY SEWER LINE AND STRUCTURES
- 205 PROTECT EXISTING FIRE HYDRANT
- 206 PROTECT EXISTING WATER LINE AND ASSOCIATED APPARATUS
- 208 PROTECT EXISTING STORM DRAIN LINE AND STRUCTURES SEE EROSION CONTROL PLAN FOR MORE INFORMATION
- 209 PROTECT EXISTING BUILDING

PHASE 2

PHASE 3

MISCELLANEOUS STRUCTURE, SEE NOTE 3

EXISTING BUILDING TO REMAIN

CF4453 (BUILDING TO BE REMOVED) SEE NOTE 18

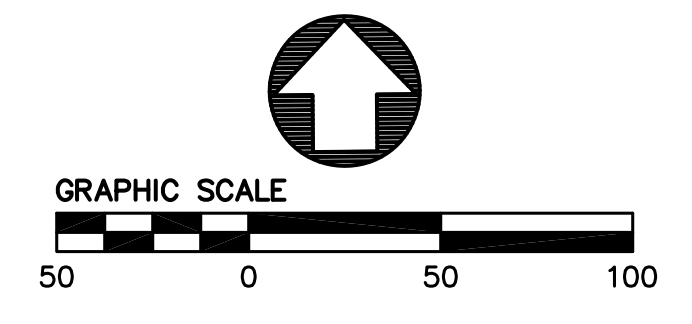

HARRIS & ASSOCIATES
450 Lincoln Avenue, Suite 103
Salinas, CA 95901
(831) 233-9242

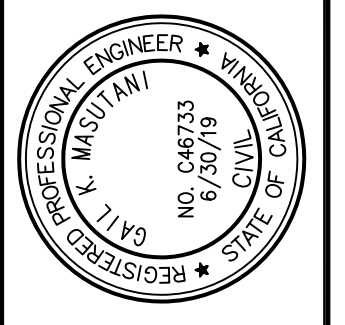
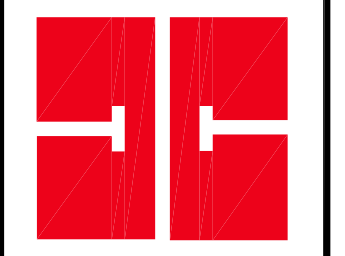

SURPLUS II - BUILDING REMOVAL
PHASE 2 - UTILITY ABANDONMENT/PROTECTION
PLAN (SANITARY SEWER, WATER, STORM DRAIN)
CITY OF SEASIDE MONTEREY COUNTY CALIFORNIA

No.	Date:	Scale:	Design:	Drawn:	Approved:	Job No.:
Drawing Number: 2-2.02						

NOT FOR CONSTRUCTION FOR BID PURPOSES ONLY S201-1TB1, 12-8-17

NOTE

REFER TO SHEET 1.01 FOR EXISTING CONDITIONS AND BUILDING REMOVAL, AND SHEETS 2.01 AND 2.02 FOR UTILITY ABANDONMENT/PROTECTION.

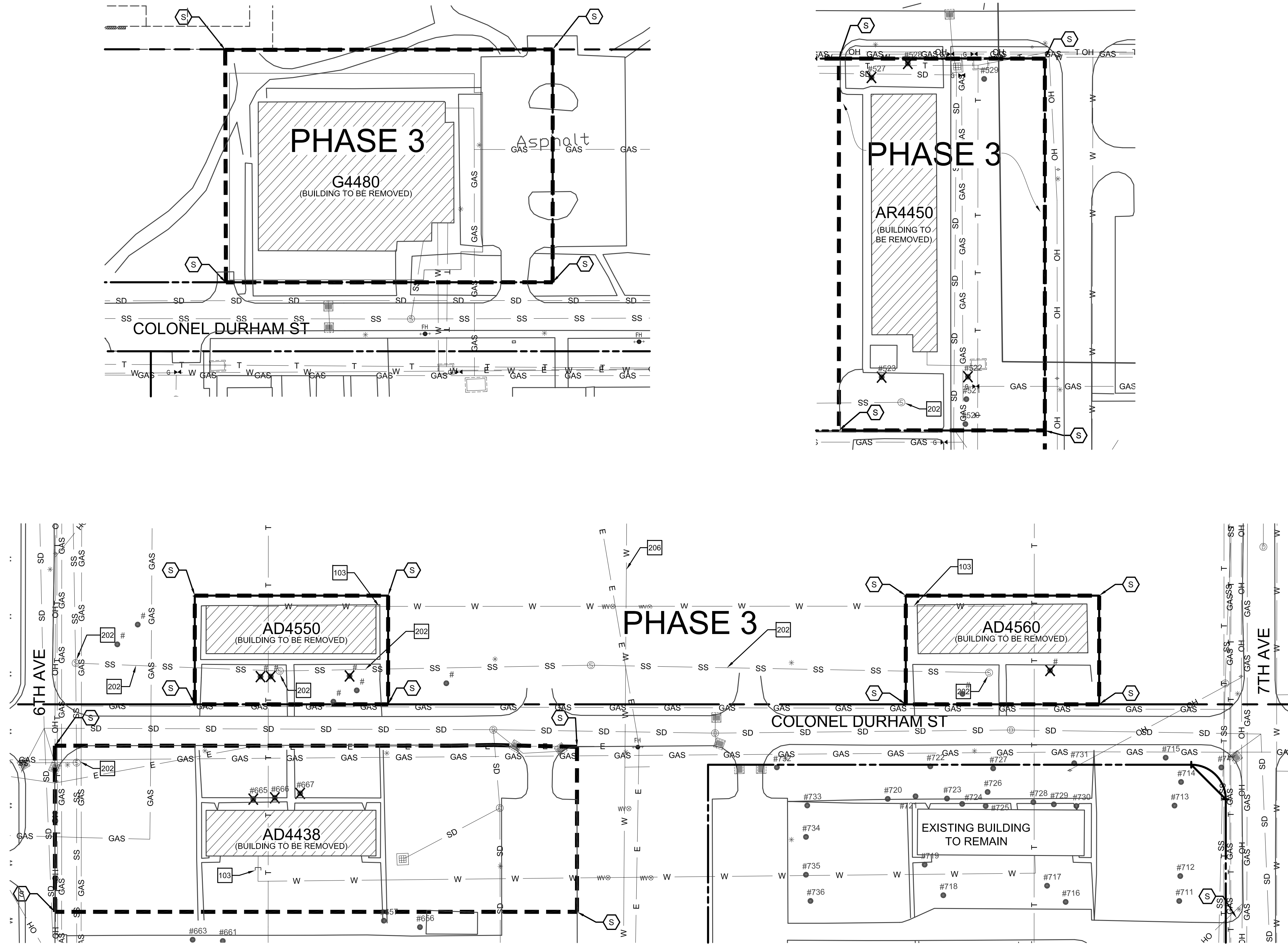

Plotted - 12/11/2017 2:19:47 PM :: Saved - 12/11/2017 9:16:03 AM :: I:\Projects\Fort Ord Reuse Authority\Surplus II Bldg Demolitions\11-References-Misc\Surplus II 95% Dwg-Specs-Front_End\Drawings\101_FOSPDE.dwg :: Crown

HARRIS & ASSOCIATES
 450 Lincoln Avenue, Suite 103
 Salinas, CA 93901
 (831) 233-9242

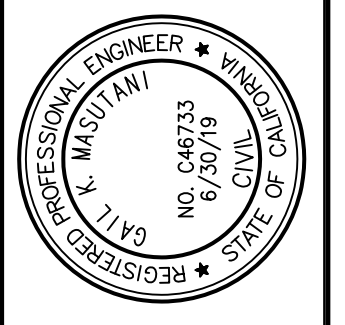
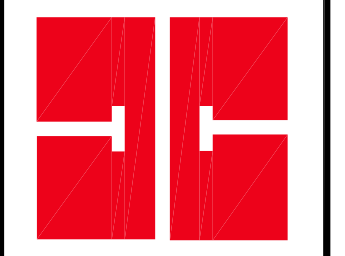

SURPLUS II - BUILDING REMOVAL
PHASE 3 - EXISTING CONDITIONS & BUILDING REMOVAL
CITY OF SEASIDE MONTEREY COUNTY CALIFORNIA

Date:	No.	Revisions

Drawing Number:
3-1.01

NOT FOR CONSTRUCTION FOR BID PURPOSES ONLY S201-1TB1, 12-8-17

Plotted - 12/11/2017 9:54:26 AM :: Saved - 12/6/2017 1:42:06 PM :: I:\Projects\Fort Ord Reuse Authority\Surplus II Bldg Demolitions\1-References-Misc_Surplus II 95% Dwg-Specs-Front-End\Drawings\201_F05PDE.dwg :: Crown

KEYNOTES (SEE NOTE 12 & 13)

REMOVE:

- 102 CAP AND REMOVE EXISTING GAS LATERAL AND STRUCTURES.
- 104 CAP AND REMOVE EXISTING ELECTRICAL CONDUIT LATERAL AND STRUCTURES.
- 106 CAP AND REMOVE EXISTING TELECOM LATERAL AND STRUCTURES.

PROTECT:

- 201 CAUTION! PROTECT EXISTING OVERHEAD LINES & JOINT POLES
- 203 PROTECT EXISTING GAS LINE AND VALVES
- 204 PROTECT EXISTING ELECTRICAL LINE AND STRUCTURES
- 207 PROTECT EXISTING STREET LIGHT, CONDUIT, AND BOX
- 209 PROTECT EXISTING BUILDING
- 210 PROTECT EXISTING TELECOM LINE AND STRUCTURES

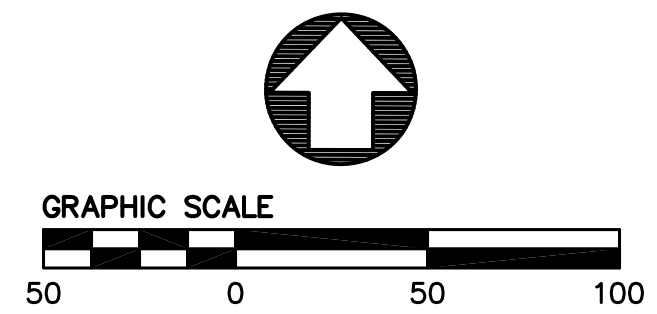
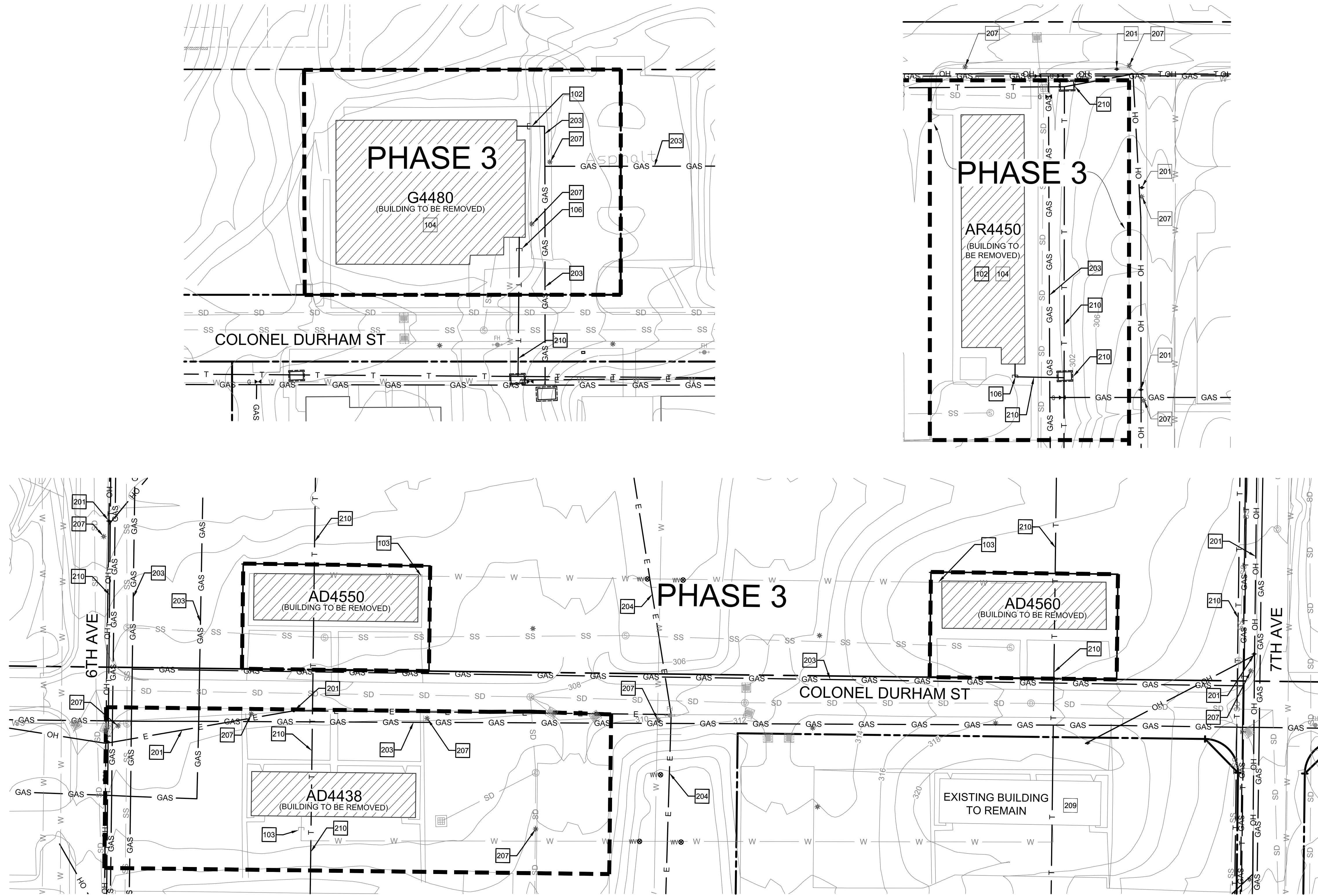

HARRIS & ASSOCIATES
 450 Lincoln Avenue, Suite 103
 Salinas, CA 93901
 (831) 233-9242

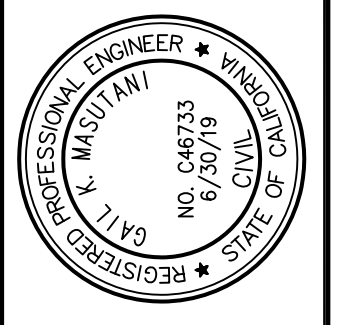
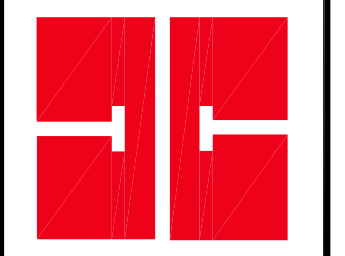

SURPLUS II - BUILDING REMOVAL
PHASE 3 - UTILITY ABANDONMENT/PROTECTION
PLAN (GAS, ELECTRIC, TELEPHONE)
CITY OF SEASIDE, MONTEREY COUNTY, CALIFORNIA

Date:	No.	Revisions

Drawing Number:
3-2.01

NOT FOR CONSTRUCTION FOR BID PURPOSES ONLY S201-1TB1, 12-8-17

Plotted - 12/11/2017 2:45:13 PM :: Saved - 12/11/2017 9:58:32 AM :: I:\Projects\Fort Ord Reuse Authority\Surplus II Bldg Demolitions\11-References\Misc\Surplus II 95% Dwg-Specs-Front_End\Drawings\202_FG9PDE.dwg :: Crown

KEYNOTES (SEE NOTE 14)

REMOVE:

101 CAP AND REMOVE EXISTING SANITARY SEWER LINES/LATERALS AND STRUCTURES 1
4.01

103 CAP AND REMOVE EXISTING WATER LINE AND ASSOCIATED APPARATUS 1
4.01

105 EXISTING FIRE HYDRANT. CONTRACTOR TO CONFIRM WITH FORA IF FIRE HYDRANT SHALL BE SALVAGED FOR FUTURE REUSE OR REMOVED FROM SITE.

PROTECT:

202 PROTECT EXISTING SANITARY SEWER LINE AND STRUCTURES

205 PROTECT EXISTING FIRE HYDRANT

206 PROTECT EXISTING WATER LINE AND ASSOCIATED APPARATUS

208 PROTECT EXISTING STORM DRAIN LINE AND STRUCTURES SEE EROSION CONTROL PLAN FOR MORE INFORMATION

209 PROTECT EXISTING BUILDING

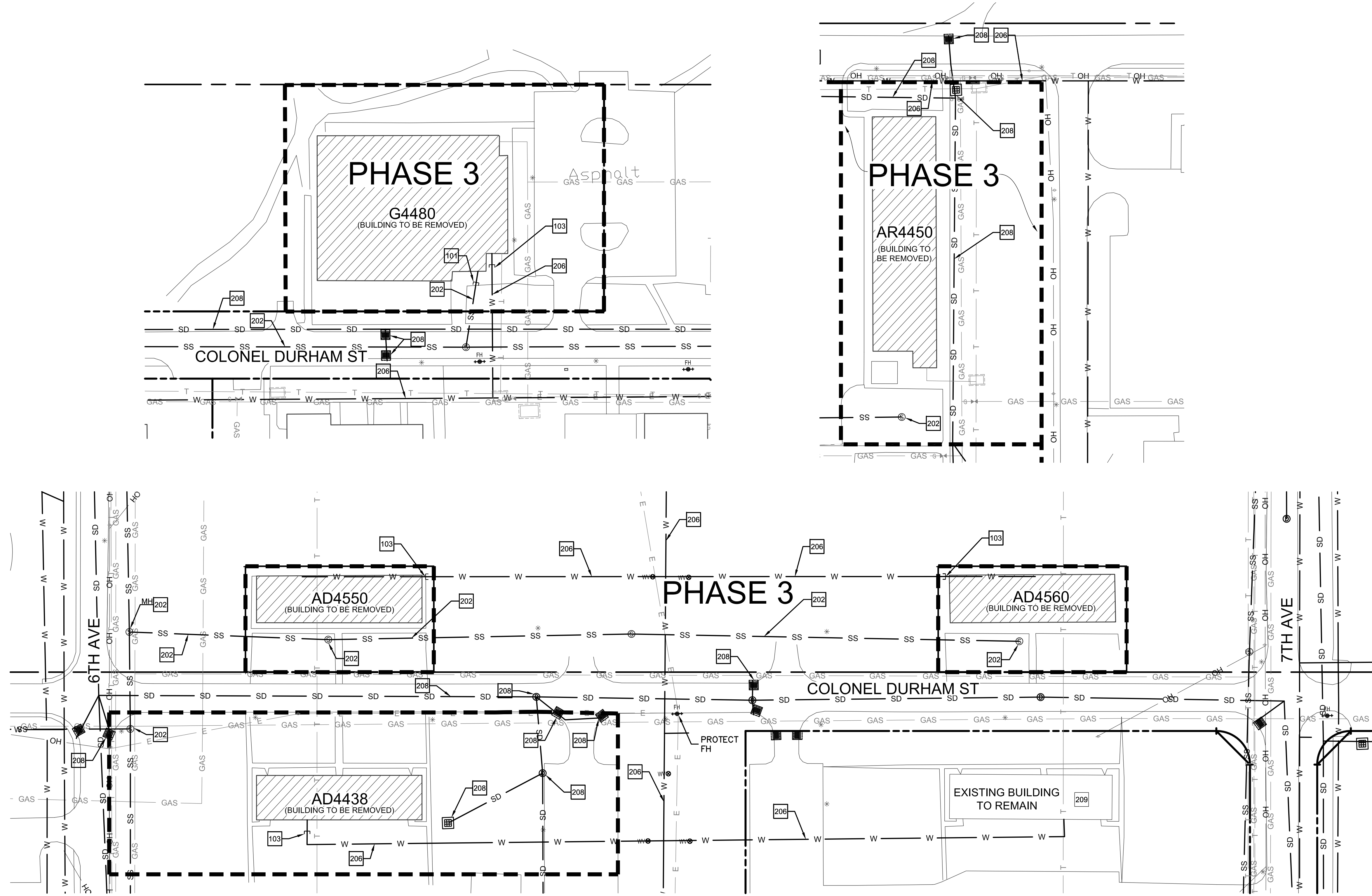

HARRIS & ASSOCIATES
450 Lincoln Avenue, Suite 103
Salinas, CA 93901
(831) 233-9242

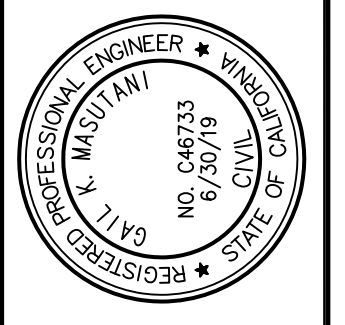
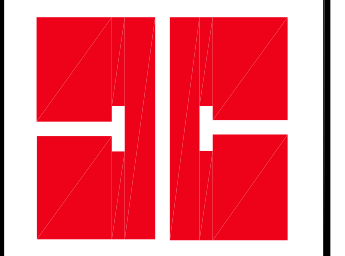

SURPLUS II - BUILDING REMOVAL
PHASE 3 - UTILITY ABANDONMENT/PROTECTION
PLAN (SANITARY SEWER, WATER, STORM DRAIN)
CITY OF SEASIDE MONTEREY COUNTY CALIFORNIA

Revisions	
No.	Date

Drawing Number:
3-2.02

NOT FOR CONSTRUCTION FOR BID PURPOSES ONLY S201-1TB1, 12-8-17

Plotted - 12/11/2017 2:46:55 PM :: Saved - 12/11/2017 9:21:29 AM :: I:\Projects\For Ord Reuse Authority\Surplus II Bldg Demolitions\11-References\Misc\Surplus II 95% Dwg-Specs-Front_End\Drawings\301_FOGPER.dwg :: Crown

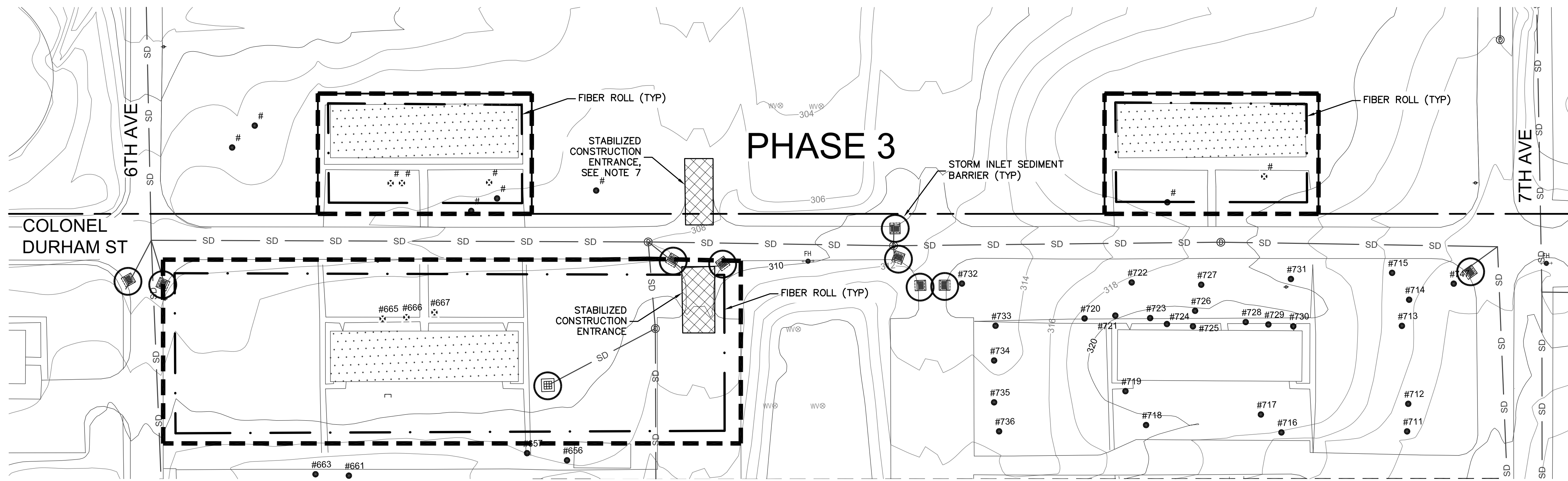
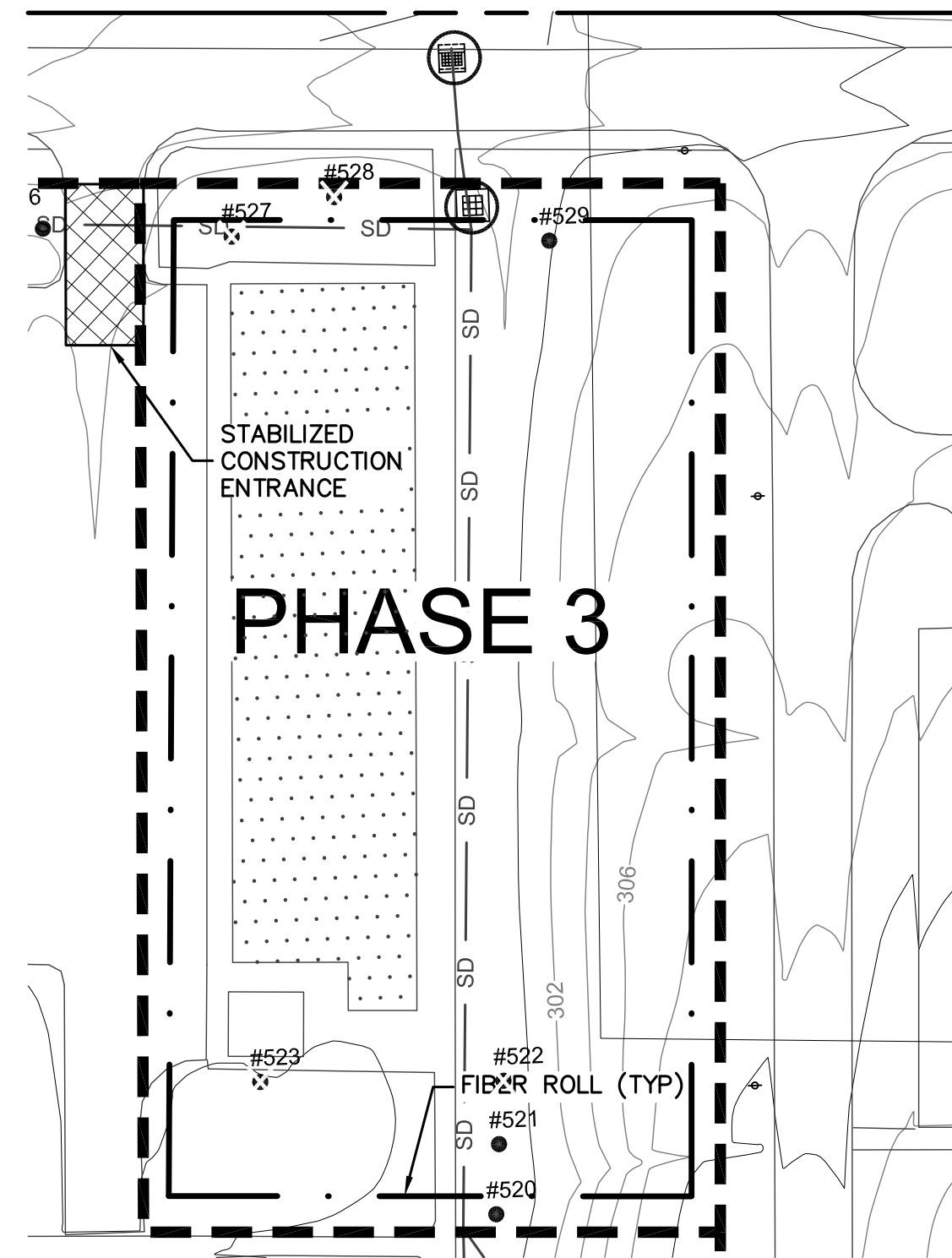
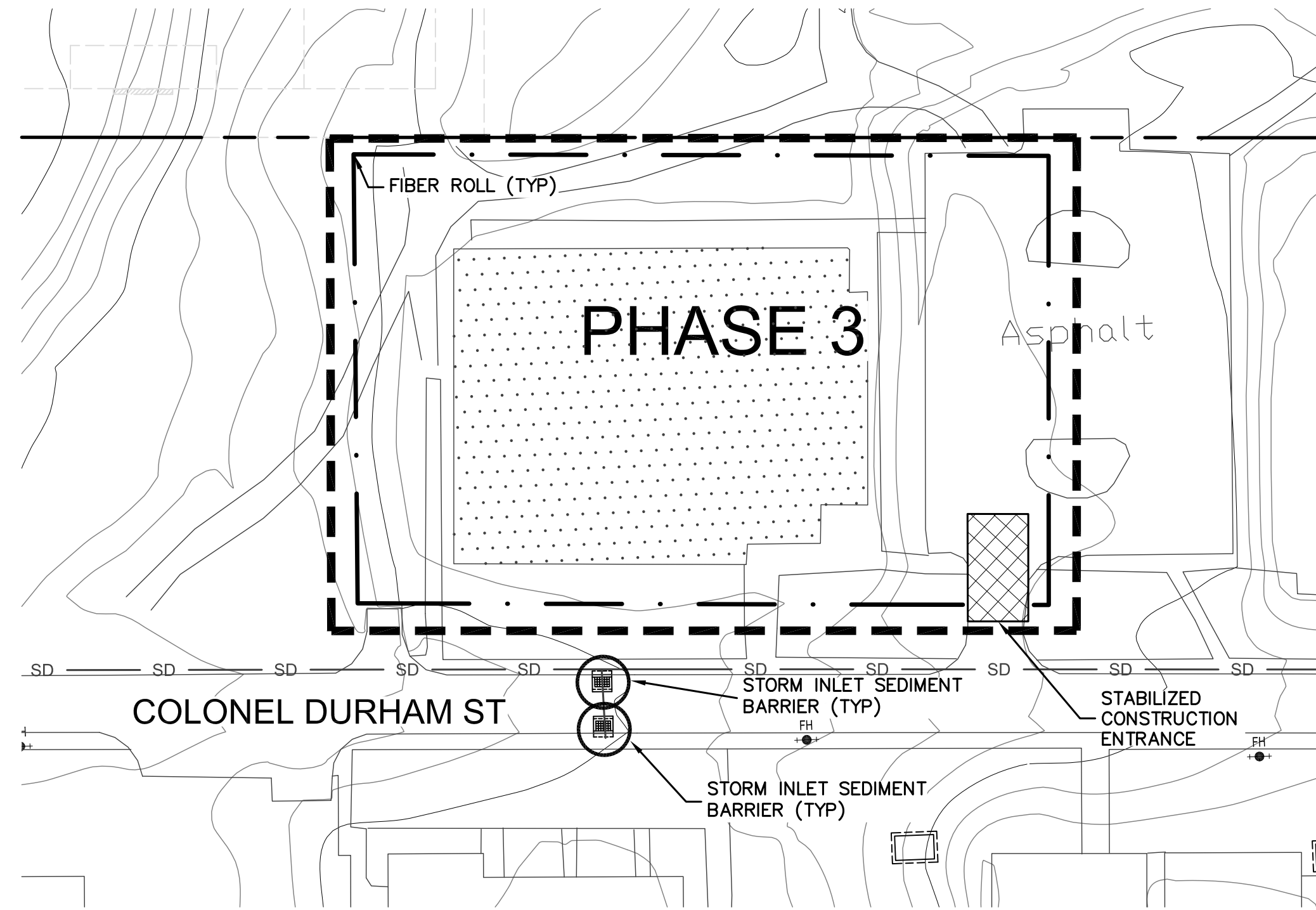

LEGEND

- LIMIT OF WORK
- FIBER ROLL $\frac{2}{3.02}$
- STABILIZED CONSTRUCTION ENTRANCE $\frac{3}{3.02}$
- STORM INLET SEDIMENT BARRIER $\frac{1}{3.02}$
- HYDROSEED PER CASQA BMP EC-4, SEE NOTE 6
- #25 EXISTING TREE AND ID NUMBER

NOTES

1. STABILIZED CONSTRUCTION ENTRANCE IS SHOWN FOR REFERENCE ONLY.
2. CONTRACTOR TO MAINTAIN/REVISE EROSION CONTROL MEASURES AS NEEDED TO PROTECT AND PREVENT SEDIMENT FROM LEAVING THE SITE DURING VARIOUS STAGES/PHASES OF REMOVAL NOT SHOWN ON THE EROSION CONTROL PLAN. CONTRACTOR TO COMPLY WITH SWPPP AT ALL TIMES.
3. CONTRACTOR SHALL SWEEP THE PUBLIC ROAD IN THE VICINITY OF THE ENTRANCE AS OFTEN AS NECESSARY THROUGHOUT THE WORK DAY TO COMPLETE REMOVE ALL DEBRIS ASSOCIATED WITH PROJECT ACTIVITIES.
4. CONTRACTOR TO ADD SEDIMENT BARRIER TO ALL PERIMETER STORM DRAIN INLETS THAT ACCEPT RUNOFF FROM SITE.
5. EXISTING CONTOURS AND ELEVATIONS SHOWN FOR REFERENCE ONLY AND WERE BASED ON GIS INFORMATION PROVIDED BY FORA AND AERIAL PHOTOGRAPHY, REFERENCED TO NAVD88 WITH A ±2-FT LEVEL OF ACCURACY.
6. WHERE NATURAL VEGETATION HAS BEEN REMOVED, PROVIDE HYDROSEEDING PER CASQA BMP EC-4.
7. FOR CONTRACTOR TO CONFIRM THAT FORA HAS RECEIVED PERMISSION FROM CSUMB PRIOR TO ASSESSING THEIR PROPERTY FOR WORK IN THE AREA OF BUILDING AD4550 AND AD4560.

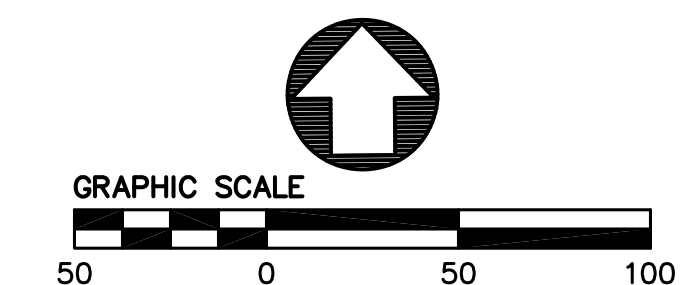

HARRIS & ASSOCIATES
 450 Lincoln Avenue, Suite 103
 Salinas, CA 93901
 (831) 233-9242

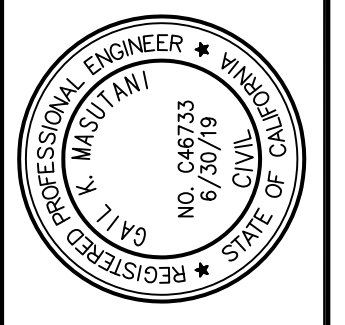
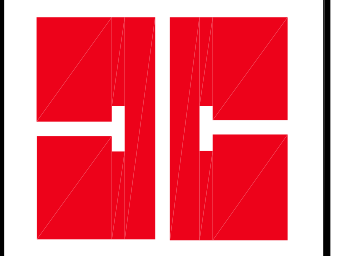

SURPLUS II - BUILDING REMOVAL
 PHASE 3 - EROSION CONTROL PLAN
 CITY OF SEASIDE MONTEREY COUNTY CALIFORNIA

Revisions	
No.	Date

Date: _____
 Scale: _____
 Design: _____
 Drawn: _____
 Approved: _____
 Job No: _____

Drawing Number: 3-3.01

NOT FOR CONSTRUCTION FOR BID PURPOSES ONLY S201-1TB1, 12-8-17

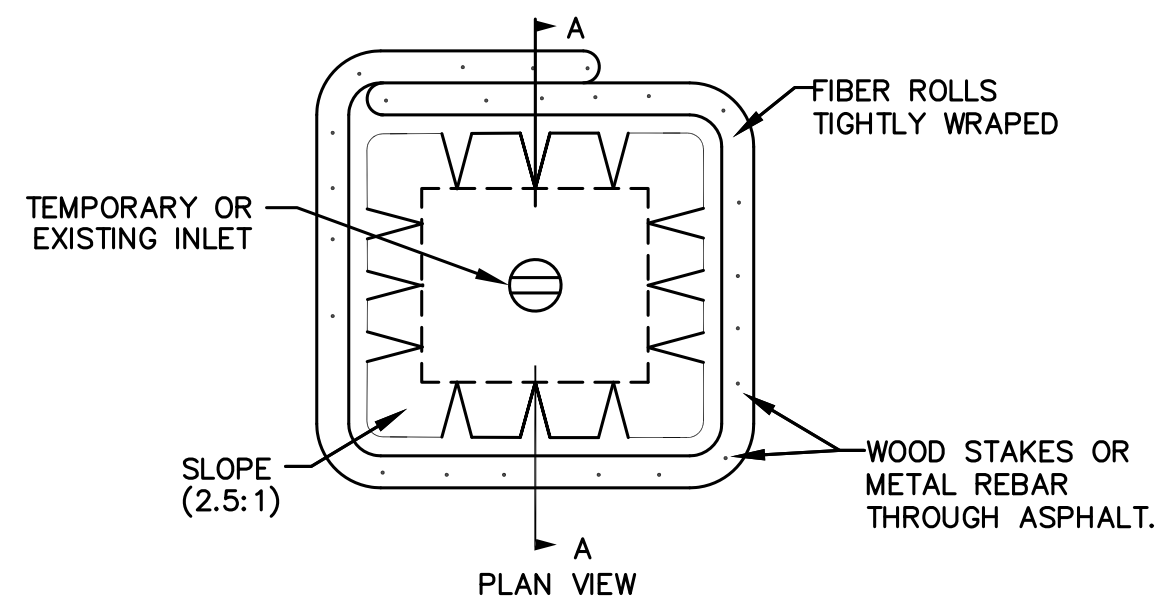

NOTES:

1. USE INSERTS AT ALL INLETS.
2. INSERTS TO BE INSPECTED AND CLEANED WEEKLY AND AFTER EVERY RAIN EVENT.
3. EMPTY DROP INLET FILTERS WHEN FILTERS APPEAR TO BE HALF FULL.
4. DISPOSE OF TRAPPED SEDIMENT IN ACCORDANCE WITH LOCAL REQUIREMENTS.
5. PLACE FIBER ROLLS AROUND THE INLET CONSISTENT WITH BASIN SEDIMENT BARRIER DETAIL ON THIS SHEET. USE REED & GRAHAM, INC. GEOSYNTHETICS STRAW WATTLE FIBER ROLL (COMES IN 9" X 25' ROLLS) OR EQUIVALENT.
6. FIBER ROLL INSTALLATION REQUIRES THE PLACEMENT AND SECURE STAKING OF THE FIBER ROLL IN A TRENCH, 3"- 5" DEEP, DUG ON CONTOUR. RUNOFF MUST NOT BE ALLOWED TO RUN UNDER OR AROUND FIBER ROLL.
7. THE TOP OF THE STRUCTURE (PONDING HEIGHT) MUST BE WELL BELOW THE GROUND ELEVATION DOWNSLOPE TO PREVENT RUNOFF FROM BY-PASSING THE INLET. EXCAVATION OF A BASIN ADJACENT TO THE DROP INLET OR A TEMPORARY DIKE ON THE DOWNSLOPE OF THE STRUCTURE MAY BE NECESSARY.
8. SEDIMENT BASIN PER BMP SE-2

1 DROP INLET SEDIMENT BARRIER
NTS

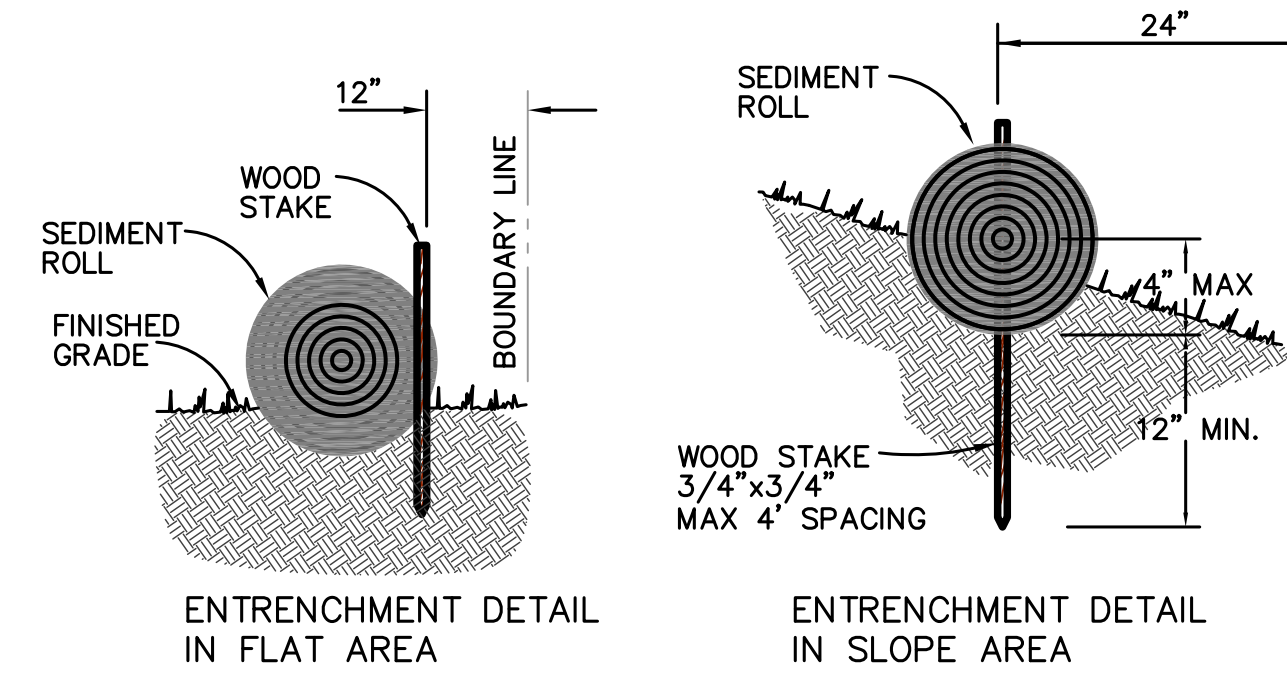

INSTALLATION PROCEDURE

1. FIBER ROLLS ARE TUBES MADE FROM POROUS BIODEGRADABLE FIBER STUFFED IN A PHOTO-DEGRADABLE OPEN WEAVE NETTING. THEY ARE APPROX. 8" DIAMETER.
2. FIBER ROLL INSTALLATION REQUIRES THE PLACEMENT AND SECURE STAKING OF THE ROLL IN A TRENCH, 2"-4" DEEP, DUG ON CONTOUR. RUNOFF MUST NOT BE ALLOWED TO RUN UNDER OR AROUND ROLL. ROLLS SHOULD BE ABUTTED SECURELY TO PROVIDE A TIGHT JOINT, NOT OVERLAPPED.
3. FIBER ROLL BARRIER - FIBER ROLL BARRIERS SHALL BE PROVIDED AS REQUIRED BY THE CONSTRUCTION GENERAL PERMIT. AT A MINIMUM, FIBER ROLLS SHALL BE PROVIDED (1) ON DISTURBED SLOPES AND (2) PERPENDICULAR TO ALL CONCENTRATED FLOW PATHS. ON EMBANKMENTS, FIBER ROLL BARRIERS SHALL BE PLACED ON CONTOUR WITH AN ELEVATION DEVIATION OF NO MORE THAN 2 INCHES EXCEPT AT END TERMINATION POINTS. END TERMINATIONS SHALL BE AT LEAST 6-INCHES HIGHER IN ELEVATION THAN THE REMAINING FIBER ROLL WHERE FEASIBLE. FIBER ROLLS SHALL BE CONNECTED BY WRAPPING ENDS WITH MINIMUM 18-INCH OVERLAP.

2 FIBER ROLL
NTS

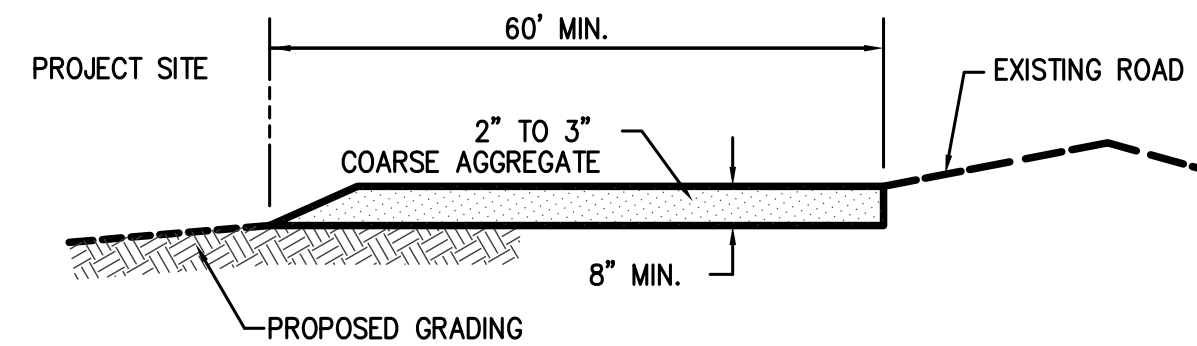

NOTES:

1. THE LOCATIONS SHOWN ARE FOR INFORMATION ONLY. THE CONTRACTOR IS RESPONSIBLE FOR LOCATING STABILIZED CONSTRUCTION ENTRANCES AS CONSTRUCTION PHASES DICTATE. AS AN OPTION, CONTRACTOR MAY USE WHEEL WASHERS. IF WHEEL WASHING IS USED, ALL WATER MUST BE EITHER RECYCLED, INFILTRATED OR OTHERWISE USED ON-SITE. ALL CONSTRUCTION ENTRANCES SHALL BE MAINTAINED IN A CONDITION THAT WILL PREVENT TRACKING OR FLOWING OF SEDIMENT ONTO PUBLIC RIGHTS-OF-WAY. A STABILIZED CONSTRUCTION ENTRANCE SHALL BE PROVIDED FOR REDUCING THE AMOUNT OF MUD THAT IS TRACKED FROM THE SITE TO THE STORM DRAIN SYSTEM. THIS MAY REQUIRE PERIODIC TOP DRESSING WITH ADDITIONAL STONE AS CONDITIONS DEMAND, AND REPAIR AND/OR CLEANOUT OF ANY MEASURES USE TO TRAP SEDIMENT. ALL SEDIMENT SPILLED, DROPPED, WASHED OR TRACKED ONTO PUBLIC RIGHTS-OF-WAY SHALL BE REMOVED IMMEDIATELY.
2. WHEN NECESSARY, WHEELS SHALL BE CLEANED TO REMOVE SEDIMENT PRIOR TO ENTRANCE ONTO PUBLIC RIGHTS-OF-WAY. WHEN WASHING IS REQUIRED, IT SHALL BE DONE ON AN AREA STABILIZED WITH CRUSHED STONE THAT DRAINS INTO AN APPROVED SEDIMENT TRAP OR SEDIMENT BASIN. ALL SEDIMENT SHALL BE PREVENTED FROM ENTERING ANY STORM DRAIN, DITCH OR WATERCOURSE THROUGH USE OF INLET PROTECTION (E.G. SAND BAGS OR OTHER APPROVED METHODS).
3. THE MATERIAL FOR CONSTRUCTION OF THE PAD SHALL BE 2" TO 3" COARSE AGGREGATE.
4. THE THICKNESS OF THE PAD SHALL NOT BE LESS THAN 8".
5. THE WIDTH OF THE PAD SHALL NOT BE LESS THAN THE FULL WIDTH OF ALL POINTS OF INGRESS OR EGRESS (12' MIN).
6. THE LENGTH OF THE PAD SHALL BE AS REQUIRED, BUT NOT LESS THAN 60'.

3 STABILIZED CONSTRUCTION ENTRANCE
NTS

HARRIS & ASSOCIATES
450 Lincoln Avenue, Suite 103
Salinas, CA 93901
(831) 233-9242

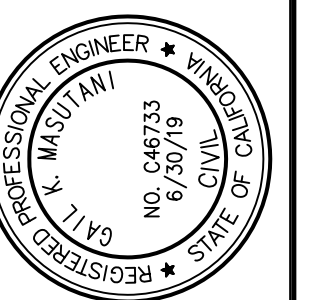
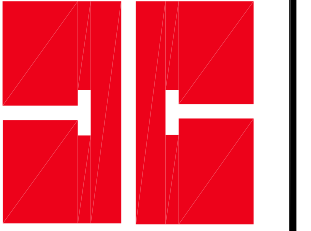

SURPLUS II - BUILDING REMOVAL
EROSION CONTROL DETAILS
CITY OF SEASIDE MONTEREY COUNTY CALIFORNIA

Revisions	
No.	Date

Date: _____
Scale: _____
Design: _____
Drawn: _____
Approved: _____
Job No: _____
Drawing Number: 3.02

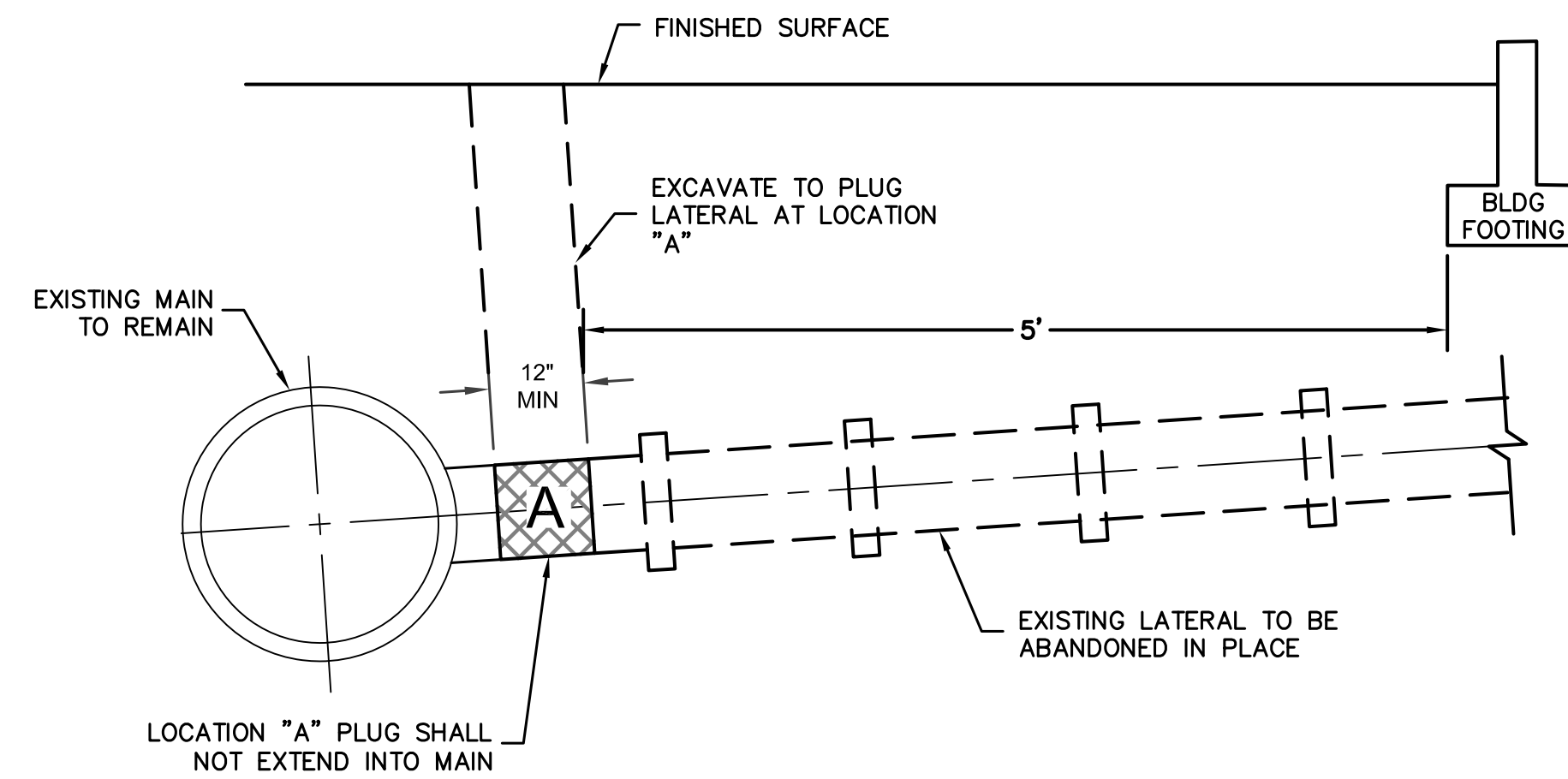

SCENARIO B: ADJACENT TO BUILDING

NOTES

1. ALL PLUGS SHALL BE CONCRETE.
2. LATERALS LARGER THAN 6" IN DIAMETER SHALL BE PLUGGED AND FILLED WITH CEMENT SLURRY IN ACCORDANCE WITH SECTION 19-3.03F OF THE CALTRANS STANDARD SPECIFICATIONS.
3. SEE PROJECT SPECIFICATIONS FOR REMOVAL AND/OR HANDLING OF ASBESTOS CONTAINING MATERIAL.

1 WATER & SEWER UTILITY CAP
NTS

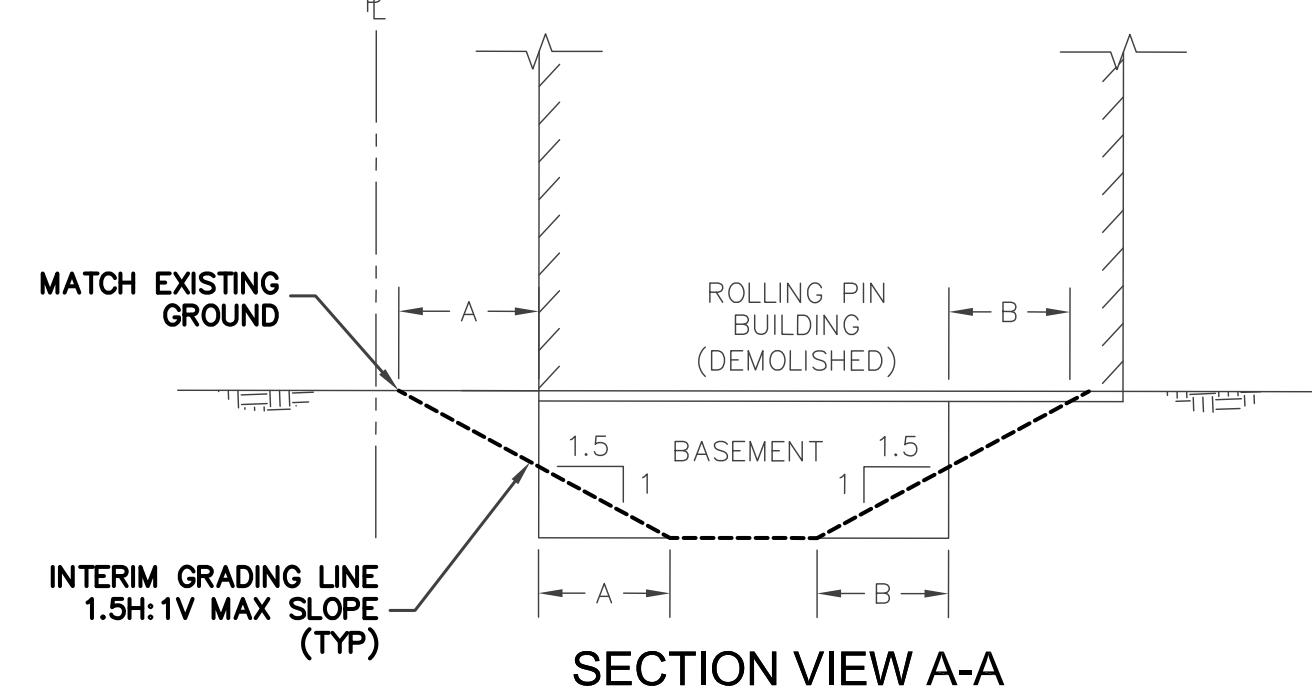
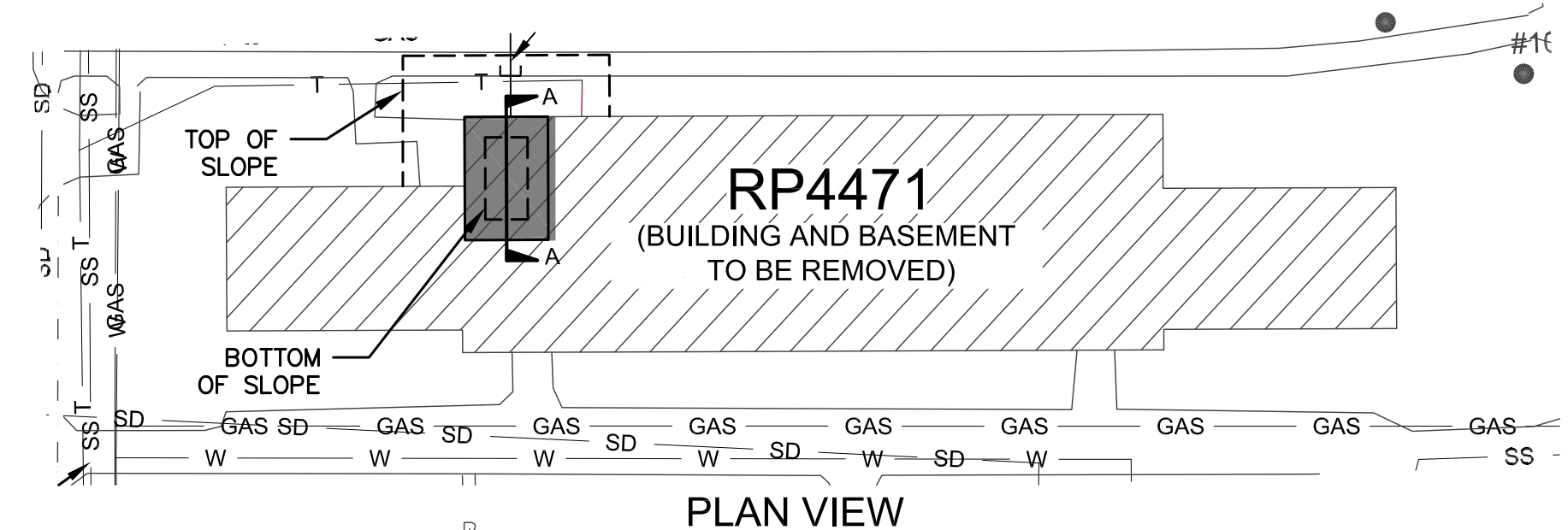

NOTES

1. CONTRACTOR TO REMOVE SLAB AT THE BOTTOM OF BUILDINGS. BASEMENTS AND CRAWL SPACES ARE SHOWN FOR INFORMATIONAL PURPOSES ONLY. CONTRACTOR IS RESPONSIBLE TO VERIFY BASEMENT AND CRAWL SPACE INFORMATION FOR BIDDING AT THEIR EXPENSE.
2. PROVIDE TEMPORARY BUILDING REMOVAL CONDITION BY ROUGH GRADING A 1.5H:1V SLOPE FROM BOTTOM OF BASEMENT TO EXISTING GROUND. REFER TO SECTION A-A FOR GENERAL BASEMENT LOCATION AND ILLUSTRATION OF BASEMENT EXCAVATION.
3. GRADING AND EXCAVATION FOR ROLLING PIN BUILDINGS MUST BE WITHIN THE PROPERTY LIMITS. CONTRACTOR TO PAY SPECIAL ATTENTION TO ROLLING PIN BUILDINGS THAT ARE CLOSE TO THE PROPERTY LIMITS TO AVOID UNDERCUTTING ROAD(S).
4. CONTRACTOR TO FILL HOLES LEFT BY BUILDING REMOVAL, INCLUDING WHERE THERE ARE BASEMENTS AND CRAWL SPACES, WITH EITHER IMPORTED CLEAN FILL OR BY UTILIZING CRUSHED BUILDING MATERIALS. FILL MATERIAL TO CONFORM TO SPECIFICATIONS PROVIDED BY PROJECT GEOTECHNICAL ENGINEER.

2 ROLLING PIN BASEMENT EXCAVATION
NTS

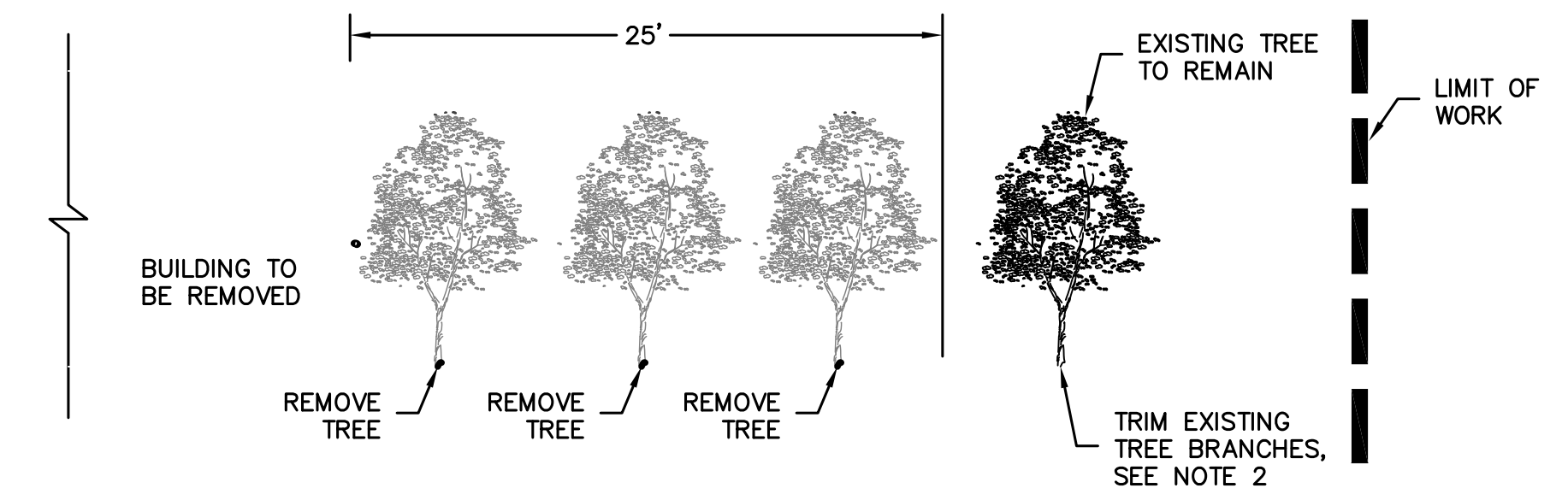

NOTES

1. TREE LOCATIONS ARE APPROXIMATE. CONTRACTOR TO FIELD VERIFY LOCATION OF AND REMOVE TREES AND STUMPS WITHIN 25-FT OF BUILDINGS DESIGNATED FOR REMOVAL. ALL OTHER TREES TO REMAIN UNLESS OTHERWISE NOTED. REFER TO "FORT ORD SURPLUS BUILDING REMOVAL TREE SURVEY" BY FRANK ONO, CERTIFIED ARBORIST #536, FOR ADDITIONAL INFORMATION.
2. CONTRACTOR TO LIMB ALL TREES TO REMAIN, WITHIN LIMIT OF WORK, FROM GROUND TO NINE FEET ABOVE TREE BASE.
3. CONTRACTOR TO LIMB ALL TREES TO REMAIN, WITHIN LIMIT OF WORK, FROM GROUND TO NINE FEET ABOVE TREE BASE. REMOVE TREES UNDER 9-FT IN HEIGHT AND SMALLER THAN 4-INCHES IN DIAMETER AT 5-FT ABOVE GROUND SURFACE.

3 TREE REMOVAL
NTS

HARRIS & ASSOCIATES
450 Lincoln Avenue, Suite 103
Salinas, CA 93901
(831) 233-9242

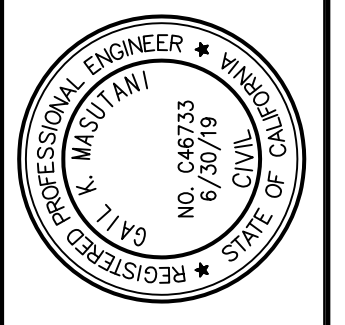
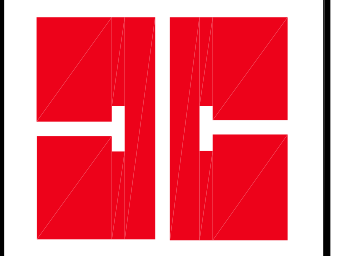

SURPLUS II - BUILDING REMOVAL
CONSTRUCTION DETAILS
CITY OF SEASIDE MONTEREY COUNTY CALIFORNIA

Revisions	
No.	Description

Date: _____
Scale: _____
Design: _____
Drawn: _____
Approved: _____
Job No: _____
Drawing Number:
4.01

NOT FOR CONSTRUCTION FOR BID PURPOSES ONLY S201-1TB1, 12-8-17

S201-ITB2, Volume 2 - SECTION 01 11 00 – SUMMARY OF WORK

PART 1 - GENERAL

1.01 RELATED DOCUMENTS

- A Construction Drawings, Technical Specifications, Addenda, and Contract Agreement, including any Addenda, including other Division 1 Specification Sections, apply to this Section.

1.02 WORK INCLUDED IN THE CONTRACT

- A. Work Included in the Contract, includes, but is not limited to the following: In general, work will consist of the demolition of ten (10) three story, concrete, surplus military structures (nicknamed Rolling pins), one (1) Cafeteria, one (1) Gym with ancillary building, two (2) Armories, and five (5) Administrative buildings located within the area called Surplus II.
 1. Site preparation.
 2. Site utilities.
 3. Site fencing and site appurtenances.
 4. Environmental protection.
 5. Coordination of work being performed by others under separate contracts with FORA, described in Article below titled "CONCURRENT WORK UNDER SEPARATE CONTRACTS."

1.03 CONCURRENT WORK UNDER SEPARATE CONTRACTS

- A. Work Under Separate Contracts: FORA has S201-ITB1 Surplus II Hazardous Material Removal for the building that are to be demolished under this Contract. The Contractor shall coordinate with the Hazardous Material Removal Contactor for schedule and work areas.
- B. Relationship to Work Under the Contract: Work under the Contract shall include all provisions necessary to make such concurrent work under separate contracts complete in every respect and fully functional, including field finishing. Provide necessary backing, supports, piping, conduit, conductors and other such provisions from point of service to point of connection, as shown on Drawings and specified herein.
- C. Documents for Work Under Separate Contracts: FORA Construction Manager will make available, in a timely manner, drawings and specifications of work under separate contracts for coordination and further description of that work.
 1. If available, such information will include drawings, specifications, product data, lists and construction schedules for such work.
 2. Information concerning work under separate contracts or directly by University will be provided for convenience only and shall not to be considered Contract Documents.
- D. Permits, Notices and Fees for Work under Separate Contracts: Notices required by and approvals required of, authorities having jurisdiction over work under separate contracts and related fees, will be solely the responsibility of FORA.

1.04 PROTECT THE WORK FROM VANDALISM

- A. During Work Hours. Protect the Work from theft, vandalism, and unauthorized entry. The Contractor shall have the sole responsibility for job site security.
- B. During Off-Work Hours. During all hours that Work is not being prosecuted, furnish such watchman's services as Contractor may consider necessary to safeguard materials and equipment in storage on the Project site, including Work in place and in process of fabrication, against theft, acts of malicious mischief, vandalism, and other losses or damages.

1.05 PERMITS, LICENSES AND FEES

- A. Licenses: Contractor shall obtain and pay all licenses associated with construction activities, such as business licenses, contractors' licenses and vehicle and equipment licenses. All costs for licenses shall be included in the Contract Amount.

PART 2 – PRODUCTS (NOT USED)

PART 3 – EXECUTION (NOT USED)

END OF SECTION 01 11 00

S201-ITB2, Volume 2 - SECTION 01 14 00 –WORK RESTRICTIONS

PART 1 - GENERAL

1.01 RELATED DOCUMENTS

- A. Construction Drawings, Technical Specifications, Addenda, and Contract Agreement, including any Addenda, including other Division 1 Specification Sections, apply to this Section.

1.02 CONTRACTOR'S USE OF PREMISES AND SITE, GENERAL

- B. Contractor's Use of Premises and Site, General: Refer to Article 2 of the Contract Agreement.

1.03 USE OF PREMISES

- C. Use of Site: Limit use of premises to work within the limits of Work as indicated in the Drawings. Do not disturb portions of site the Construction site.

Where existing buildings and site areas are outside of the limits of Work, make provisions to continued use by scheduling and sequencing of Work under the Contract. Make provisions for temporary barriers, enclosures, covers, directional signage and other construction facilities and temporary controls to enable continuing use.

1.04 CONTRACTOR'S USE OF PROJECT AREA

- D. Location of Work: The Work shall be accomplished within the limits of Work as indicated on Drawings. Use of other areas shall be subject to approval by FORA Construction Manager.

1. Contractor shall not unreasonably encumber the site with materials or equipment.
2. Contractor shall assume full responsibility for protection and safekeeping of products stored on the premises.
3. Contractor shall move any stored products which interfere with operations of FORA or contractors performing work under separate contracts for FORA.
4. Temporary closures or restrictions of use of public thoroughfares, necessary to accomplish the Work, shall be made only as approved in advance by public safety and parking authorities having jurisdiction.

- E. Contractor's Use of the Project Area: Unless otherwise specified or indicated on the Drawings, during the construction period the Contractor shall have full use of the area delineated by the limits of Work as indicated on the Drawings. FORA shall have the right to perform construction operations with its own forces or to employ separate contractors on portions of the Project in accordance with the Article 5 of the Contract Agreement.

- C. Protection of Existing Improvements and Facilities: Contractor shall protect property adjacent to the Project Area and all existing improvements and facilities within the Project Area, including paving and landscaping indicated to remain.

1. All existing improvements and facilities, except those specifically indicated for removal or reconstruction, shall be protected with temporary barriers, enclosures and passageways.

Refer to additional requirements specified in Section 01 56 00 - Temporary Barriers and Enclosures.

2. After completion of Work, existing improvements and facilities shall be restored to original condition and location. Project Area shall be cleaned and restored to presentable condition, equivalent to or better than the condition prior to start of Work.
 3. Should existing improvements and facilities be damaged or soiled beyond renovation or repair, new products shall be provided by Contractor equivalent to existing products, as directed by the FORA Construction Manager.
- D. Project Area Access: The Contractor is allowed to use City streets to access Project Site. Do not restrict access to adjacent facilities and do not restrict access for those performing work under separate contracts for FORA.
1. Access to and egress from Project Site shall be in strict conformance to prearranged routes approved by FORA Construction Manager, with the understanding that curtailment of construction traffic or alternate access routes may be required on short notice if because of excessive noise or problems of safety.
 2. Driveways and Entrances: Keep driveways and entrances serving premises clear and available to service and emergency vehicles at all times. Do not use these areas for parking or storage of materials.
 - a. Schedule deliveries to minimize use of driveways and entrances.
 - b. Schedule deliveries to minimize space and time requirements for storage of materials and equipment on-site.
- F. Emergency Access: Provide pathways, drives, gates, directional signage and other provisions as required by authorities having jurisdiction for emergency access to Project Area and adjoining campus facilities.
- G. Emergency Egress: Maintain all pathways, drives, gates, and other means of egress during construction as required by public safety authorities having jurisdiction.

1.05 TIME RESTRICTIONS

- A. Hours of operation are stated in Article 2.24 of the Contract Agreement.
- B. Utility Outages and Shutdown: Schedule utility outages and shutdowns to nights, weekends, holidays or times and dates acceptable to, and approved by, FORA Construction Manager.

Restrictions on Interrupting utilities or operations:

1. The Contractor must maintain all utilities affected by the construction of this project in an operable and functioning condition (including data, voice, video and irrigation systems) to all buildings, facilities, and services at the Project Site at no additional cost to FORA.
2. If any utility affecting any occupied facility is interrupted, the Contractor must provide a temporary connection to the affected utility / facility / area within the noted time frame with due diligence, at no additional cost to FORA. If the Contractor does not perform repairs with due diligence within the time frames noted below, the FORA shall enforce the terms and conditions of the Contract Agreement for Contractor's failure to perform work in a timely manner.

Fire Alarm System.....	Within 4 hours of occurrence
Security Alarm System.....	Within 4 hours of occurrence
Radio Communication or 911 System ...	Within 4 hours of occurrence
Telephone / Data Communications System, including payphones, fiber backbone, copper, etc.).....	Within 4 hours of occurrence
Energy Management Control System....	Within 4 hours of occurrence
Exterior Lighting / Street Lighting.....	Within 4 hours of occurrence
Building Power	Within 4 hours of occurrence
Potable Water.....	Within 6 hours of occurrence, depending on impact of loss of water
Gas	Within 4 hours of occurrence
Sewer	Within 24 hours of occurrence
Storm Drain.....	Within 48 hours of occurrence
Irrigation, including reclaimed water	Within 72 hours of occurrence - provide alternate methods of irrigation if needed during outages to prevent damage to landscape

1.06 NOISE AND VIBRATION RESTRICTIONS

- C. Noise Restrictions: Minimize noise from construction activities. Limit loud construction activities to times when classes are not in session in adjacent facilities.
- D. Vibration Restrictions: Do not perform activities that cause vibrations in adjacent occupied spaces, including spaces above and below location where Work is performed.

1.07 FORA'S USE OF SITE AND PREMISES

- A. FORA Use of Site and Premises: FORA reserves the right to occupy and to place and install equipment in completed or partially completed areas of buildings and site. Such placing of equipment and partial occupancy shall not constitute acceptance of the total Work.

PART 2 – PRODUCTS (NOT USED)

PART 3 – EXECUTION (NOT USED)

END OF SECTION 01 14 00

S201-ITB1, Volume 2 - SECTION 01 15 10 – CONSTRUCTION AND DEMOLITION MATERIALS RECYCLING REQUIREMENTS

PART 1 GENERAL

1.01 SUMMARY

- A. Section includes: Requirements and procedures for ensuring optimal diversion of demolition waste materials generated by the Work from landfill disposal within the limits of the Construction Schedule and Contract Sum.
 - 1. FORA has a goal of participating in global sustainability. Contractor will create a non-hazardous material Construction Waste and Recycling Plan to maximize waste recycling.
 - 2. Requirements for submittal of Contractor's Construction Waste and Recycling Plan prior to the commencement of the Work.
 - 3. Contractor's quantitative reports for construction waste materials as a condition of approval of the third progress payment.

1.02 DEFINITIONS

- A. Class III Landfill: A landfill that accepts non-hazardous resources such as household, commercial, and industrial waste, resulting from construction, remodeling, repair, and demolition operations. A Class III landfill must have a solid waste facilities permit from the California Integrated Waste Management Board (CIWMB).
- B. Demolition Debris: Building materials and solid waste resulting from cleanup, or demolition operations that are not hazardous as defined in California Code of Regulations, Title 22, Section 66261.3 et seq. This term includes, but is not limited to, asphalt concrete, Portland cement concrete, brick, lumber, gypsum wallboard, cardboard and other associated packaging, roofing material, ceramic tile, carpeting, plastic pipe, and steel. The debris may be commingled with rock, soil, tree stumps, and other vegetative matter resulting from land clearing and landscaping for construction or land development projects.
- C. Construction and Demolition (C&D) Recycling Center. A facility that receives only C&D material that has been separated for reuse prior to receipt, in which the residual (disposed) amount of waste in the material is less than 10% of the amount separated for reuse by weight.
- D. Disposal. Final deposition of construction and demolition or inert debris into land, including stockpiling onto land of construction and demolition debris that has not been sorted for further processing or resale, if such stockpiling is for a period of time greater than 30 days; and construction and demolition debris that has been sorted for further processing or resale, if such stockpiling is for a period of time greater than one year, or stockpiling onto land of inert debris that is for a period of time greater than one year.
- E. Inert Disposal Facility or Inert Waste Landfill: A disposal facility that accepts only inert waste such as soil and rock, fully cured asphalt paving, uncontaminated concrete (including fiberglass or steel reinforcing rods embedded in the concrete), brick, glass, and ceramics, for land disposal.

- F. Mixed Debris: Loads that include commingled recyclable and non-recyclable materials generated at the construction site.
- G. Mixed Debris Recycling Facility: A processing facility that accepts loads of commingled construction and demolition debris for the purpose of recovering re-usable and recyclable materials and disposing the non-recyclable residual materials.
- H. Recycling: The process of sorting, cleansing, treating and reconstituting materials for the purpose of using the altered form in the manufacture of a new product. Recycling does not include burning, incinerating or thermally destroying solid waste.
- I. Reuse. The use, in the same or similar form as it was produced, of a material which might otherwise be discarded.
- J. Separated for Reuse. Materials, including commingled recyclables, that have been separated or kept separate from the solid waste stream for the purpose of additional sorting or processing those materials for reuse or recycling in order to return them to the economic mainstream in the form of raw material for new, reused, or reconstituted products which meet the quality standards necessary to be used in the marketplace, and includes materials that have been "source separated."
- K. Solid Waste: All putrescible and nonputrescible solid, semisolid, and liquid wastes, including garbage, trash, refuse, paper, rubbish, ashes, industrial wastes, demolition and construction wastes, abandoned vehicles and parts thereof, discarded home and industrial appliances, dewatered, treated, or chemically fixed sewage sludge which is not hazardous waste, manure, vegetable or animal solid and semisolid wastes, and other discarded solid and semisolid wastes. "Solid waste" does not include hazardous waste, radioactive waste, or medical waste as defined or regulated by State law.
- L. Source-Separated: Materials, including commingled recyclables, that have been separated or kept separate from the solid waste stream at the point of generation for the purpose of additional sorting or processing of those materials for reuse or recycling in order to return them to the economic mainstream in the form of raw materials for new, reused, or reconstituted products which meet the quality standards necessary to be used in the marketplace.
- M. Waste Hauler: A company that possesses a valid permit from the local waste management authority to collect and transport solid wastes from individuals or businesses for the purpose of recycling or disposal in the locality.

1.03 SUBMITTALS

- A. Contractor's Construction Waste and Recycling Plan
 1. Review Contract Documents and estimate the types and quantities of materials under the Work that are anticipated to be feasible for on-site processing, source separation for re-use or recycling. Indicate the procedures that will be implemented in this program to effect jobsite source separation, such as, identifying a convenient location where dumpsters would be located, putting signage to identify materials to be placed in dumpsters, etc.
 2. Prior to commencing the Work, submit Contractor's Construction Waste and Recycling Plan. Submit in format provided (Section 01151A). The Plan must include, but is not limited to the following:

- a. Contractor's name and project identification information;
 - b. Procedures to be used;
 - c. Materials to be re-used and recycled;
 - d. Estimated quantities of materials;
 - e. Names and locations of re-use and recycling facilities/sites;
 - f. Tonnage calculations that demonstrate how much material the Contractor will re-use and recycle, by weight, of the non-hazardous waste materials generated in the Work.
3. Contractor's Construction Waste and Recycling Plan must be approved by FORA Construction Manager prior to the start of Work.
 4. Contractor's Construction Waste and Recycling Plan will not otherwise relieve the Contractor of responsibility for adequate and continuing control of pollutants and other environmental protection measures.
- B. Contractor's Reuse, Recycling, and Disposal Report

Submit Contractor's Reuse, Recycling, and Disposal Report on the form provided (Section 01151B) with each application for progress payment. Failure to submit the form and its supporting documentation will render the application for progress payment incomplete and delay progress payments. If applicable, include manifests, weight tickets, receipts, and invoices specifically identifying the Project for re-used and recycled materials:

1. Reuse of building materials or salvage items on site (i.e. crushed base).
2. Salvaging building materials or salvage items at an off-site salvage or reuse center (i.e. lighting, fixtures).
3. Recycling source separated materials on site (i.e. crushing asphalt/ concrete for base course.)
4. Recycling source separated material at an off-site recycling center (i.e. scrap metal or green materials).
5. Use of material as Alternative Daily Cover (ADC) at landfills.
6. Delivery of soils or mixed inerts to an inert landfill for disposal (inert fill).
7. Disposal at a landfill or transfer station (where no recycling takes place).
8. Other (describe).

Contractor's Reuse, Recycling, and Disposal Report must quantify all materials generated in the Work, disposed in [Class III] landfills, or diverted from disposal through recycling. Indicate zero (0) if there is no quantity to report for a type of material.

As indicated on the form:

1. Report disposal or recycling either in tons: if scales are available at disposal or recycling facility, report in tons; otherwise, convert cubic yards to tons using acceptable conversion factors.
2. Indicate locations to which materials are delivered for reuse, salvage, recycling, accepted as daily cover, inert backfill, or disposal in landfills or transfer stations.

3. Provide legible copies of weigh tickets, receipts, or invoices that specifically identify the project generating the material. Said documents must be from recyclers and/or disposal site operators that can legally accept the materials for the purpose of re-use, recycling, or disposal.

Indicate project title, project number, progress payment number, name of the company completing the Contractor's Report and compiling backup documentation, the printed name, signature, and daytime phone number of the person completing the form, the beginning and ending dates of the period covered on the Contractor's Report, and the date that the Contractor's Report is completed.

PART 2 PRODUCTS (NOT USED)

PART 3 EXECUTION

3.01 SALVAGE, RE-USE, RECYCLING AND PROCEDURES

- A. Identify re-use, salvage, and recycling facilities.
- B. Develop and implement procedures to re-use, salvage, and recycle new construction and excavation materials, based on the Contract Documents, the Contractor's Construction Waste and Recycling Plan, estimated quantities of available materials, and availability of recycling facilities. Procedures may include on-site recycling, source separated recycling, and/or mixed debris recycling efforts.
 1. Identify materials that are feasible for salvage, determine requirements for site storage, and transportation of materials to a salvage facility.
 2. Source separate new construction, excavation and demolition materials including, but not limited to the following types:
 - a. Asphalt.
 - b. Concrete, concrete block, slump stone (decorative concrete block), and rocks.
 - c. Drywall.
 - d. Green materials (i.e. tree trimmings and land clearing debris).
 - e. Metal (ferrous and non-ferrous).
 - f. Miscellaneous Construction Debris.
 - g. Paper or cardboard.
 - h. Red Clay Brick.
 - i. Reuse or Salvage Materials
 - j. Soils.
 - k. Wire and Cable.
 - l. Wood.
 - m. Other (describe)

3. Miscellaneous Construction Debris: Develop and implement a program to transport loads of mixed (commingled) new construction materials that cannot be feasibly source separated to a mixed materials recycling facility.

3.02 DISPOSAL OPERATIONS AND WASTE HAULING

- A. Legally transport and dispose of materials that cannot be delivered to a source separated or mixed recycling facility to a transfer station or disposal facility that can legally accept the materials for the purpose of disposal.
- B. Use a permitted waste hauler or Contractor's trucking services and personnel.
- C. Become familiar with the conditions for acceptance of new construction, excavation and demolition materials at recycling facilities, prior to delivering materials.
- D. Deliver to facilities that can legally accept new construction, excavation and demolition materials for purpose of re-use, recycling, composting, or disposal.
- E. Do not burn, bury or otherwise dispose of waste on the project job-site.

3.03 RE-USE AND DONATION OPTIONS

- A. Implement a re-use program to the greatest extent feasible. Options may include:
 1. California Materials Exchange (CAL-MAX) Program is sponsored by the California Integrated Waste Management Board. CAL-MAX is a free service provided by the California Integrated Waste Management Board, designed to help businesses find markets for materials that traditionally would be discarded. The premise of the CAL-MAX Program is that material discarded by one business may be a resource for another business. To obtain a current Materials Listings Catalog, call CAL-MAX/California Integrated Waste Management Board at (916) 255-2369 or send a FAX to (916) 255-2200. The CALMAX Catalog is available through the Internet Site at <http://www.ciwmb/ca.gov/calmax>.

3.04 REVENUE

- A. Revenues or other savings obtained from recycled, re-used, or salvaged materials shall accrue to Contractor unless otherwise noted in the Contract Documents.

END OF SECTION 01 15 10

**SECTION 01151A
CONTRACTOR'S CONSTRUCTION WASTE AND RECYCLING PLAN**

(Submit After Award of Contract and Prior to Start of Work)

Project Title:		
Contract or Work Order No.:		
Contractor's Name:		
Street Address:		
City:	State:	Zip:
Phone: ()	Fax: ()	
E-Mail Address:		
Prepared by: (Print Name)		

Date Submitted:		
Project Period:	From:	TO:

Reuse, Recycling or Disposal Processes To Be Used

Describe the types of recycling processes or disposal activities that will be used for material generated in the project. Indicate the type of process or activity by number, types of materials, and estimated quantities that will be recycled or disposed in the sections below:

- 01 - Reuse of building materials or salvage items on site (i.e. crushed base or red clay brick)
- 02 - Salvaging building materials or salvage items at an off site salvage or re-use center (i.e. lighting, fixtures)
- 03 - Recycling source separated materials on site (i.e. crushing asphalt/concrete for reuse or grinding for mulch)
- 04 - Recycling source separated materials at an off site recycling center (i.e. scrap metal or green mats)
- 05 - Recycling commingled loads of C&D mats at an off site mixed debris recycling center or transfer station
- 06 - Recycling material as Alternative Daily Cover at landfills
- 07 - Delivery of soils or mixed inerts to an inert landfill for disposal (inert fill).
- 08 - Disposal at a landfill or transfer station.
- 09 - Other (please describe) _____

Types of Material To Be Generated

Use these codes to indicate the types of material that will be generated on the project

- | | | | | |
|---|---------------------|------------------|--------------------------|----------------|
| A = Asphalt | C = Concrete | M = Metals | I = Mixed Inert | G = Green Mats |
| D = Drywall | P/C=Paper/Cardboard | W/C = Wire/Cable | S= Soils (Non Hazardous) | |
| M/C = Miscellaneous Construction Debris | R = Reuse/Salvage | W = Wood | O = Other (describe) | |

Facilities Used: Provide Name of Facility and Location (City)

Total Truck Loads: Provide Number of Trucks Hauled from Site During Reporting Period

Total Quantities: If scales are available at sites, report in tons. If not, quantify by cubic yards. For salvage/reuse items, quantify by estimated weight (or units).

SECTION I - RE-USED/RECYCLED MATERIALS

Include all recycling activities for source separated or mixed material recycling centers where recycling will occur.

Type of Material	Type of Activity	Facility to be Used, Location	Total Truck Loads	Total Quantities		
				Tons	Cubic YD	Other Wt.
(ex.) M	04	ABC Metals, Los Angeles	24	355		
a. Total Diversion			-	-	-	-

Continued

SECTION II - DISPOSED MATERIALS						
<i>Include all disposal activities for landfills, transfer stations, or inert landfills where no recycling will occur.</i>						
Type of Material	Type of Activity	Facility to be Used, Location	Total Truck Loads	Total Quantities		
				Tons	Cubic YD	Other Wt.
(ex.) D	08	DEF Landfill, Los Angeles	2	35		
b. Total Disposal				-	-	-

SECTION III - TOTAL MATERIALS GENERATED						
<i>This section calculates the total materials to be generated during the project period (Reuse/Recycle + Disposal = Generation)</i>						
				Tons	Cubic YD	Other Wt.
a. Total Reused/Recycled				-	-	-
b. Total Disposed				-	-	-
c. Total Generated				-	-	-

SECTION IV - CONTRACTOR'S LANDFILL DIVERSION RATE CALCULATION						
<i>Add totals from Section I + Section II</i>						
		Tons	Cubic Yards	Other Wt.		
a. Materials Re-Used and Recycled		-				
b. Materials Disposed		-				
c. Total Materials Generated (a. + b. = c.)		-	-	-		
d. Landfill Diversion Rate (Tons Only)*		#DIV/0!				

* Use tons only to calculate recycling percentages: $Tons\ Reused/Recycled/Tons\ Generated = \% \text{ Recycled}$

Contractor's Comments (Provide any additional information pertinent to planned reuse, recycling, or disposal activities):

Notes:

- Section 01151A is a Division 01 General Requirement under CSI MasterFormat 1998 Edition. For CSI MasterFormat 2004 Edition, this Section may be renumbered as follows:
Under Division 00, Procurement and Contracting Requirements, Project Forms 00 60 00
Use: Section 00 62 22 Construction Waste Diversion Plan
- Suggested Conversion Factors: From Cubic Yards to Tons (Use when scales are not available)
Asphalt: .61 (ex. 1000 CY Asphalt = 610 tons. Applies to broken chunks of asphalt)
Concrete: .93 (ex. 1000 CY Concrete = 930 tons. Applies to broken chunks of concrete)
Ferrous Metals: .22 (ex. 1000 CY Ferrous Metal = 220 tons)
Non-Ferrous Metals: .10 (ex. 1000 CY Non-Ferrous Metals = 100 tons)
Drywall Scrap: .20
Wood Scrap: .16

**SECTION 01151B
CONTRACTOR'S REUSE, RECYCLING, AND DISPOSAL REPORT**

(Submit With Each Progress Payment)

Project Title:		
Contract or Work Order No.:		
Contractor's Name:		
Street Address:		
City:	State:	Zip:
Phone: ()	Fax: ()	
E-Mail Address:		
Prepared by: (Print Name)		

Date Submitted:		
Period Covered:	From:	To:

Reuse, Recycling or Disposal Processes Used

Describe the types of recycling processes or disposal activities used for material generated in the project. Indicate the type of process or activity by number, types of materials, and quantities that were recycled or disposed in the sections below:

01 - Reuse of building materials or salvage items on site (i.e. crushed base or red clay brick)
 02 - Salvaging building materials or salvage items at an off site salvage or re-use center (i.e. lighting, fixtures)
 03 - Recycling source separated materials on site (i.e. crushing asphalt/concrete for reuse or grinding for mulch)
 04 - Recycling source separated materials at an off site recycling center (i.e. scrap metal or green mats)
 05 - Recycling commingled loads of C&D mats at an off site mixed debris recycling center or transfer station
 06 - Recycling material as Alternative Daily Cover at landfills
 07 - Delivery of soils or mixed inerts to an inert landfill for disposal (inert fill).
 08 - Disposal at a landfill or transfer station.
 09 - Other (please describe) _____

Types of Material Generated

Use these codes to indicate the types of material that were generated on the project

A = Asphalt C = Concrete M = Metals I = Mixed Inert G = Green Mats
 D = Drywall P/C=Paper/Cardboard W/C = Wire/Cable S= Soils (Non Hazardous)
 M/C = Miscellaneous Construction Debris R = Reuse/Salvage W = Wood O = Other (describe)

Facilities Used: Provide Name of Facility and Location (City)

Total Truck Loads: Provide Number of Trucks Hauled from Site During Reporting Period

Total Quantities: If scales are available at sites, report in tons. If not, quantify by cubic yards. For salvage/reuse items, quantify by estimated weight (or units).

SECTION I - RE-USED/RECYCLED MATERIALS

Include all recycling activities for source separated or mixed material recycling centers where recycling occurred.

Type of Material	Type of Activity	Facilities Used, Location	Total Truck Loads	Total Quantities		
				Tons	Cubic YD	Other Wt.
(ex.) M	04	ABC Metals, Los Angeles	24	355		
a. Total Diversion			-	-	-	-

Continued

SECTION II - DISPOSED MATERIALS						
<i>Include all disposal activities for landfills, transfer stations, or inert landfills where no recycling occurred.</i>						
Type of Material	Type of Activity	Facilities Used, Location	Total Truck Loads	Total Quantities		
				Tons	Cubic YD	Other Wt.
(ex.) D	08	DEF Landfill, Los Angeles	2	35		
b. Total Disposal				-	-	-

SECTION III - TOTAL MATERIALS GENERATED						
<i>This section calculates the total materials generated during the project period (Reuse/Recycle + Disposal = Generation)</i>						
				Tons	Cubic YD	Other Wt.
a. Total Reused/Recycled				-	-	-
b. Total Disposed				-	-	-
c. Total Generated				-	-	-

SECTION IV - CONTRACTOR'S LANDFILL DIVERSION RATE CALCULATION						
<i>Add totals from Section I + Section II</i>						
			Tons	Cubic Yards	Other Wt.	
a. Materials Re-Used and Recycled			-			
b. Materials Disposed			-			
c. Total Materials Generated (a. + b. = c.)			-	-	-	
d. Landfill Diversion Rate (Tons Only)*			#DIV/0!			

* Use tons only to calculate recycling percentages: $Tons\ Reused/Recycled/Tons\ Generated = \% \text{ Recycled}$

Contractor's Comments (*Provide any additional information pertinent to planned reuse, recycling, or disposal activities*):

Notes:

- Section 01151A is a Division 01 General Requirement under CSI MasterFormat 1998 Edition. For CSI MasterFormat 2004 Edition, this Section may be renumbered as follows:
 Under Division 00, Procurement and Contracting Requirements, Project Forms 00 60 00
 Use: Section 00 62 22 Construction Waste Diversion Plan
- Suggested Conversion Factors: From Cubic Yards to Tons (Use when scales are not available)
 Asphalt: .61 (ex. 1000 CY Asphalt = 610 tons. Applies to broken chunks of asphalt)
 Concrete: .93 (ex. 1000 CY Concrete = 930 tons. Applies to broken chunks of concrete)
 Ferrous Metals: .22 (ex. 1000 CY Ferrous Metal = 220 tons)
 Non-Ferrous Metals: .10 (ex. 1000 CY Non-Ferrous Metals = 100 tons)
 Drywall Scrap: .20
 Wood Scrap: .16

S201-ITB1, Volume 2 - SECTION 01 31 13.1 – REQUESTS FOR INTERPRETATION (RFI)

PART 1 – GENERAL

1.01 RELATED DOCUMENTS

- A. Construction Drawings, Technical Specifications, Addenda, and Contract Agreement, including any Addenda, including other Division 1 Specification Sections, apply to this Section.

1.02 SECTION INCLUDES

- A. Procedures for submitting requests for interpretation (RFI).
- B. Limitations on use of RFI to obtain interpretation and clarification.

1.03 DEFINITIONS

- A. Request for Interpretation: A document submitted by the Contractor requesting clarification of a portion of the Contract Documents, hereinafter referred to as an RFI.

1.04 CONTRACTOR'S REQUESTS FOR INTERPRETATION (RFIs)

- B. Contractor's Requests for Interpretation (RFIs): Should Contractor be unable to determine from the Contract Documents the exact material, process, or system to be installed; or when the elements of construction are required to occupy the same space (interference); or when an item of Work is described differently at more than one place in the Contract Documents; the Contractor shall request that the FORA Construction Manager make an interpretation of the requirements of the Contract Documents to resolve such matters. Contractor shall comply with procedures specified herein to make Requests for Interpretation (RFIs).
- C. Submission of RFIs: RFIs shall be prepared and submitted on a form provided by the FORA Construction Manager.
 - 1. Forms shall be completely filled in, and if prepared by hand, shall be fully legible after copying by xerographic process.
 - 2. Each RFI shall be given a discrete, consecutive number.
 - 3. Each page of the RFI and each attachments to the RFI shall bear the FORA's project name, project number, date, RFI number and a descriptive title.
 - 4. Contractor shall sign all RFIs attesting to good faith effort to determine from the Contract Documents the information requested for interpretation. Frivolous RFIs shall be subject to reimbursement from Contractor to FORA Construction Manager for fees charged by FORA's consultants and other design professionals engaged by the FORA.
- D. Subcontractor-Initiated and Supplier-Initiated RFIs: RFIs from subcontractors and material suppliers shall be submitted through, be reviewed by and be attached to an RFI prepared, signed and submitted by Contractor. RFIs submitted directly by subcontractors or material suppliers will be returned unanswered to the Contractor.

1. Contractor shall review all subcontractor- and supplier-initiated RFIs and take actions to resolve issues of coordination, sequencing and layout of the Work.
 2. RFIs submitted to request clarification of issues related to means, methods, techniques and sequences of construction or for establishing trade jurisdictions and scopes of subcontracts will be returned without interpretation. Such issues are solely the Contractor's responsibility.
 3. Contractor shall be responsible for delays resulting from the necessity to resubmit an RFI due to insufficient or incorrect information presented in the RFI.
- E. Requested Information: Contractor shall carefully study the Contract Documents, in particular, Article 2 of the Contract Agreement, to ensure that information sufficient for interpretation of requirements of the Contract Documents is not included. RFIs that request interpretation of requirements clearly indicated in the Contract Documents will be returned without interpretation.
1. In all cases in which RFIs are issued to request clarification of issues related to means, methods, techniques and sequences of construction, for example, pipe and duct routing, clearances, specific locations of Work shown diagrammatically, apparent interferences and similar items, the Contractor shall furnish all information required for the FORA Construction Manager to analyze and/or understand the circumstances causing the RFI and prepare a clarification or direction as to how the Contractor shall proceed.
 2. If information included with this type RFI by the Contractor is insufficient, the RFI will be returned unanswered.
- F. Unacceptable Uses for RFIs: RFIs shall not be used to request the following:
1. Approval of submittals (use procedure specified in Section 01 33 00 - Submittals Procedures)
 2. Approval of substitutions (refer to Section 01 63 00 - Product Substitution Procedures)
 3. Changes that entail change in Contract Time and Contract Sum (comply with provisions of the Article 5 of the Contract Agreement, as discussed in detail during pre-construction meeting).
 4. Different methods of performing Work than those indicated in the Contract Drawings and Specifications (comply with provisions of the Article 5 of the Contract Agreement).
- G. Disputed Requirements: In the event the Contractor believes that a clarification by the FORA Construction Manager results in additional cost or time, Contractor shall comply with Article 22 of the Contract Agreement.
- H. RFI Log: Contractor shall prepare and maintain a log of RFIs, and at any time requested by the FORA Construction Manager, the Contractor shall furnish copies of the log showing all outstanding RFIs.
- I. Review Time: FORA Construction Manager will return RFIs to Contractor within seven calendar days of receipt. RFIs received after 12:00 noon shall be considered received on the next regular working day for the purpose of establishing the start of the seven-calendar day response period.

PART 2 – PRODUCTS (NOT USED)

PART 3 – EXECUTION (NOT USED)

END OF SECTION 01 31 13.1

S201-ITB1, Volume 2 - SECTION 01 31 20 – PROJECT MEETINGS

PART 1 - GENERAL

1.01 RELATED DOCUMENTS

- A. Construction Drawings, Technical Specifications, Addenda, and Contact Agreement, including any Addenda, including other Division 1 Specification Sections, apply to this Section.

1.02 REQUIREMENTS INCLUDED

- A. Preconstruction meeting.
- B. Construction progress meetings.

1.03 RELATED REQUIREMENTS

- A. Section 01 45 00 - Quality Control: General requirements for construction quality, to be reviewed at construction progress meetings.

1.04 RECONSTRUCTION MEETING

- B. Preconstruction Meeting: FORA Construction Manager will administer a preconstruction meeting immediately prior to Contractor mobilization onto the project site.
 - 1. Contractor and major subcontractors, as appropriate, shall attend.
- C. Schedule: Schedule preconstruction meeting within five days of construction start date established in the Notice to Proceed.
- D. Location: Preconstruction meeting will be held at a location as directed by the FORA Construction Manager.
- D. Agenda: Preconstruction meeting shall cover the following topics as a minimum.
 - 1. Special Project Procedures: Site access restrictions, if any, and requirements to avoid disruption of operations at adjoining facilities. Present FORA's requirements for use of Project Site.
 - 2. Designation of Key Personnel: Contractor shall designate key personnel and provide a name and address list that includes the following.
 - a. Contractor: Project Manager and Superintendent.
 - b. Major subcontractors: Principal/Project Manager and Superintendent.
 - c. Major materials suppliers: Contact person.
 - 3. Subcontractors List: Distribute and discuss list of subcontractors and suppliers.
 - 4. Coordination: Review requirements for Contractor's coordination of Work. Review sequence and schedule for work being performed for University under separate contracts. Discuss coordination of construction to minimize impacts on nearby businesses and construction activities.

5. Project Communication Procedures: Review requirements and administrative requirements for written and oral communications.
6. Construction Schedule: Distribute and discuss initial construction schedule and critical work sequencing of major elements of Work, including coordination of other FORA contractors and work under separate contracts by serving utility agencies and companies.
7. Site Security: Review requirements for Contractor to develop and implement site security.
8. Safety Program: Review requirements for Contractor to develop and implement safety program in compliance with Contract Agreement.
9. Site Access by FORA and FORA Construction Manager Representative: Review requirements and administrative procedures Contractor may wish to institute for identification and reporting purposes.
10. Permits and Fees: Review Contract requirements and review schedule and process for obtaining permits and paying fees.
11. Project Layout: Review requirements for laying out of Work, including surveying requirements.
12. Construction Facilities: Designate storage and staging areas, construction office areas and parking areas and review site access requirements.
13. Temporary Utilities: Requirements for establishing and paying for temporary water, power, lighting and other utility services during construction, including metering and allowances. Refer to Section 01 51 00 - Temporary Utilities.
14. Construction Progress Schedules: Review requirements for preparation and updating of construction progress and submittals schedules.
15. Payment Procedures: Review requirements for preparation and submission of applications for progress payments and for final payment.
16. Change Procedures: Review requirements and administrative procedures for Change Orders, Field Instructions and Contractor's Requests for Interpretation (RFI).
17. Testing and Inspection: Review tests and inspections to be performed by the following.
 - a. Independent testing and inspection agency.
 - b. Serving utilities and public agencies.
 - c. Authorities having jurisdiction.
18. Contract Closeout: Review requirements specified in Section 01 77 00 - Contract Closeout Procedures, including procedures for filing of Notice of Completion, final payment and submittals.

1.05 CONSTRUCTION PROGRESS MEETINGS

- A. Construction Progress Meetings: Meetings will be held to review progress and quality of construction. The essence of the discussion of each meeting shall be entered into the written record (minutes) of the meeting by the Contractor.
- B. Schedule: Construction progress meetings shall be weekly throughout progress of the Work.

- C. Administration: Contractor shall make physical arrangements for meetings. Contractor shall prepare agenda with copies for participants, preside at meetings, record minutes and distribute copies within two working days to FORA and FORA Construction Manager, and participants and those affected by decisions made at meetings. Each discussion item at construction progress meetings shall be numerically identified and carried through subsequent meeting minutes until resolved.
- D. Attendance: Contractor's project manager and jobsite superintendent shall attend each meeting. Contractor's subcontractors and suppliers may attend as appropriate to subject under discussion. FORA and/or FORA Construction Manager will attend each meeting.
- E. Suggested Agenda for Each Construction Progress Meeting:
 - 1. Meeting Minutes: Review and correct, if necessary, minutes of previous meeting.
 - a. Unless published minutes are challenged in writing prior to the next regularly scheduled progress meeting, they will be accepted as properly stating the activities and decisions of the meeting.
 - b. Persons challenging published minutes shall reproduce and distribute copies of the challenge to all indicated recipients of the particular set of minutes.
 - c. Challenge to minutes shall be settled as priority portions of "old business" at the next regularly scheduled meeting.
 - 2. Progress of the Work: Since last meeting and proposed progress.
 - a. Identify potential problems which might impede progress.
 - b. Develop corrective measures and procedures, including but not necessarily limited to additional man loading to regain planned schedule.
 - c. Review three-week "look ahead" construction schedule, including identification of conflicts and delays.
 - 3. RFI Status: Review status of Requests for Interpretation (RFI) status.
 - 4. Contract Modifications: Pending Change Orders and Field Orders. Review status of proposed substitutions.
 - 5. Old Business: Active discussion topics carried over from previous meetings.
 - 6. New Business: New topics of discussion affecting construction progress and quality.
 - 7. Quality Control: Review maintenance of quality standards and identification of non-conforming Work, including proposed remedial measures to be taken by Contractor.
 - 8. Environmental and Safety Issues.
 - 9. Other items affecting progress and quality of the Work.
- F. Meeting Time and Location: As mutually agreed by the Contractor, and the FORA Construction Manager at on-site location.
- G. Special Meetings: As necessary, the Contractor, or the FORA Construction Manager may convene special meetings to discuss specific construction issues in detail and to plan specific activities.

1.06 CONTRACT COMPLETION MEETING

- A. Contract Closeout Meeting: As specified in Section 01 77 00 - Contract Closeout Procedures.

PART 2 – PRODUCTS (NOT USED)

PART 3 – EXECUTION (NOT USED)

END OF SECTION 01 31 20

S201-ITB2, Volume 2 - SECTION 01 33 00 – SUBMITTALS PROCEDURES

PART 1 - GENERAL

1.01 RELATED DOCUMENTS

- A. Construction Drawings, Technical Specifications, Addenda, and Contact Agreement, including any Addenda, including other Division 1 Specification Sections, apply to this Section.

1.02 SECTION INCLUDES

- A. Administrative requirements for shop drawings, product data and samples submittals.
- B. Administrative requirements for submittals reporting results of tests and inspections, during field Work.
- C. Contractor's review of submittals.
- D. Shop drawing submittals.
- E. Reports of results of tests and inspections.

1.03 RELATED SECTIONS

- A. Construction Progress Schedules: Submittals Schedule.
- B. Section 01 45 00 - Quality Control
- C. Section 01 77 00 - Contract Closeout Procedures

1.04 DEFINITIONS

- A. Shop Drawings, Product Data and Samples: Instruments prepared and submitted by Contractor, for Contractor's benefit, to communicate to FORA Construction Manager the Contractor's understanding of the design intent, for review and comment by Architect on the conformance of the submitted information to the general intent of the design. Shop drawings, product data and samples are not Contract Documents.
- B. Shop Drawings: Drawings, diagrams, schedules and illustrations, with related notes, specially prepared for the Work of the Contract, to illustrate a portion of the Work.
- C. Product Data: Standard published information ("catalog cuts") and specially prepared data for the Work of the Contract, including standard illustrations, schedules, brochures, diagrams, performance charts, instructions and other information to illustrate a portion of the Work.
- D. Other Submittals: Technical data, test reports, calculations, surveys, certifications, special warranties and guarantees, operation and maintenance data, extra stock and other submitted information and products shall also be not be considered to Contract Documents but shall be information from Contractor to Architect to illustrate a portion of the Work for confirmation of understanding of design intent.

1.05 ADMINISTRATIVE REQUIREMENTS

- A. Administrative Requirements for Submittals: Submittals shall be made in accordance with requirements specified in the Technical Specifications, as represented on the drawings. See

also **Article 5 of the Contract General Conditions** for additional requirements especially those regarding requests for alternatives or equals and for substitutions.

- B. Contractor Coordination of Submittals: Coordinate preparation and processing of submittals with performance of construction activities. Transmit each submittal sufficiently in advance of performance of related construction activities to avoid delay.
 - 1. Coordinate each submittal with fabrication, purchasing, testing, delivery, other submittals and related activities that require sequential activity.
 - 2. Coordinate transmittal of different types of submittals for related elements of the Work so processing will not be delayed by the need to review submittals concurrently for coordination. The FORA Construction Manager will return without action submittals requiring coordination with other submittals until related submittals are coordinated.
- C. Submittals List: Contractor shall prepare and submit a Submittals List for review and approval by the FORA Construction Manager. Submittals List shall identify all specified submittals to be made and shall serve as checklist for submittals.
 - 1. Format shall be suitable for Project and shall be subject to acceptance by FORA Construction Manager. Comply with directions by FORA Construction Manager for scope and format of Submittals List.
 - 2. Submittals list shall include the following submittal types and headings:
 - SD = Shop Drawings are required
 - PD = Product Data required
 - SA = Samples required
 - CO = Color samples required
 - SS = Site Sample installations are required
 - LM = List of Materials
 - RD = Record Drawings required
 - CE = Certificates are required
 - PR = Manufacturer's instructions or specifications required
 - OM = Operation and Maintenance manuals are required
 - Q = Maintenance materials/equipment are required
 - WA = Warranties and/or guarantees are required
 - LR = Laboratory Reports are required
 - FT = Factory Test reports are required
 - ST = Site Test reports required
 - RP = Submittal to the Architect for record purposes only and not for review or approval
 - O = Other submittal requirements as specified in Section
 - 3. Sample Table:

1.06 Section	1.07 SD	1.08 PD	1.09 SA	1.010 CO	1.011 SS	1.012 LM	1.013 RD	1.014 CE	1.015 P
--------------	---------	---------	---------	----------	----------	----------	----------	----------	---------

1.024 05120	1.025 x	1.026	1.027	1.028	1.029	1.030 x	1.031	1.032	1.033
1.042 09250	1.043	1.044 x	1.045	1.046	1.047 x	1.048 x	1.049	1.050 x	1.051
1.060 10810	1.061	1.062 x	1.063 x	1.064	1.065	1.066	1.067	1.068	1.069

D. Transmission of Submittals: Package each submittal appropriately for shipping and handling. Transmit all submittals from Contractor to FORA Construction Manager, unless otherwise directed, using a transmittal form. Submittals received from sources other than the Contractor will be returned without action. Include all information specified below for identification of submittal and for monitoring of review process.

E. Timing of Submittals: Make submittals sufficiently in advance of construction activities to allow shipping, handling and review by the FORA Construction Manager. Allow sufficient review time so that installation will not be delayed as a result of the time required to process submittals, including time for resubmittals.

1. See Contract General Conditions and Supplementary General Conditions for additional requirements.
2. If an intermediate submittal is necessary, process the same as the initial submittal.
3. No extension of Contract Time will be authorized because of failure to transmit submittals to the Architect sufficiently in advance of the Work to permit processing.

F. Submittals Identification:

1. Provide a space approximately four-inches by five-inches on the label or beside the title block on Shop Drawings to record the Contractor's review and approval markings and the action taken. Include the following information on the label for processing and recording action taken:
 - a. Project name and Trustees project number
 - b. Submission date
 - c. Name and address of Contractor
 - d. Name and address of subcontractor
 - e. Name and address of supplier
 - f. Name of manufacturer
 - g. Number and title of appropriate Specification Section
 - h. Drawing number and detail references, as appropriate.

2. Identify each submittal by Specification Section number followed by a number indicating sequential submittal for that Section. Resubmittals shall use same number as original submittal, followed by a letter indicating sequential resubmittal. For example:

09250-1 First submittal for Section 09250 - Gypsum Board.
09250-2 Second submittal for Section 09250 - Gypsum Board.
09250-2A Resubmittal of second submittal for Section 09250 - Gypsum Board.
09250-2B Second resubmittal of second submittal for Section 09250 Gypsum Board.

3. Place a permanent label or title block on each submittal for identification. Indicate the name of the entity that prepared each submittal on the label or title block.

- G. Grouping of Submittals: Unless otherwise specifically permitted by the FORA Construction Manager, make all submittals in groups containing all associated items. The FORA Construction Manager may reject partial submittals as incomplete or hold them until related submittals are made.
- H. Unsolicited Submittals: Unsolicited submittals may be returned unreviewed.
- I. Record Submittals: When record submittals are specified, submit three copies or sets only. Record submittals will not be reviewed but will be retained for historical and maintenance purposes.

1.7 SUBMITTALS SCHEDULE

- A. Submittals Schedule: As specified in the Construction Progress Schedules.

1.8 CONTRACTOR'S REVIEW OF SUBMITTALS

- A. Contractor's Review of Submittals: Prior to submission to FORA Construction Manager for review, Contractor shall review each submittal for completeness and conformance to specified requirements. Contractor shall stamp each submittal with a review action stamp and sign each copy of submittal. Submittals without stamp and signature will not be reviewed and will be returned. Contractor's submittal action stamp shall certify the following actions by Contractor:
 - 1. Field measurements have been determined and verified.
 - 2. Conformance with requirements of Contract Drawings and Specifications is confirmed.
 - 3. Catalog numbers and similar data are correct.
 - 4. Work being performed by various subcontractors and trades is coordinated.
 - 5. Field construction criteria have been verified, including confirmation that information submitted has been coordinated with the work being performed by others for University and actual site conditions.
 - 6. All deviations from requirements of Drawings and Specifications have been identified and noted.
- B. Changes in Work: Changes in the Work shall not be authorized by submittals review actions. No review action, implicit or explicit, shall be interpreted to authorize changes in the Work. Changes shall only be authorized by separate written direction from the FORA Construction Manager, in accordance with the **Contract General Conditions**.

1.9 REVIEW OF SUBMITTALS BY FORA CONSTRUCTION MANAGER

- A. Review of Submittals by FORA Construction Manager: Submittals shall be a communication aid between Contractor and FORA Construction Manager by which interpretation of Contract Documents requirements may be confirmed in advance of construction.
 - 1. Reviews by FORA Construction Manager and FORA's consultants shall be only for general conformance with the design concept of the Project and general compliance with the information given in the Drawings and Specifications.

2. Except for submittals for record, information or similar purposes, where action and return is required or requested, the FORA Construction Manager will review each submittal, mark to indicate action taken, and return promptly.
- B. Review Action: FORA Construction Manager or FORA's consultants will stamp each submittal with a uniform, self-explanatory action stamp. Stamp will be appropriately marked, as follows, to indicate the action taken:
1. Final Unrestricted Release: Where submittals are marked "Approved," that part of the Work covered by the submittal may proceed provided it complies with requirements of the Contract Documents; final acceptance will depend upon that compliance.
 2. Final-But-Restricted Release: When submittals are marked "Approved as Noted," that part of the Work covered by the submittal may proceed provided it complies with notations or corrections on the submittal and requirements of the Contract Documents; final acceptance will depend on that compliance.
 3. Returned for Re-submittal: When submittal is marked "Not Approved, Revise and Resubmit," do not proceed with that part of the Work covered by the submittal, including purchasing, fabrication, delivery, or other activity. Revise or prepare a new submittal in accordance with the notations; resubmit without delay. Repeat if necessary to obtain a different action mark.
 - a. Do not permit submittals marked "Not Approved, Revise and Resubmit" to be used at the Project site, or elsewhere where Work is in progress.
 - b. Note: Any work performed prior to receiving a fully approved submittal shall be done at the Contractor's risk and shall be subject to being replaced if Contract requirements are not met.
- C. Contract Requirements:
1. Review actions by FORA Construction Manager or FORA's consultants shall not relieve the Contractor from compliance with requirements of the Contract Drawings and Specifications.
 2. No review action, implicit or explicit, shall be interpreted to authorize changes in the Work. Changes shall only be authorized by separate written Change Order or Field Instruction, in accordance with the **Contract General Conditions**.

1.10 PRODUCT DATA SUBMITTALS

- A. Product Data: Catalog cuts, photographs, illustrations, standard details, standard schedules, performance charts, material characteristics, color and pattern charts, test data, roughing-in diagrams and templates, standard wiring diagrams and performance curves and listings by Code authorities and nationally-recognized testing and inspection services. Where product data must be specially prepared because standard printed data is not suitable for use, submit according to requirements for shop drawings, specified below.
- B. Modifications to Standard Product Data: Modify manufacturer's standard catalog data to indicate precise conditions of the Project.
1. Mark each copy to show applicable choices and options. Where printed product data includes information on several products, some of which are not required, mark copies to highlight applicable information.

2. Include the following information:
 - Manufacturer's printed recommendations,
 - Compliance with recognized trade association standards,
 - Compliance with recognized testing agency standards,
 - Application of testing agency labels and seals,
 - Notation of dimensions verified by field measurement,
 - Notation of coordination requirements.
 3. Do not submit product data until compliance with requirements of the Contract Documents has been confirmed.
 4. Proceed with installation only using reviewed copy of product data. Do not permit use of unmarked copies of product data in connection with construction.
- C. Copies: Contractor shall submit one electronic copy of the submittal to the FORA Construction Manager. For shop drawings including samples, submit the electronic copy of the submittal and separately transmit six (6) sample pieces.

1.11 SHOP DRAWINGS SUBMITTALS

- A. Shop Drawings: Drawings, diagrams, schedules and other graphic depictions to illustrate fabrication and installation of a portion of the Work. Shop Drawings shall include fabrication and installation drawings, setting diagrams, schedules, patterns, templates and similar drawings. Include the following information:
1. Identification of products and materials included
 2. Compliance with referenced standards
 3. Notation of coordination requirements
 4. Dimensions
 5. Notation of dimensions established by field measurement.
- B. Coordination: Show all field dimensions and relationships to adjacent or critical features of Work.
- C. Preparation of Shop Drawings: Prepare and submit newly prepared information, drawn to accurate scale. Highlight, encircle, or otherwise indicate deviations from the Contract Documents. Do not reproduce Contract Documents or copy standard information as the basis of Shop Drawings. Standard information prepared without specific reference to the Project is not considered Shop Drawings.
1. Prepare shop drawings on minimum sheet size of 8-1/2 inches by 11-inches. Maximum size shall be 24-inches by 36-inches.
 2. Do not use Shop Drawings without an appropriate final review stamp indicating action taken in connection with construction.
- D. Distribution of Reviewed Shop Drawings: Distribution of reviewed shop drawings will be by FORA Construction Manager. Contractor shall submit one electronic copy of the submittal to the FORA Construction Manager. For shop drawings including samples, submit the electronic copy of the submittal and separately transmit eight (8) sample pieces.

1.12 SAMPLES SUBMITTALS

- A. Samples: Full-size, fully-fabricated samples, cured and finished as specified and physically identical with the material or product proposed. Samples shall include partial sections of manufactured or fabricated components, cuts or containers of materials, color range sets, and swatches showing color, texture and pattern.
1. Mount, display, or package Samples in the manner specified to facilitate review of qualities indicated. Prepare Samples to include the following:
Generic description of the Sample
Sample source
Product name or name of manufacturer
Compliance with recognized standards
Availability and delivery time.
 2. Submit Samples for review of kind, color, pattern, and texture, for a final check of these characteristics with other elements, and for a comparison of these characteristics between the final submittal and the actual component as delivered and installed.
 3. Submit actual samples. Photographic or printed reproductions will not be accepted.
 4. Field samples specified in individual Sections are special types of samples. Field samples shall be full-size examples erected on site to illustrate finishes, coatings, or finish materials and to establish the standard by which the Work will be evaluated.
- B. Preliminary or Selection Submittals: Where samples are for selection of color, pattern, texture or similar characteristics from a range of standard choices, submit full set of choices for the specified material or product.
1. Preliminary submittals will be reviewed and returned with the Architect's mark indicating selection and other action.
- C. Quantity: Except for samples illustrating assembly details, workmanship, fabrication techniques, connections, operation and similar characteristics, submit three sets. One sample will be returned marked with the action taken.
1. Maintain sets of samples, as returned, at the Project site, for quality comparisons throughout the course of construction.
 2. Unless otherwise noted, full-size and complete samples will be returned and may be incorporated into field mock-ups. Samples may be incorporated into the Work (completed construction) only with written approval of the Architect.
 3. Other samples shall be produced and mounted on cardstock in 8-1/2" by 11" format, three-hole punched and suitable for inclusion in product sample binders. Contractor shall provide binders as directed.
 4. Contractor shall prepare and distribute additional samples to subcontractors, manufacturers, fabricators, suppliers, installers, and others as necessary for performance of the Work.
- D. Color Samples: Architect will review and select colors for Project only after all colors are received, so that colors may be properly coordinated.
- E. Review of Field Samples: Review by Architect of field samples will be made for the following products if not otherwise required and if requested by Contractor.

1. Gypsum board textures and finishes.
2. Gypsum plaster textures and finishes.
3. Field-applied paint colors and finishes: Draw-downs and brush-outs.
4. Ceiling panels
5. Sound Soak

1.13 1 MANUFACTURER'S INSTRUCTIONS

- A. Manufacturer's Instructions: Submit manufacturer's instructions for preparation, mixing, assembly, handling, application and installation of products, as applicable and as specified in product Sections of the Specifications.
 1. Include applicable ICBO ES Evaluation Reports. Evaluation Reports shall be current and shall be annotated for applicable products.
 2. Include applicable Material Safety Data Sheets, for Project record only.
 3. Include written recommendations, as applicable, from manufacturer for Project conditions.
- B. Copies: Submit five copies minimum. Distribution will be:
 1. University's Representative: One copy
 2. Architect: One copy
 3. Architect's consultant: One copy
 4. Project Inspector: One copy
 5. Contractor: As necessary, retained by Contractor.
 6. Reviews by Architect and University's Representative: Manufacturer's instructions shall be for information and will not be reviewed by Architect or University's Representative.

1.14 REPORTS OF RESULTS OF INSPECTIONS AND TESTS

- A. Reports of Results of Inspections and Tests: Submit technical data, test reports, calculations, surveys, and certifications based on field tests and inspections by independent inspection and testing agency and by authorities having jurisdiction.
 1. Reports of results of inspections and tests shall not be considered Contract Documents.
 2. Refer to Section 01450 - Quality Control for additional requirements.

1.15 OPERATION AND MAINTENANCE DATA SUBMITTALS

- A. Operation and Maintenance Data Submittals: Refer to requirements specified in Section 01783 - Operation and Maintenance Data. Include operation and maintenance data submittals in Submittals Schedule. Refer to the Construction Progress Schedules.

PART 2 – PRODUCTS (NOT USED)

PART 3 – EXECUTION (NOT USED)

END OF SECTION 01 13 30

S201-ITB2, Volume 2 - SECTION 01 33 50 SPECIAL PROCEDURES

PART 1 - GENERAL

1.01 RELATED DOCUMENTS

- A. Construction Drawings, Technical Specifications, Addenda, and Contact Agreement, including any Addenda, including other Division 1 Specification Sections, apply to this Section.

1.02 SECTION INCLUDES

- A. Environmental protection procedures
- B. Smoke/odor control procedures
- C. Noise control procedures
- D. Dust and air pollution control procedures
- E. Hazardous materials procedures
- F. Welding and burning mitigation procedures
- G. Erosion and sediment control procedures (Storm Water Pollution Protection Plan)
- H. Disposal operations procedures
- I. Cultural resources procedures
- J. Alteration project procedures.

1.03 SITE DECORUM

Contractor shall control the conduct of labor forces and prevent unwanted interaction initiated by workers with the FORA staff, students or other individuals other than those associated with the Project.

In the event that any worker initiates unwanted interaction, uses profanity, or in the opinion of the FORA Construction Manager, conducts him/herself in an offensive or unprofessional manner, the Contractor shall immediately remove the worker from the project and replace said worker with another of equivalent technical skill at no cost to the FORA.

All Contractor personnel associated with the project shall wear shirts at all times and conduct themselves professionally in the presence of FORA staff and other people in the vicinity of the Project Site.

No smoking is allowed within any FORA facility.

No radios, other than 2-way communication type, will be allowed on the Project Site.

1.04 DIVERTED WASTE GOAL

Per AB939, California Integrated Solid Waste Management Act of 1989, requires FORA to reduce the amount of solid waste diverted to the land fill.

Before the release of retention, the Contractor must submit a spreadsheet to the FORA Construction Manager similar to the attached. The Contractor will also include original copies of the weight tickets with the spreadsheet.

1.05 ENVIRONMENTAL PROTECTION PROCEDURES

A. Environmental Protection Procedures, General: Requirements specified in this Section are in addition to those of Article 3 of the Contract Agreement.

1. During the progress of the work, keep the premises occupied in a neat and clean condition and protect the environment both on site and off site, throughout and upon completion of the construction project.
2. In coordination with the FORA, develop an Environmental Protection Plan in detail and submit to FORA Construction Manager for approval **within 7 calendar days** from the date of commencement specified in the Notice to Proceed. Distribute approved plan to all employees and to all subcontractors and their employees. Environmental Protection Plan shall include, but not be limited to, the following items:
 - a. Copies of required permits
 - b. Proposed sanitary landfill site
 - c. Other proposed disposal sites
 - d. Noise Control
 - e. Dust Control
 - f. Erosion and Sediment Control
 - g. Copies of any agreements with public or private landowners regarding equipment, materials storage, borrow sites, fill sites, or disposal sites. Such agreements made by Contractor shall be invalid if their execution causes violation of local or regional grading or land use regulations.

B. Environmental Protection: Provide protection, operate temporary facilities and conduct construction in ways and by methods that comply with environmental regulations, and minimize the possibility that air, waterways and subsoil might be contaminated or polluted, or that other undesirable effects might result.

1. Avoid use of tools and equipment that produce harmful noise. Restrict use of noise making tools and equipment to hours that will minimize complaints from persons or firms near the site.
2. Comply with noise control requirements specified below.

C. Construction Operations: All construction operations shall comply with all applicable Federal, State and local Codes, ordinances, statutes and regulations pertaining to water, air, solid waste and noise pollution. It shall be Contractor's responsibility to identify and

determine necessary measures to be taken to comply with such Codes, ordinances, statutes and regulations.

D. Definitions of Contaminants:

1. Sediment: Soil and other debris that have been eroded and transported by runoff water
2. Solid waste: Rubbish, debris, garbage and other discarded solid materials resulting from construction activities, including a variety of combustible and non-combustible wastes, such as ashes, waste materials that result from construction or maintenance and repair work, leaves and tree trimmings
3. Chemical waste: Includes petroleum products, bituminous materials, salts, acids, alkalis, herbicides, pesticides, disinfectants, organic chemicals and inorganic wastes. Some of the above may be classified as "hazardous"
4. Sanitary wastes:
 - a. Sewage: Domestic sanitary sewage
 - b. Garbage: Refuse and scraps resulting from preparation, cooking, dispensing and consumption of food.
 - c. Trimming: Refer to Section 01 56 80 - Tree and Plant Protection.
 - d. Excavations around trees: Refer to Section 01 56 80 - Tree and Plant Protection.
 - e. Repair and restoration: Repair or replace trees or other landscape feature scarred or damaged by equipment or construction operations as specified below. Repair and restoration plan shall be reviewed and approved by FORA Construction Manager prior to its initiation.

E. Protection of Natural Resources: It is intended that the natural resources within the Project boundaries and outside the limits of permanent work performed under this Contract be preserved in their existing condition or be restored to an equivalent or improved condition upon completion of the work. Confine construction activities to areas defined by the public roads, easements, and work area limits shown on the drawings. Return construction areas to their pre-construction elevations except where surface elevations are otherwise noted to be changed. Maintain natural drainage patterns. Conduct construction activities such that ponding of stagnant water conducive to mosquito breeding habitat will not occur at any time.

1. Land resources protection: Do not remove, cut, deface, injure or destroy trees or shrubs outside the work area limits. Do not remove, deface, injure or destroy trees within the Project area without permission from FORA Construction Manager. Such improvements shall be removed and replaced, if required, by the Contractor at no change in Contract Time and Contract Sum.
2. Landscaping protection: Protect trees that are located near the limits of Project area which may possibly be defaced, bruised or injured or otherwise damaged by the Contractor's operations. No ropes, cables or guys shall be fastened to or be attached to any existing nearby trees or shrubs for anchorages. Refer to additional requirements specified in Section 01 56 00 - Temporary Barriers and Controls.
3. Temporary construction:
 - a. Remove all signs of temporary construction facilities such as haul roads, work areas,

structures, foundations of temporary structures, stockpiles of excess or waste materials, or any other vestiges of construction as directed by the FORA Construction Manager.

- b. Level all temporary roads, parking areas and any other areas that have become compacted or shaped.
 - c. Unpaved areas where vehicles have been operated shall receive suitable surface treatment or shall be periodically wetted down to prevent construction operations from producing dust damage and nuisance to persons and property, at no additional cost to the Trustees.
 - d. Keep haul roads clear at all times of any object that creates an unsafe condition. Promptly remove any contaminants or construction materials dropped from construction vehicles. Do not drop mud and debris from construction equipment on public streets. Sweep clean turning areas and pavement entrances as necessary.
4. Water resources: Comply with all applicable Federal, State and local Codes, ordinances, statutes and regulations pertaining to discharge (directly or indirectly) of pollutants to underground and natural waters.
- a. Perform all Work under the Contract in a manner that any adverse environmental impacts are reduced to a level that is acceptable to FORA Construction Manager and authorities having jurisdiction.
5. Oily Substances: At all times, special measures shall be taken to prevent oily or other hazardous substances from entering the ground, drainage areas or local bodies of water in such quantities as to affect normal use, aesthetics or produce a measurable impact upon the areas. All soil or water that is contaminated with oily substances due to Contractor's operations shall be disposed of in accordance with applicable regulations, at no change in Contract Time and Contract Sum.

1.06 SMOKE/ODOR CONTROL PROCEDURES

- A. Smoke/Odor Control: Protect primary fresh air intakes to existing buildings from exhaust from internal combustion engines, paint and solvent fumes and other noxious fumes and vapors.
1. Implement control methods such as snorkels from engines exhausts to 50 feet away from air intakes. Provide carbon filters on air intakes as necessary, including periodic replacement of filters to ensure effectiveness.
 2. All other activities generating fumes shall be limited to minimum distance of 50 feet from air intake grilles.
 3. If fume-generating procedures must occur within 50 feet of an air intake, Contractor shall do the following:
 - a. Notify FORA Construction Manager at least 14 calendar days in advance of such activities.
 - b. Perform Work when it least impacts the other activities at the Project Site (evenings, weekends or particularly windy days).
 - c. Provide carbon filter media, plastic barriers, or other control methods to ensure

fresh air only enters into the building ventilation system.

1.07 NOISE CONTROL PROCEDURES

- A. Noise Control Procedures, General: Maximum noise levels within 1,000 feet of classrooms, laboratories, residences, businesses, adjacent buildings and other populated areas:
 - 1. Noise levels for trenchers, pavers, graders and trucks: Not exceeding 95 dBA at the project limits as measured under noisiest operating conditions.
 - 2. Noise levels for all other equipment: Not exceeding 85 dBA at the project limits.
- B. Noise Control of Equipment:
 - 1. Equip jackhammers with exhaust mufflers and steel muffling sleeves.
 - 2. Use air compressors of a quiet type such as a "whisperized" compressor. Compressor hoods shall be closed while equipment is in operation.
 - 3. Provide portable noise barriers around jack hammering, with barriers constructed of 3/4 inch plywood lined with 1-inch thick ductliner type fiberglass on Work side.
- C. Noise Control of Construction Operations:
 - 1. Keep noisy equipment as far as possible from noise-sensitive site boundaries.
 - 2. Machines shall not be left idling.
 - 3. Use electric power in lieu of internal combustion engine power whenever possible.
 - 4. Maintain equipment properly to reduce noise from excessive vibration, faulty mufflers, or other sources. All engines shall have properly functioning mufflers.
- D. Scheduling of Noisy Operations: Schedule construction activities to minimize time of noisy operations and disruption to occupants of adjoining facilities. Notify University's Representative in advance of performing Work creating unusual noise and schedule such Work at times mutually agreeable.
- E. Accessory Noise: Do not play radios, tape recorders, televisions, and other similar items at construction site.

1.08 DUST AND AIR POLLUTION CONTROL PROCEDURES

- F. Dust and Air Pollution Control Procedures, General: Requirements of this Section are in addition to those of Article 3 of the Contract Agreement. Employ measures to prevent or minimize creation of dust and air pollution. Contractor shall appoint a dust control monitor to oversee and implement all measures specified in this Article.
 - 1. Unpaved areas shall be wetted down, to eliminate dust formation, a minimum of twice a day to reduce particulate matter. When wind velocity exceeds 15 mph, site shall be watered down more frequently.
 - 2. Store all volatile liquids, including fuels or solvents in closed containers.
 - 3. No on-site burning of debris, lumber and other scrap shall be permitted.
 - 4. Properly maintain equipment to reduce gaseous pollutant emissions.

5. Exposed areas, new driveways and sidewalks shall be seeded, treated with soil binders or paved, as appropriate, as soon as possible.
6. Cover stockpiles of soil, sand and other loose materials.
7. Cover trucks hauling soil, debris, sand or other loose materials.
8. Sweep project area streets at least once daily. Refer to Section 01 74 00 - Cleaning Requirements.

1.09 WELDING AND BURNING MITIGATION PROCEDURES

- A. Welding and Burning Mitigation Procedures: Eliminate welding and burning of steel as much as possible. Where unavoidable, perform welding and burning with all possible precaution to avoid fire hazard. Provide a fire watch for minimum of 30 minutes after burning stops. Provide protection for all adjacent surfaces.

1.010 EROSION AND SEDIMENT CONTROL PROCEDURES

- A. Erosion and Sediment Control Procedures: Refer to runoff control requirements specified in Section 01 57 00 - Temporary Controls. Obtain and comply with Storm Water Pollution Protection Plan (SWPPP) and project-specific requirements indicated on Civil Drawings.

1.011 DISPOSAL OPERATIONS PROCEDURES

- A. Solid Waste Management:
 1. Supply solid waste transfer containers. Daily remove all debris such as spent air filters, oil cartridges, cans, bottles, combustibles and litter. Take care to prevent trash and papers from blowing onto adjacent property. Encourage personnel to use refuse containers. Convey contents to a sanitary landfill.
 2. Washing of concrete containers where wastewater may reach adjacent property, storm drains or natural water courses will not be permitted. Remove any excess concrete to the sanitary landfill.
- B. Chemical Waste and Hazardous Materials Management: furnish containers for storage of spent chemicals used during construction operations. Dispose of chemicals and hazardous materials in accordance with applicable regulations.
- C. Garbage: Store garbage in covered containers, pick up daily and dispose of in a sanitary landfill.
- D. Grading Spoil and Landscape Debris: Dispose of vegetation, weeds, rubble, and other materials removed by the clearing, stripping and grubbing operations off site at a suitable disposal site in accordance with applicable Federal, State and local Codes, ordinances, statutes and regulations
- E. Excavated Materials:
 1. Native soil complying may be used for backfill, fill and embankments
 2. Remove all material which is excavated in excess of that required for backfill. Dispose of unsuitable excavated material from the site and dispose of it legally.

- a. Excess suitable backfill material shall be hauled off site. No additional compensation will be paid to the Contractor for such off haul. Include all such costs in the Contract Sum.
- b. Unsuitable backfill material shall be disposed of off-site in accordance with applicable regulations, in a disposal site indicated in the Environmental Protection Plan.
- c. Remove rubbish and materials unsuitable for backfill immediately following excavation.
- d. Remove material in excess of that required for backfill immediately following backfill operations.

1.12 CULTURAL RESOURCES PROCEDURES

A. Cultural Resources Procedures:

1. It is conceivable that unrecorded archaeological sites could be discovered during the excavation of the Rolling Pin building basement.
2. In the event that artifacts, human remains, or other cultural resources are discovered during subsurface excavations at locations of the Work, the Contractor shall protect the discovered items, cease work for a distance of 35 feet radius in the area, notify the FORA Construction Manager and comply with applicable law.
3. FORA may retain an Archaeologist to monitor and recover data and artifacts during period that work has ceased.
4. All items found which are considered to have archaeological significance are the property of FORA.

PART 2 – PRODUCTS (NOT USED)

PART 3 – EXECUTION (NOT USED)

END OF SECTION 01 33 50

S201-ITB1, Volume 2 - SECTION 01 33 55 – Safety and Health Procedures

PART 1 - GENERAL

1.01 RELATED DOCUMENTS

- A. Construction Drawings, Technical Specifications, Addenda, and Contact Agreement, including any Addenda, including other Division 1 Specification Sections, apply to this Section.

1.02 SECTION INCLUDES

- A. Procedures for health and safety protection and requirements for reporting accidents.

1.03 RELATED SECTIONS

- A. Section 01 56 00 - Temporary Barriers and Enclosures

1.04 SUBMITTALS

- A. Accident Reporting: A copy of each accident report, which FORA and FORA Construction Manager as soon as possible, but in no event later than seven (7) calendar days after the day the accident occurred.
- B. Other Submittals: If agreed to in writing at the preconstruction safety meeting, other submittals shall be required. One such submittal that may be included is a plan of action for handling hazardous materials to contain the following:
 - 1. Number, type, and experience of employees to be used for the Work
 - 2. Description of how safety and health regulations and standards shall be met
 - 3. Type of protective equipment and work procedures to be used
 - 4. Emergency procedures for accidental spills or exposures.

PART 2 - PRODUCTS

2.01 GENERAL

- A. Special facilities, devices, equipment, clothing, and similar items used by the Contractor in the execution of the Work shall comply with applicable regulations.

PART 3 - EXECUTION

3.01 STOP WORK ORDERS

- A. Stop Work Orders:
 - 1. When the Contractor or its subcontractors are notified by FORA Construction Manager or FORA Certified Industrial Hygienist of an incident of noncompliance with the provisions of the Contract, and the action(s) to be taken, the Contractor shall

immediately, if so directed, or within 48 hours after receipt of a notice of violation, correct the unsafe or unhealthy condition.

2. If the Contractor fails to comply promptly, all or any part of the work performed may be stopped by with a "Stop Work Order." When, in the opinion of the FORA Construction Manager or Certified Industrial Hygienist, satisfactory corrective action has been taken to correct the unsafe and unhealthy condition, a start order will be given immediately.
3. The Contractor shall not be allowed any extension of time or compensation for damages by reason of or in connection with such work stoppage.

3.02 PROTECTION

- B. Protection: Contractor shall take all necessary precautions to prevent injury to the public, building occupants, or damage to property of others.
 4. For the purposes of the Contract, the public or building occupants shall include all persons not employed by the Contractor or a subcontractor working under the Contractor's direction.
 5. Work shall not be performed in any area occupied by the public or FORA's contractors unless specifically permitted by the Contract or the FORA Construction Manager and unless adequate steps are taken for the protection of the public and the FORA's contractors.
 6. Whenever practicable, the work area shall be fenced, barricaded, or otherwise blocked off from the public or building occupants to prevent unauthorized entry into the work area.
- C. Alternate Precautions: When the nature of the Work prevents isolation of the work area, and the public or building occupants may be in or pass through, under or over the work area, alternate precautions such as the posting of signs, the use of signal persons, the erection of barricades or similar protection around particularly hazardous operations shall be used as appropriate.
- D. Public Thoroughfare: When Work is to be performed over a public thoroughfare such as a sidewalk, lobby, or corridor, the thoroughfare shall be closed, if possible, or other precautions taken such as the installation of screens or barricades. When the exposure to heavy falling objects exists, as during the erection of building walls or during demolition, special protection of the type detailed in 29 CFR 1910/1926 shall be provided.
- E. Hazardous Conditions: Storing, positioning or use of equipment, tools, materials, scraps, and trash in a manner likely to present a hazard to the public or building occupants by its accidental shifting, ignition, or other hazardous qualities is prohibited.

END OF SECTION 01 33 55

S201-ITB1, Volume 2 - SECTION 01 41 00 – REGULATORY REQUIREMENTS

PART 1 - GENERAL

1.01 RELATED DOCUMENTS

- A. Construction Drawings, Technical Specifications, Addenda, and Contact Agreement, including any Addenda, including other Division 1 Specification Sections, apply to this Section.

1.02 AUTHORITY AND PRECEDENCE OF CODES, ORDINANCES AND STANDARDS

- A. Authority: All codes, ordinances and standards referenced in the Drawings and Specifications shall have the full force and effect as though printed in their entirety in the Specifications.
- B. Precedence:
 - 1. Where specified requirements differ from the requirements of applicable codes, ordinances and standards, the more stringent requirements shall take precedence.
 - 2. Where the Drawings or Specifications require or describe products or execution of better quality, higher standard or greater size than required by applicable codes, ordinances and standards, the Drawings and Specifications shall take precedence so long as such increase is legal.
 - 3. Where no requirements are identified in the Drawings or Specifications, comply with all requirements of applicable codes, ordinances and standards of authorities having jurisdiction.

1.1 APPLICABLE CODES, LAWS AND ORDINANCES

- A. Applicable Codes, Laws and Ordinances: Refer also to Section 01 11 00 - Summary of Work regarding permits and licenses.
 - 1. Performance of the Work shall meet or exceed the minimum requirements of California Code of Regulations (CCR), Title 24, including the following:
 - a. CCR Title 24, Part 1: 2016 California Administrative Code.
 - b. CCR Title 24, Part 2: 2016 California Building Code (CBC), Based on the 2015 International Building Code (IBC) Volumes 1 and 2.
 - c. CCR Title 24, Part 3: 2016 California Electrical Code (CEC); Based on the 2014 National Electrical Code (NEC), NFPA 70 (NEC).
 - d. CCR Title 24, Part 4: 2016 California Mechanical Code (CMC); Based on the 2015 Uniform Mechanical Code (UMC).
 - e. CCR Title 24, Part 5: 2016 California Plumbing Code (CPC); Based on the 2015 Uniform Plumbing Code (UPC).
 - f. CCR Title 24, Part 6: 2016 California Energy Efficiency Standards (CES).

- g. CCR Title 24, Part 9: 2016 California Fire Code (CFC); Based on the 2015 International Fire Code.
 - h. CCR Title 24, Part 11: 2016 California Green Buildings Standards Code (CAL GREEN).
 - i. CCR Title 24, Part 12: 2016 California Reference Standards Code.
 - j. ADA Title II and III (2010 Standards).
 - k. NFPA 13: Automatic Sprinkler Systems, 2016 Edition.
 - l. NFPA 72: National Fire Alarm and Signaling Code, 2016 Edition.
2. Performance of the Work shall also comply with applicable requirements of California Code of Regulations (CCR) as follows:
- a. Title 19 – C.C.R. Public Safety, SFM Regulations, 2016 edition.
 - b. Title 22 - Social Security, 2016 edition.
3. References on the Drawings or in the Specifications to "code", "Code" or "building code" similar terms, not otherwise identified, shall mean the codes specified above, together with all additions, amendments, changes, and interpretations adopted by code authorities of the jurisdiction having authority over the Project.
4. The applicable edition of all codes shall be that adopted at the time of issuance of permits by the authority having jurisdiction and shall include all modifications and additions adopted by that authority. The applicable date of laws and ordinances shall be that of the date of performance of the Work.
- B. Other Applicable Laws, Ordinances and Regulations:
- 1. Work shall be accomplished in conformance with all applicable laws, ordinances, rules and regulations of Federal, State, County, City and special district agencies and jurisdictions having authority over the Project.
 - 2. Performance of the Work shall be accomplished in conformance with all rules and regulations of public utilities, utility districts and other agencies serving the facility.
 - 3. Where such laws, ordinances, rules and regulations require more care or greater time to accomplish Work, or require better quality, higher standards or greater size of products, Work shall be accomplished in conformance to such requirements with no change to the Contract Time and Contract Sum, except where changes in laws, ordinances, rules and regulations occur subsequent to the execution date of the Agreement.

PART 2 – PRODUCTS (NOT USED)

PART 3 – EXECUTION (NOT USED)

END OF SECTION 01 41 00

S201-ITB1, Volume 2 - SECTION 01 42 00 – REFERENCE STANDARDS AND ABBREVIATIONS

PART 1 - GENERAL

1.01 RELATED DOCUMENTS

- A. Construction Drawings, Technical Specifications, Addenda, and Contact Agreement, including any Addenda, including other Division 1 Specification Sections, apply to this Section.

1.02 SECTION INCLUDES

- A. Use of references in Drawings and Specifications, including requirements for copies of reference standards at Project site.
- B. Definitions of terms used in Specifications and Drawings, including abbreviations, acronyms, names and terms which may be used in Specifications.

1.03 RELATED SECTIONS

- A. Section 01 41 00 - Regulatory Requirements

1.04 USE OF REFERENCES

- A. References: The Drawings and Specifications contain references to various standards, standard specifications, codes, practices and requirements for products, execution, tests and inspections. These reference standards are published and issued by the agencies, associations, organizations and societies listed in this Section or identified in individual product specification Sections.
 - 1. Wherever term "Agency" occurs in Standard Specifications, it shall be understood to mean the term used for FORA for purposes of the Contract.
 - 2. Wherever term "Engineer" occurs in Standard Specifications, it shall be understood to mean FORA consultant or other responsible design professional for purposes of the Contract.
 - 3. Where reference is made to Standard Details, such reference shall be to the Standard Details accompanying the Standard Specifications.
- B. Relationship to Drawings and Specifications: Such references are incorporated into and made a part of the Drawings and Specifications to the extent applicable.
- C. Referenced Grades Classes and Types: Where an alternative or optional grade, class or type of product or execution is included in a reference but is not identified on the Drawings or in the Specifications, provide the highest, best and greatest of the alternatives or options for the intended use and prevailing conditions.

D. Copies of Reference Standards:

1. Reference standards are not furnished with the Drawings and Specifications because it is presumed that the Contractor, subcontractors, manufacturers, suppliers, trades and crafts are familiar with these generally-recognized standards of the construction industry.
2. Copies of reference standards may be obtained from publishing sources.

E. Jobsite Copies:

1. Contractor shall obtain and maintain at the Project site copies of reference standards identified on the Drawings and in the Specifications in order to properly execute the Work.
2. At a minimum, the following shall be readily available at the site, as applicable to the Work:
 - a. State Building Codes: As referenced in Section 01 41 10 - Regulatory Requirements.
 - b. Safety Codes: Occupational Safety and Health Act (OSHA) regulations and State of California, California Administrative Code, California Code of Regulations (CCR), Title 8 - Industrial Relations, Chapter 4, Subchapter 7, General Industry Safety Orders (Cal-OSHA), to extent applicable to the Work.
 - c. General Standards:
 1. CCR Title 24, Part 2, Volume 3: 2016 California Building Code (CBC) Material, Testing and Installation Standards.
 2. CCR Title 24, Part 12: 2016 California Referenced Standards Code.
 3. Underwriters Laboratories, Inc. (UL) Building Products Listing.
 4. Factory Mutual Research Organization (FM) Approval Guide.
 5. American Society for Testing and Materials (ASTM) Standards in Building Codes.
 6. American National Standards Institute (ANSI) standards.
 - d. Fire and Life Safety Standards: All referenced standards pertaining to fire rated construction and exiting.
 - e. Common Materials Standards: American Concrete Institute (ACI), American Institute of Steel Construction (AISC), American Welding Society (AWS), Gypsum Association (GA), National Fire Protection Association (NFPA), Tile Council of America (TCA) and Woodwork Institute of California (WIC) standards to the extent referenced within the Contract Specifications.
 - f. Research Reports: ICC Evaluation Service, Inc. (ICC-ES), formerly ICBO Evaluation Service, Inc. (ICBO ES) Research Reports and National Evaluation Service, Inc. Reports (NER), for products not in conformance to prescribed requirements stated in California Building Code (CBC).
 - g. Product Listings: Approval documentation, indicating approval of authorities having jurisdiction for use of product within the applicable jurisdiction.

F. Edition Date of References:

1. When an edition or effective date of a reference is not given, it shall be understood to be the current edition or latest revision published as of the date of the Contract Drawings and Contract Specifications.
2. All amendments, changes, errata and supplements as of the effective date shall be included.

G. ASTM and ANSI References: Specifications and Standards of the American Society for Testing and Materials (ASTM) and the American National Standards Institute (ANSI) are identified in the Drawings and Specifications by abbreviation and number only and may not be further identified by title, date, revision or amendment. It is presumed that the Contractor is familiar with and has access to these nationally- and industry-recognized specifications and standards.

1.05 DEFINITIONS OF TERMS

A. Basic Contract Definitions: Words and terms governing the Work are defined in the Contract Agreement.

B. Words and Terms Used on Drawings and in Specifications: Additional words and terms may be used in the Drawings and Specifications and are defined as follows:

1. "Applicable:" As appropriate for the particular condition, circumstance or situation.
2. "Approve(d):" Approval action shall be limited to the duties and responsibilities of the party giving approval, as stated in the Conditions of the Contract. Approvals shall be valid only if obtained in writing and shall not apply to matters regarding the means, methods, techniques, sequences and procedures of construction. Approval shall not relieve the Contractor from responsibility to fulfill Contract requirements.
3. "And/or:" If used, shall mean that either or both of the items so joined are required.
4. "Directed:" Limited to duties and responsibilities of the FORA Construction Manager as stated in the Contract Agreement, meaning "as instructed by the FORA Construction Manager, in writing, regarding matters other than the means, methods, techniques, sequences and procedures of construction. Terms such as "directed", "requested", "authorized", "selected", "approved", "required", and "permitted" mean "directed by FORA or the FORA Construction Manager", "requested by FORA or the FORA Construction Manager", and similar phrases. No implied meaning shall be interpreted to extend the responsibility of the FORA Construction Manager or FORA's consultants into the Contractor's supervision of construction.
5. "Equal" or "Equivalent:" As determined by FORA Construction Manager or other responsible design professional as being equivalent, considering such attributes as durability, finish, function, suitability, quality, utility, performance and aesthetic features.
6. "Furnish:" Means "supply and deliver, to the Project site, ready for unloading, unpacking, assembly, installation, and similar operations."
7. "Indicated:" The term indicated refers to graphic representations, notes, or schedules on the Drawings, or other Paragraphs or Schedules in the Specifications, and similar requirements in the Contract Documents. Terms such as "shown", "noted", "scheduled", and "specified" are used to help the reader locate the reference. There is no limitation on location.

8. "Install:" Describes operations at the Project site including the actual unloading, unpacking, assembly, erection, placing, anchoring, applying, working to dimension, finishing, curing, protecting, cleaning and similar operations.
9. "Installer:"
 - a. "Installer" refers to the Contractor or an entity engaged by the Contractor, such as an employee, subcontractor, or sub-subcontractor for performance of a particular construction activity, including installation, erection, application and similar operations. Installers are required to be experienced in the operations they are engaged to perform.
 - b. "Experienced Installer:" The term "experienced," when used with "installer" means having a minimum of five (5) previous Projects similar in size to this Project, knowing the precautions necessary to perform the Work, and being familiar with requirements of authorities having jurisdiction over the Work.
10. "Jobsite:" Same as site.
11. "Necessary:" With due considerations of the conditions of the Project and as determined in the professional judgment of the FORA Construction Manager or other responsible design professional as being necessary for performance of the Work in conformance with the requirements of the Contract Documents, but excluding matters regarding the means, methods, techniques, sequences and procedures of construction.
12. "Noted:" Same as "Indicated."
13. "Per:" Same as "in accordance with," "according to" or "in compliance with."
14. "Products:" Material, system or equipment.
15. "Project Site:" Same as "Site."
16. "Proper:" As determined by the or other responsible design professional as being proper for the Work, excluding matters regarding the means, methods, techniques, sequences and procedures of construction, which are solely the Contractor's responsibility to determine.
17. "Provide:" Means "furnish and install, complete and ready for the intended use."
18. "Regulation:" Includes laws, ordinances, statutes and lawful orders issued by authorities having jurisdiction, as well as and rules, conventions and agreements within the construction industry that control performance of the Work.
19. "Required:" Necessary for performance of the Work in conformance with the requirements of the Contract Documents, excluding matters regarding the means, methods, techniques, sequences and procedures of construction, such as:
 - a. Regulatory requirements of authorities having jurisdiction.
 - b. Requirements of referenced standards.
 - c. Requirements generally recognized as accepted construction practices of the locale.
 - d. Notes, schedules and graphic representations on the Drawings.
 - e. Requirements specified or referenced in the Specifications.
 - f. Duties and responsibilities stated in the Bidding and Contract Requirements.
20. "Scheduled:" Same as "Indicated."

21. "Selected:" As selected by FORA or the FORA Construction Manager or other responsible design professional from the full selection of the manufacturer's products, unless specifically limited in the Contract Documents to a particular quality, color, texture or price range.
22. "Shown:" Same as "Indicated."
23. "Site:" Same as "Site of the Work" or "Project Site;" the area or areas or spaces occupied by the Project and including adjacent areas and other related areas occupied or used by the Contractor for construction activities, either exclusively or with others performing other construction on the Project. The extent of the Project Site is shown on the Drawings, and may or may not be identical with the description of the land upon which the Project is to be built.
24. "Supply:" See "Furnish."
25. "Testing Laboratory" or "Testing Laboratories:" An independent entity engaged to perform specific inspections or tests, at the Project Site or elsewhere, and to report on, and, if required, to interpret, results of those inspections or tests. Refer to Section 01 45 80 - Testing Laboratory Services.
26. "Testing and Inspection Agency:" Same as "Testing Laboratory."

1.06 ABBREVIATIONS, ACRONYMS, NAMES AND TERMS, GENERAL

- A. Abbreviations, Acronyms, Names and Terms: Where acronyms, abbreviations, names and terms are used in the Drawings, Specifications or other Contract Documents, they shall mean the recognized name of the trade association, standards generating organization, authority having jurisdiction or other entity applicable.
- B. Abbreviations, General: The following are commonly-used abbreviations which may be found on the Drawings or in the Specifications:

AC or ac	Alternating current or air conditioning (depending upon context)
AMP or amp	Ampere
C	Celsius
CFM or cfm	Cubic feet per minute
CM or cm	Centimeter
CY or cy	Cubic yard
DC or dc	Direct current
DEG or deg	Degrees
F	Fahrenheit
FPM or fpm	Feet per minute
FPS or fps	Feet per second
FT or ft	Foot or feet
Gal or gal	Gallons
GPM or gpm	Gallons per minute
IN or in	Inch or inches
Kip or kip	Thousand pounds
KSI or ksi	Thousand pounds per square inch
KSF or ksf	Thousand pounds per square foot
KV or kv	Kilovolt
KVA or kva	Kilovolt amperes

KW or kw	Kilowatt
KWH or kwh	Kilowatt hour
LBF or lbf	pounds force
LF or lf	Lineal foot
M or m	Meter
MPH or mph	Miles per hour
MM or mm	Millimeter
PCF or pcf	Pounds per cubic foot
PSF or psf	Pounds per square foot
PSI or psi	Pounds per square inch
PSY or psy	Per square yard
SF or sf	Square foot
SY or sy	Square yard
V or v	Volts

- C. Abbreviations and Acronyms for Industry Organizations: Where abbreviations and acronyms are used in Specifications or other Contract Documents, they shall mean the recognized name of the entities indicated in Gale Research's "Encyclopedia of Associations" or in Columbia Books' "National Trade & Professional Associations of the U.S."
- D. Undefined Abbreviations, Acronyms, Names and Terms: Words and terms not otherwise specifically defined in this Section, in the Instructions to Bidders, in the Contract General Conditions, on the Drawings or elsewhere in the Specifications, shall be as customarily defined by trade or industry practice, by reference standard and by specialty dictionaries such as the following:
1. Dictionary of Architecture and Construction, Third Edition (Cyril M. Harris, McGraw-Hill Book Company, 2000).
 2. The American Institute of Architects (AIA) Document M101, "Glossary of Construction Industry Terms."
 3. Encyclopedia of Associations, published by Gale Research Co., commonly available in public libraries.

PART 2 – PRODUCTS (NOT USED)

PART 3 – EXECUTION (NOT USED)

END OF SECTION 01 42 00

S201-ITB1, Volume 2 - SECTION 01 45 00 – QUALITY CONTROL

PART 1 - GENERAL

1.01 RELATED DOCUMENTS

- A. Construction Drawings, Technical Specifications, Addenda, and Contact Agreement, including any Addenda, including other Division 1 Specification Sections, apply to this Section.

1.02 SECTION INCLUDES

vsmplus

- A. Regulatory requirements for testing and inspection.
- B. Contractor's quality control.
- C. Quality of the Work.
- D. Inspections and tests by authorities having jurisdiction.
- E. Inspections and tests by serving utilities.
- F. Inspections and tests by manufacturer's representatives.

1.03 RELATED SECTIONS

- A. Section 01 41 00 - Regulatory Requirements.
- B. Section 01 45 58 - Testing Laboratory Services.

1.04 REGULATORY REQUIREMENTS FOR TESTING AND INSPECTION

- A. Building Code Requirements: Comply with requirements for testing and inspections in the California Building Code (CBC), as interpreted by authorities having jurisdiction. Additional requirements for testing and inspection, as adopted by authorities having jurisdiction, shall be included in the Contract Sum and Contract Time.
- B. Requirements of Fire Regulations: Comply with testing and inspection requirements of the Fire Marshal having jurisdiction. All tests and inspections shall be included in Contract Sum and Contract Time.

1.05 CONTRACTOR'S QUALITY CONTROL

- A. Contractor's Quality Control: Contractor shall ensure that products, services, workmanship and site conditions comply with requirements of the Drawings and Specifications by coordinating, supervising, testing and inspecting the Work and by utilizing only suitably qualified personnel.
- B. Quality Requirements: Work shall be accomplished in accordance with quality requirements of the Drawings and Specifications, including, by reference, all Codes, laws, rules, regulations and standards. When no quality basis is prescribed, the quality shall be in accordance with the

best accepted practices of the construction industry for the locale of the Project, for projects of this type.

- C. Quality Control Personnel: Contractor shall employ and assign knowledgeable and skilled personnel as necessary to perform quality control functions to ensure that the Work is provided as required.
- D. Coordination of Field Quality Control: Contractor shall coordinate and schedule field quality control activities of FORA's independent testing and inspection agency and inspectors from authorities having jurisdiction.

1.06 QUALITY OF THE WORK

- A. Quality of Products: Unless otherwise indicated or specified, all products shall be new, free of defects and fit for the intended use.
- B. Quality of Installation: All Work shall be produced plumb, level, square and true, or true to indicated angle, and with proper alignment and relationship between the various elements.
- C. Protection of Existing and Completed Work: Take all measures necessary to preserve and protect existing and completed Work free from damage, deterioration, soiling and staining, until Acceptance by the FORA Construction Manager.
- D. Standards and Code Compliance and Manufacturer's Instructions and Recommendations: Unless more stringent requirements are indicated or specified, comply with manufacturer's instructions and recommendations, reference standards and building code research report requirements in preparing, fabricating, erecting, installing, applying, connecting and finishing Work.
- E. Deviations from Standards and Code Compliance and Manufacturer's Instructions and Recommendations: Document and explain all deviations from reference standards and building code research report requirements and manufacturer's product installation instructions and recommendations, including acknowledgement by the manufacturer that such deviations are acceptable and appropriate for the Project.
- F. Verification of Quality: Work shall be subject to verification of quality by FORA Construction Manager or by FORA Certified Industrial Hygienist in accordance with provisions of the Contract Agreement.
 - 1. Contractor shall cooperate by making Work available for inspections and observations by FORA Construction Manager or by FORA Certified Industrial Hygienist and FORA's consultants.
 - 2. Such verification may include mill, plant, shop, or field inspection, as required.
 - 3. Provide access to all parts of the Work, including plants where materials or equipment are manufactured or fabricated.
 - 4. Provide all information and assistance as necessary, including that from subcontractors, fabricators, materials suppliers and manufacturers, for verification of quality by FORA Construction Manager.
 - 5. Contract modifications, if any, resulting from such verification activities shall be governed by applicable provisions in the Contract Agreement.
- G. Observations by FORA and/or FORA Construction Manager and/ or by FORA Certified

Industrial Hygienist: Periodic and occasional observations of Work in progress will be made by FORA Construction Manager as deemed necessary to review progress of Work and general conformance with the design intent.

- H. Limitations on Inspection, Test and Observations: Employment of an independent testing and inspection agency and observations by FORA Construction Manager shall not relieve Contractor of the obligation to perform Work in full conformance to all requirements of Contract Documents and applicable Building Code and other regulatory requirements.
- I. Rejection of Work: FORA and FORA Construction Manager or by FORA Certified Industrial Hygienist reserves the right to reject any and all Work not in conformance to the requirements of the Contract Documents.
- J. Correction of Non-Conforming Work: Non-conforming Work shall be modified, replaced, repaired or redone by the Contractor at no change in Contract Sum or Contract Time.
- K. Acceptance of Non-Conforming Work: Acceptance of non-conforming Work, without specific written acknowledgement and approval of the FORA Construction Manager, shall not relieve the Contractor of the obligation to correct such Work.
- L. Contract Adjustment for Non-conforming Work: Should FORA Construction Manager determine that it is not feasible or not in FORA's interest to require non-conforming Work to be repaired or replaced, an equitable reduction in Contract Sum shall be made by agreement between FORA Construction Manager and Contractor.
- M. Non-Responsibility for Non-Conforming Work: Architect and Architect's consultants disclaim any and all responsibility for Work produced that is not in conformance with the Contract Drawings and Contract Specifications.

1.07 INSPECTIONS AND TESTS BY AUTHORITIES HAVING JURISDICTION

- A. Inspections and Tests by Authorities Having Jurisdiction: Contractor shall cause all tests and inspections required by authorities having jurisdiction to be made for Work under this Contract.
 - 1. Except as specifically noted, scheduling, coordinating and conducting such inspections and tests shall be solely the Contractor's responsibility.
 - 2. All time required for inspections and tests by authorities having jurisdiction shall be included in the Contract Time.
 - 3. Costs for inspections and tests by authorities having jurisdiction will be paid by FORA.

1.08 INSPECTIONS AND TESTS BY SERVING UTILITIES

- A. Inspections and Tests by Serving Utilities: Contractor shall cause all tests and inspections required by serving utilities to be made for Work under the Contract.
 - 1. Except as specifically noted, scheduling, coordinating and conducting such inspections and tests shall be solely the Contractor's responsibility. All time required for inspections and tests by serving utilities shall be included in the Contract Time.
 - 2. Except as specifically noted, all costs for inspections and tests by serving utilities shall be included in the Contract Sum.

1.09 INSPECTIONS AND TESTS BY MANUFACTURER'S REPRESENTATIVES

- A. Inspections and Tests by Manufacturer's Representatives: Contractor shall cause all specified tests and inspections to be conducted by materials or systems manufacturers. Additionally, all tests and inspections required by materials or systems manufacturers as conditions of warranty or certification of Work shall be made, the cost of which shall be included in the Contract Sum.
1. Scheduling, coordinating and conducting such inspections and tests shall be solely the Contractor's responsibility. All time required for inspections and tests by manufacturer's representatives shall be included in the Contract Time.
 2. All costs for inspections and tests by manufacturer's representatives shall be included in the Contract Sum.

1.1 INSPECTIONS BY INDEPENDENT TESTING AND INSPECTION AGENCY

- A. Inspections by independent Testing Laboratory: Refer to Section 01 45 80 - Testing Laboratory Services.

PART 2 – PRODUCTS (NOT USED)

PART 3 – EXECUTION (NOT USED)

END OF SECTION 01 45 00

S201-ITB1, Volume 2 - SECTION 01 1 45 80 – TESTING LABORATORY SERVICES

PART 1 - GENERAL

1.01 RELATED DOCUMENTS

- A. Construction Drawings, Technical Specifications, Addenda, and Contact Agreement, including any Addenda, including other Division 1 Specification Sections, apply to this Section.

1.02 SECTION INCLUDES

- A. Administrative and procedural requirements for quality control services.
 - 1. Quality control services include inspections and tests and related actions including reports, performed by independent agencies, and governing authorities. They do not include Contract enforcement activities performed by the FORA Construction Manager.
 - 2. Inspection and testing services are required to verify compliance with requirements specified or indicated. These services do not relieve the Contractor of responsibility for compliance with Contract Document requirements.
 - 3. This section covers the Geotechnical Testing required on this project. Additional Testing be required by the Contractor as it related to Hazardous Materials and will be covered in additional sections.

1.03 RELATED SECTIONS

- A. Section 01 45 00 - Quality Control.
- B. Individual Product Specifications Sections: Specific requirements for inspections and tests.

1.04 RESPONSIBILITIES

- A. Testing Laboratory: FORA will engage and pay for the services of an independent agency to perform inspections and tests specified as the FORA's responsibility.
 - 1. Where FORA have engaged a testing agency or other entity for testing and inspection of a part of the Work, and the Contractor is also required to engage an entity for the same or related element, the Contractor shall not employ the entity engaged by the Trustees, unless otherwise agreed in writing with the Trustees.
- B. Retesting: The Contractor is responsible for the cost of retesting where results of required inspections, tests or similar services prove unsatisfactory and do not indicate compliance with Contract Document requirements, regardless of whether the original test was the Contractor's
 - 1. Cost of retesting construction revised or replaced by the Contractor is the Contractor's responsibility, where required tests were performed on original construction.
- C. Associated Services: The Contractor shall cooperate with agencies performing required inspections, tests and similar services and provide reasonable auxiliary services as requested.

- D. Coordination: The Contractor, Project Manager/Inspector, and each agency engaged to perform inspections, testing and similar services shall coordinate the sequence of activities to accommodate required services with a minimum of delay. In addition the Contractor shall coordinate activities to avoid the necessity of removing and replacing construction to accommodate inspections and tests.
1. The Contractor is responsible for communicating to the Project Manager/Inspector the scheduling times for inspections, tests, taking samples and similar activities.
- E. Payment for Testing Laboratory Services:
1. Unless otherwise specified, FORA will pay for tests and inspections performed by Testing Laboratory, as specified in individual product Sections of the Specifications. Overtime costs due to scheduling for the convenience of the Contractor or to make up for Work behind schedule shall be deducted by Change Order from Contract Sum.
 2. When tests and inspections are required on an overtime basis, initial payment will be made by FORA. All costs for overtime testing and inspections shall be deducted by Change Order from Contract Sum.
 3. Unless otherwise specified, Contractor shall be back-charged for mileage and travel time for inspection services requiring more than 60 miles from Project site to test products purchased by Contractor.
 - a. Testing laboratory shall forward all billings and records of such costs to FORA Construction Manager for approval.
 - b. Such costs, if determined by FORA Construction Manager to be attributable to the Contractor under this provision, shall be deducted by Change Order from Contract Sum.
 4. Contractor shall pay all costs for repeated observations, reinspection or retesting by Testing Laboratory due to non-conforming Work. Costs shall be deducted by Change Order from Contract Sum.
 5. Additional Tests, Inspections and Related Services: Contractor shall be charged costs for additional tests, inspections and related services, due to the following. Such costs shall be deducted by Change Order from Contract Sum.
 - a. Work is not ready to inspect when inspectors arrive.
 - b. Failure to properly schedule or notify testing and inspection agency or authorities having jurisdiction.
 - c. Changes in sources, lots or suppliers of products after original tests or inspections.
 - d. Changes in means methods, techniques, sequences and procedures of construction that necessitate additional testing, inspection and related services.
 - e. Changes in mix designs for concrete and mortar after review and acceptance of submitted mix design.
 - f. Multiple off-site fabrication sites.
 - g. Fabrication and installation errors.
 - h. Inefficient, sporadic, or poorly organized manufacturing that causes additional testing costs to be incurred.

- F. Segregation in Billing of Overtime Services: Billings for overtime services shall have straight time and overtime costs segregated and shall have substantiation by detailed explanations justifying necessity of services on overtime basis.
- G. Obligation to Perform Work According to Contract Documents: Employment of Testing Laboratory shall in no way relieve Contractor of obligation to perform Work in accordance with requirements of Contract Documents and applicable Codes.
- H. Limits on Testing Laboratory's Authority:
 - 1. Testing Laboratory may not release, revoke, alter, or enlarge on requirements of Contract Documents.
 - 2. Testing Laboratory may not approve or accept any portion of the Work.
 - 3. Testing Laboratory may not assume any duties of Contractor.
 - 4. Testing Laboratory shall have no authority to stop Work.
- I. Contractor's Responsibilities to Testing Laboratory: Contractor shall make the Work in all stages of progress available for personal and continuous observation by the Testing Laboratory.
 - 1. Testing Laboratory shall have free access to any and all parts of the Work at all times.
 - 2. Contractor shall provide the Testing Laboratory with reasonable facilities for Testing Laboratory to obtain such information as Testing Laboratory determines is necessary for Testing Laboratory to be kept fully informed of the progress and manner of performance of the Work and character of products, according to Testing Laboratory's duties and responsibilities.
 - 3. Observation and inspection of the Work by Testing Laboratory shall not relieve Contractor from any obligation to fulfill the requirements of the Contract.
- J. Retesting: When materials tested fall to meet requirements herein specified, they shall be promptly corrected or removed and replaced and retested in a manner required by FORA Certified Industrial Hygienist or FORA Construction Manager. Costs involved in retesting shall be deducted by Change Order from Contract Sum.

1.05 TESTS AND INSPECTIONS

- A. Tests and Inspections, General: All construction work shall be subject to inspection by the Trustees and the Architect and all such construction or work shall remain accessible and exposed for inspection purposes until approved by FORA.
 - 1. FORA Construction Manager or FORA Certified Industrial Hygienist will provide project personnel, including inspectors, to be available at the project site.
 - 2. Approval as a result of an inspection shall not be construed to be an approval of a violation of the provisions of the building code or of other ordinances of the jurisdiction, including plans and specifications. Inspections presuming to give authority to violate or cancel the provisions of code, or of plans and specifications shall not be valid.
 - 3. It shall be the duty of the Contractor to cause the work to remain accessible and exposed for inspection purposes. Neither the Inspector nor the Trustees or Architect shall be liable for expense entailed in the removal or replacement of any material required to allow inspection.

- B. Inspection Requests: It shall be the duty of the Contractor doing the work to notify the Inspector that such work is ready for inspection. FORA requires that such work is ready for inspection. FORA requires that every request for inspection be filed at least two working days before such inspection is desired. Such requests shall be in writing.
- C. Approval Required: Work shall not be done beyond the point indicated in each successive inspection without first obtaining the approval of the Inspector. The Inspector, upon notification, shall make the requested inspections and shall either indicate in writing that portion of the construction is satisfactory as completed, or shall notify the Contractor that same fails to comply with plans and specifications. Any portions of Work that do not comply shall be corrected by the Contractor, and such portion shall not be covered or concealed until authorized by the Inspector.
 - 1. There shall be a final inspection and approval of all buildings and structures when completed and ready for occupancy and use.
- D. Inspection Coordination: Contractor shall provide, on a weekly basis, an anticipated Inspection Requirements Schedule, coordinated with the three-week look ahead schedule, showing the anticipated inspection needs for the following three weeks to facilitate appropriate campus coordination and interface as well as mobilization of required inspection staffing.
- E. Required Inspections:
 - 1. The Contractor shall be responsible for reviewing all of the Contract Documents for all inspection requirements.

1.06 SUBMITTALS

- A. Reports: FORA's independent testing agency shall submit a certified written report of each inspection, test or similar service, to FORA Construction Manager (two copies), FORA, and the Contractor (two copies).
- B. Report Data: Written reports of each inspection, test or similar service shall include, but not be limited to:
 - Date of issue
 - Project title and number
 - Name, address and telephone number of testing agency
 - Dates and locations of samples and tests or inspections
 - Names of individuals making the inspection or test
 - Designation of the Work and test method
 - Identification of product and Specification Section
 - Complete inspection or test data
 - Test results and an interpretation of test results
 - Ambient conditions at the time of sample-taking and testing
 - Comments or professional opinion as to whether inspected or tested
 - Work complies with Contract Document requirements
 - Name and signature of laboratory inspector
 - Recommendations on retesting.

1.07 SCHEDULES FOR TESTING

- C. Testing and Inspection Schedule: After discussion with FORA Construction Manager and Testing Laboratory in advance of performance of testing and inspection services, Contractor shall determine dates and times necessary for Testing Laboratory to schedule performance of required tests and inspections and determine due dates for issuance of reports.
- D. Revising Testing and Inspection Schedule: When changes of the construction schedule are necessary during construction, coordinate all such changes of schedule with the testing laboratory as required.
- E. Adherence to Testing and Inspection Schedule: When the Testing Laboratory is ready to test according to the determined schedule but is prevented from testing or taking specimens due to incompleteness of the work, all extra costs for testing attributed to the delay may be back-charged to the Contractor and shall not be borne by the FORA.

1.08 CONTRACTOR'S RESPONSIBILITIES

- A. Contractor's Responsibilities for Inspections and Tests:
 - 1. Notify FORA Construction Manager or FORA Certified Industrial Hygienist and Testing Laboratory two working days in advance of expected time for operations requiring inspection and testing services.
 - 2. Deliver to Testing Laboratory or designated location, adequate samples of materials proposed to be used which require advance testing, together with proposed mix designs.
 - 3. Cooperate with FORA Construction Manager, Testing Laboratory, Project Inspector, and FORA's consultants. Provide access to Work areas and off-site fabrication and assembly locations, including during weekends and after normal work hours.
 - 4. Provide incidental labor and facilities to provide safe access to Work to be inspected and tested, to obtain and handle samples at the Work site or at source of products to be tested, and to store and cure test samples.
 - 5. Provide at least 15 days in advance of first inspection or test of each type, a schedule of tests or inspections indicating types of tests or inspections and their scheduled dates.
 - 6. Provide two working days notice to FORA Construction Manager, and, as applicable, responsible design consultant, of each test and inspection.

1.09 INSPECTIONS TESTS BY OTHERS

- A. Inspections by Others: Refer to Section 01 45 00 - Quality Control.
- B. Tests by Others: Refer to Section 01 45 00 - Quality Control.

PART 2 – PRODUCTS (NOT USED)

PART 3 - EXECUTION

3.01 REPAIR AND PROTECTION

- A. Repair and Protection: Upon completion of inspection, testing, sample-taking and similar services, repair damaged construction and restore substrates and finishes to eliminate deficiencies, including deficiencies in visual qualities of exposed finishes. Comply with Contract Document requirements for "Cutting and Patching."
1. Protect construction exposed by or for quality control service activities, and protect repaired construction.
 2. Repair and protection is the Contractor's responsibility, regardless of the assignment of responsibility for inspection, testing or similar services.

END OF SECTION 01 45 80

S201-ITB1, Volume 2 - SECTION 01 51 00 – TEMPORARY UTILITIES

PART 1 - GENERAL

1.01 RELATED DOCUMENTS

- A. Construction Drawings, Technical Specifications, Addenda, and Contact Agreement, including any Addenda, including other Division 1 Specification Sections, apply to this Section.

1.02 SECTION INCLUDES

- B. Temporary utilities and services, including:
 - 1. Heating and cooling during construction
 - 2. Ventilation during construction
 - 3. Temporary water service
 - 4. Temporary sanitary facilities
 - 5. Temporary power and lighting
 - 6. Construction telephone service.
- C. Removal of temporary utilities.

1.03 RELATED SECTIONS

- D. Section 01 11 00 - Summary of the Work

1.1 SUBMITTALS

- A. Temporary Utilities: Submit reports of tests, inspections, applicable meter readings and similar procedures performed on temporary utilities.

1.04 TEMPORARY UTILITIES AND SERVICES

- B. Temporary Utilities and Services, General: All utilities and other services necessary for proper performance of the Work shall be provided by Contractor, unless specifically noted otherwise. Temporary utilities and services shall conform to all applicable requirements of authorities having jurisdiction and serving utility companies and agencies, including the following:
 - 1. Requirements of authorities having jurisdiction, including:
 - a. Cal OSHA
 - b. California Building Code (CBC) requirements
 - c. Health and safety regulations
 - d. Utility agency and company regulations
 - d. Police, Fire Department and Rescue Squad rules

- e. Environmental protection regulations
- 2. Standards:
 - a. NFPA Document 241 - Building Construction and Demolition Activities.
 - b. ANSI A10 Series - Safety Requirements for Construction and Demolition.
 - c. NECA Electrical Design Library - Temporary Electrical Facilities.
 - d. Electrical Service: Comply with NEMA, NECA and UL standards and regulations for temporary electric service. Install service in compliance with California Electrical Code (CEC).
- C. Inspections: Arrange for authorities having jurisdiction to inspect and test each temporary utility before use. Obtain required certifications and permits.
- D. Temporary Connections and Fees: Contractor shall arrange for services and pay all fees and service charges for temporary power, water, sewer, gas and other utility services necessary for the Work.
 - 1. Contractor shall apply for and obtain permits for temporary utilities, including permits for temporary generators, from authorities having jurisdiction.
 - 1. All costs for temporary connections, including fees charged by serving utilities, shall be included in Contract Sum.
- D. Use of Temporary Utilities: Enforce strict discipline in use of temporary utilities to conserve on consumption. Limit use of temporary utilities to essential and intended uses to minimize waste and abuse.

1.05 PROJECT CONDITIONS

- A. Conditions of Use: Keep temporary services and facilities clean and neat in appearance. Operate in a safe and efficient manner. Take necessary fire prevention measures. Do not overload facilities, or permit them to interfere with progress. Do not allow hazardous, dangerous, or unsanitary conditions, or public nuisances to develop or persist on the site.

1.06 TEMPORARY WATER SERVICE

- A. Water Service: Water may be taken from existing system with metering provided by Marina Coast Water District. Water may be taken in such quantities and at such times as they are available. Point of connection for water service shall be coordinated with the FORA Construction Manager and Marina Coast Water District. Use charges for temporary water facilities are not chargeable to the FORA or FORA's consultants and shall be included in the Contract Sum. Contractor shall furnish, install, and maintain all temporary supply connections, meters, piping, fittings, etc., as necessary for the Work. Before final acceptance, all temporary connections and piping installed by Contractor shall be removed in a manner approved by the FORA Construction Manager.
 - 1. Install necessary source protection and meter at the point of connection to water system.
 - 2. Drinking water shall be furnished by the Contractor.

3. Obtain approval from the FORA and the Federal (Naval Support Activity) Fire Department prior to using fire hydrants as a water supply. All water drawn from fire hydrants shall be metered by the Contractor.

1.07 TEMPORARY SANITARY FACILITIES

- B. Temporary Sanitary Facilities: Provide and maintain adequate temporary sanitary facilities and enclosures for use by construction personnel.
 2. Number of temporary toilets shall be suitable for number of workers.
 3. Provide wash-up sink with soap, towels and waste disposal.
- C. Use of Permanent Sanitary Facilities: Do not use permanent sanitary facilities.

1.08 TEMPORARY POWER AND LIGHTING

- A. Temporary Electric Power Service: Electricity shall be taken from the existing system as available. Coordinate the installation with the FORA Construction Manager, as applicable, to identify point of connection and metering location(s).
 1. Furnish, install, and maintain all necessary temporary electrical equipment, meter(s), connections, etc., as necessary for the Work. All temporary and permanent power used by the Contractor on this project shall be drawn and metered from no more than a maximum of 2 meters. Points of connection to the existing electrical system shall be coordinated with the FORA Construction Manager. Before final acceptance, all temporary equipment and connections installed by Contractor shall be removed in a manner approved by the FORA Construction Manager.
 2. Service connections shall be made by Contractor to the existing electrical distribution system. Provide meter, conduit and wires, drops, circuit breakers, and disconnect switches as required. Characteristics of current are limited to that existing and available; if current or other characteristics or quantity is required by Contractor, Contractor shall supply the power as necessary at no extra cost to the FORA.
 - a. Provide ground fault circuit interrupters and reset button with pilot light for plug-in connection of power hand tools. All extension cords shall be "hard-service" cords where exposed to traffic and abrasion.
 - b. Provide temporary lighting for Work in progress, inspection, protection, and security at the following minimum levels:
 - 1) General construction open floor area lighting; 1 – 200 watt lamp per each open 1,000 square feet to achieve uniform illumination.
 - 2) Corridors and similar traffic areas: 1 – 100 watt lamp per each 50 lineal feet.
 - 3) Stairways, ladder runs, and similar traffic areas: 1 – 75 watt lamp located to illuminate each landing and flight.
 3. At Contractor's own expense, Contractor shall repair and make good all damage to existing electrical facilities caused by Contractor's use, as requested and approved.
- B. Protection: Provide weatherproof enclosures for power and lighting components as necessary. Provide overcurrent and ground-fault circuit protection, branch wiring and

distribution boxes located to allow convenient and safe service about site of the Work. Provide flexible power cords as required.

- C. Service Disruptions: When necessary for energizing and de-energizing temporary electric power systems, minimize disruption of service to those served by public mains. Schedule transfers at times convenient to neighboring occupants.

1.09 CONSTRUCTION TELEPHONE SERVICE

- A. Construction Telephone Service: Provide telephone service to Contractor's field staff by means of cellular telephones, pagers and radio service, to enable communications between FORA Construction Manager and Contractor.
 - 1. Include voice message service and paging services.
 - 2. All costs of construction telephone, paging and radio services shall be included in Contract Sum.

PART 2 - PRODUCTS

2.01 MATERIALS AND EQUIPMENT

- A. Materials: Contractor shall provide new materials. If acceptable to the FORA Construction Manager, undamaged previously used materials in serviceable condition may be used. Provide materials that are suitable for the use intended. Their use and methods of installation shall not create unsafe conditions or violate requirements of applicable codes and standards.
- B. Equipment: Contractor shall provide new equipment; or, if acceptable to the Trustees, Contractor may provide undamaged, previously used equipment in serviceable condition. Provide equipment that is suitable for use intended.

PART 3 - EXECUTION

3.01 TEMPORARY UTILITIES INSTALLATION

- A. Temporary Utilities Installation, General: Contractor shall engage the appropriate local utility company or personnel to install temporary service or connect to existing service.
 - 1. Use Charges: Cost or use charges for temporary facilities are the Contractor's responsibility.
 - 2. Allowance for Utilities Charges: When Contract includes an allowance for metering of utility services, whether through temporary or permanent facilities, unused amount shall be returned to the FORA by deductive change order.
- B. Temporary Electric Power Service: The Contractor must arrange and pay for electric service through the local utility or furnish his own portable power. All permanent power used by the Contractor prior to Occupancy by the FORA shall be metered and paid for by the Contractor.
- C. Temporary Telephones: Contractor shall have telephone facility available at its business office for the duration of contract where the Contractor and its superintendent may be contacted.
- D. Temporary Fire Protection: Until fire protection needs are supplied by permanent facilities,

Contractor shall install and maintain temporary fire protection facilities of the types needed to protect against reasonably predictable and controllable fire losses. Contractor shall comply with NFPA 10 "Standard for Portable Fire Extinguishers," and NFPA 241 "Standard for Safeguarding Construction, Alterations and Demolition Operations." Contractor shall:

1. Locate fire extinguishers where convenient and effective for their intended purpose, but not less than one extinguisher on each floor at or near each usable stairwell.
 2. Store combustible materials in containers in fire-safe locations.
 3. Maintain unobstructed access to fire extinguishers, fire hydrants, temporary fire protection facilities, stairways and other access routes for fighting fires. Prohibit smoking in hazardous fire exposure areas.
 4. Provide supervision of welding operations, combustion type temporary heating units, and similar sources of fire ignition.
- E. Maintenance of Temporary Utilities and Services: Contractor shall maintain temporary utilities and services in good operating condition until removal. Contractor shall protect from utilities and services from environmental and physical damage.

3.02 3TERMINATION AND REMOVAL OF TEMPORARY UTILITIES AND SERVICES

- F. Termination and Removal of Temporary Utilities and Services: Unless the FORA Construction Manager requires that it be maintained longer, Contractor shall remove each temporary facility when the need has ended.
- G. Removal of Temporary Underground Utilities and Restoration: Remove temporary underground utility installations to a minimum depth of two-feet below utility services. Contractor shall:
1. Backfill, compact and regrade site as necessary to restore areas or to prepare for indicated paving and landscaping.
 2. Restore paving damaged by temporary utilities. Refer to requirements specified in Section 01 73 20 - Cutting and Patching Requirements.
- H. Cleaning and Repairs: Contractor shall clean exposed surfaces and repair damage caused by installation and use of temporary utilities and services. Where determined by FORA Construction Manager that repair of damage is unsatisfactory, Work, Contractor shall replace construction with matching finishes. Refer to requirements specified in Section 01 73 20 - Cutting and Patching Requirements.

END OF SECTION 01 51 00

S201-ITB1, Volume 2 - SECTION 01 52 00 – CONSTRUCTION FACILITIES

PART 1 - GENERAL

1.01 RELATED DOCUMENTS

- A. Construction Drawings, Technical Specifications, Addenda, and Contact Agreement, including any Addenda, including other Division 1 Specification Sections, apply to this Section.

1.02 SECTION INCLUDES

- A. Field offices and sheds.
- B. Removal of construction facilities.

1.03 1.1 RELATED SECTIONS

- A. Section 01 11 00 - Summary of the Work
- B. Section 01 51 00 - Temporary Utilities
- C. Section 01 52 50 - Construction Staging Areas
- D. Section 01 74 00 - Cleaning Requirements

1.04 MAINTENANCE OF CONSTRUCTION FACILITIES CONTROLS

- A. Maintenance: Contractor shall use all means necessary to maintain construction facilities in proper and safe condition throughout progress of the Work.
- B. Replacement: In the event of loss or damage, Contractor shall promptly restore temporary construction facilities by repair or replacement at no change in the Contract Sum or Contract Time.

1.05 CONTRACTOR'S FIELD OFFICES AND SHEDS

- A. Contractor's Field Office: Contractor shall provide a mobile field office of weather-tight construction, with lighting, power, ventilation, heating and cooling to house Contractor. Unless otherwise indicated on the Drawings, Contractor shall locate field office at in staging area described in Section 01 52 50 - Construction Staging Areas. Contractor shall comply with FORA's requirements transmitted through FORA Construction Manager.
 - 1. Contractor shall provide temporary utilities to serve Contractor's field office. Refer to Section 01 51 00 - Temporary Utilities.
 - 2. Contractor's Field Office shall present neat, business-like appearance at all times, internally and externally.
 - 3. Contractor shall ensure that neither Contractor's Field Office nor other jobsite facilities are used for living quarters.
- B. Storage Sheds for Tools, Materials, and Equipment: Contractor shall provide weather-tight sheds, all with the following:

1. heat and ventilation appropriate for storage of products requiring controlled conditions,
 2. adequate space for organized storage and access, and
 3. lighting for inspection of stored materials.
- C. Layout of Field Offices and Sheds: Within five working days of the Notice to Proceed, Contractor shall submit to FORA Construction Manager a proposed layout for field offices, sheds and storage areas. FORA Construction Manager will review and respond within five working days with comments and directions. Contractor shall comply with directions of FORA Construction Manager.

PART 2 - PRODUCTS (NOT USED)

PART 3 - EXECUTION

3.01 INSTALLATION OF CONSTRUCTION FACILITIES

- A. Layout of Field Offices and Sheds: Within five working days of the Notice to Proceed, Contractor shall submit to FORA Construction Manager a proposed layout for field offices, sheds and storage areas. FORA Construction Manager will review and respond within five working days with comments and directions. Contractor shall comply with directions of FORA Construction Manager.
1. Coordinate with requirements specified in Section 01 52 50 - Construction Staging Areas.
 2. Coordinate installation of construction fencing as specified in Section 01 56 00 - Temporary Barriers and Enclosures.

3.02 REMOVAL OF CONSTRUCTION FACILITIES

- B. Removal of Construction Facilities: Unless otherwise mutually agreed by FORA Construction Manager and Contractor, remove temporary materials, equipment, services, and construction prior to Contract Completion review.
3. Coordinate removal with requirements specified in Section 01 51 00 - Temporary Utilities, Section 01 52 00 - Construction Facilities, Section 01 55 00 - Vehicular Access and Parking and Section 01 56 00 - Temporary Barriers and Enclosures.
 4. Completely remove in-ground construction facilities to minimum depth of two feet. Backfill, compact and regrade site as necessary to restore areas or to prepare for indicated paving and landscaping.
- C. Cleaning and Repairs: Clean and repair damage caused by installation or use of temporary construction facilities on public and private rights-of-way.

END OF SECTION 01 52 00

S201-ITB1, Volume 2 - SECTION 01 52 50 – CONSTRUCTION STAGING AREAS

PART 1 - GENERAL

1.01 RELATED DOCUMENTS

- A. Construction Drawings, Technical Specifications, Addenda, and Contact Agreement, including any Addenda, including other Division 1 Specification Sections, apply to this Section.

1.02 SECTION INCLUDES

- B. Contractor Staging Area requirements.

1.03 RELATED SECTIONS

- C. Section 01 11 00 - Summary of the Work
- B. Section 01 54 10 - Security
- C. Section 01 55 00 - Vehicular Access and Parking
- D. Section 01 56 00 - Temporary Barriers and Enclosures
- E. Section 01 57 00 - Temporary Controls

1.04 SUBMITTALS

- D. Shop Drawings: Prior to site mobilization, Contractor shall prepare and submit for review by FORA Construction Manager a site plan indicating detailed layout of Contractor Staging Area, including:
 - 1. Temporary utilities
 - 2. Temporary fencing and gates
 - 3. Temporary offices and sheds
 - 4. Construction aids
 - 5. Vehicular accessways and on-site parking
 - 6. Temporary barriers and enclosures
 - 7. Storm water pollution prevention measures

PART 2 – PRODUCTS (NOT USED)

PART 3 - EXECUTION

3.01 CONTRACTOR STAGING AREA REQUIREMENTS

- A. Contractor Staging Areas: Contractor Staging Areas shall be contained within the Limits of Work as noted on the Drawings. .
 - 8. Contractor shall use only site areas designated specifically the FORA Construction Manager as Contractor Staging Area for the Project.
 - 9. Contractor Staging Area for the Project shall be clearly indicated. Contractor shall remove equipment placed or located outside of areas designated for Contractor Staging Area to within Contractor Staging Area at no change in Contract Time and Contract Sum.
 - 10. Contractor shall keep access to Contractor Staging Areas and other construction accessways and thoroughfares clear at all times. Contractor shall provide traffic and parking control signage acceptable to FORA Construction Manager.
- B. Cleanliness: Contractor shall keep Contractor Staging Area clear of trash and debris and in neat order. Contractor shall be responsible for cleanliness and order of assigned Contractor Staging Areas, as acceptable to FORA Construction Manager.

3.02 REMOVAL OF CONSTRUCTION FACILITIES AND TEMPORARY CONTROLS

- A. Removal of Construction Facilities and Temporary Controls: Unless otherwise mutually agreed by FORA Construction Manager and Contractor, Contractor shall remove temporary materials, equipment, services, and construction prior to Contract Completion review. Contractor shall coordinate removal with requirements specified in Section 01 51 00 - Temporary Utilities, Section 01 52 00 - Construction Facilities, Section 01 55 00 - Vehicular Access and Parking and Section 01 56 00 - Temporary Barriers and Enclosures.
- B. Cleaning and Repairs: Contractor shall clean and repair damage caused by installation or use of temporary facilities on public and private rights-of-way.
- C. Removal of Temporary Utilities and Restoration: Contractor shall remove temporary underground utility installations to a depth of two feet. Backfill, compact and regrade site as necessary to restore areas or to prepare for indicated paving and landscaping.

END OF SECTION 01 52 50

S201-ITB1, Volume 2 - SECTION 01 54 00 – CONSTRUCTION AIDS

PART 1 - GENERAL

1.01 RELATED DOCUMENTS

- A. Construction Drawings, Technical Specifications, Addenda, and Contact Agreement, including any Addenda, including other Division 1 Specification Sections, apply to this Section.

1.02 SECTION INCLUDES

- A. Construction aids, including:
 - 1. Temporary lifts and hoists
 - 2. Debris chutes
 - 3. Temporary stairs
 - 4. Scaffolding

1.03 RELATED SECTIONS

- A. Section 01 11 00 - Summary of the Work
- B. Section 01 56 00 - Temporary Barriers and Enclosures

1.04 CODES AND REGULATIONS

- A. Safety Regulations: Contractor shall comply with requirements of all applicable Federal, State and local safety rules and regulations. Contractor shall be solely responsible for jobsite safety.

1.05 TEMPORARY LIFTS AND HOISTS

- A. Temporary Lifts and Hoists: Contractor shall provide facilities for hoisting materials and personnel. Mobile lifts and truck cranes and similar devices used for hoisting materials are considered "tools and equipment" and not temporary facilities.

1.06 DEBRIS CHUTES

- A. Debris Chutes: Contractor shall provide chutes as necessary for debris removal. Contractor shall:
 - 1. Construct debris chutes of substantial materials. Use cylindrical, laminated fiber forms (Sonotube or equal) to minimize noise of debris removal.
 - 2. Provide controls at debris chutes to minimize spread of dust and debris.
 - 3. Limit use of debris chutes to times to minimize disruption of activities in adjacent spaces.

1.07 TEMPORARY STAIRS AND SCAFFOLDING

- B. Temporary Stairs: Until permanent stairs are available, Contractor shall provide temporary stairs where ladders are not adequate. Contractor shall cover finished, permanent stairs with protective covering of plywood or similar material so finishes will be undamaged at time of Contract Completion review.
- B. Scaffolding: Contractor shall provide scaffolding as necessary for access and proper performance of the Work. Design and installation of scaffolding shall be solely Contractor's responsibility.

PART 2 – PRODUCTS (NOT USED)

PART 3 - EXECUTION

3.01. MAINTENANCE OF CONSTRUCTION AIDS

- A. Maintenance: Contractor shall use all means necessary to maintain construction aids in proper and safe condition throughout progress of the Work.
- B. Replacement: In the event of loss or damage, Contractor shall promptly restore construction aids by repair or replacement at no change in the Contract Sum or Contract Time.

3.02. REMOVAL OF CONSTRUCTION AIDS

- C. Removal of Construction Aids: Unless otherwise mutually agreed by FORA Construction Manager and Contractor, Contractor shall remove construction aids prior to Contract Completion review. Contractor shall coordinate removal with requirements specified in Section 01 51 00 - Temporary Utilities, Section 01 52 00 - Construction Facilities, Section 01 55 00 - Vehicular Access and Parking, and Section 01 56 00 - Temporary Barriers and Enclosures.
- D. Cleaning and Repairs: Contractor shall clean and repair damage caused by installation or use of construction aids.

END OF SECTION 01 54 00

S201-ITB1, Volume 2 - SECTION 01 54 10 – SECURITY

PART 1 - GENERAL

1.01 RELATED DOCUMENTS

- A. Construction Drawings, Technical Specifications, Addenda, and Contract Agreement, including any Addenda, including other Division 1 Specification Sections, apply to this Section.

1.02 SECTION INCLUDES

- A. Contractor Security requirements.

1.03 RELATED SECTIONS

- B. Section 01 11 00 - Summary of the Work
- C. Section 01 56 00 - Temporary Barriers and Enclosures

1.04 SECURITY

- A. In addition to security requirements contained in the Article 2 of the Contract Agreement, Contractor shall adhere to the following requirements for security:
 - 1. Contractor shall protect the Work from theft, vandalism and unauthorized entry. Contractor shall have sole responsibility for job site security.
 - 2. Contractor shall maintain security throughout construction until the FORA Construction Manager acceptance.
 - 3. Provide Inspector Access. Contractor shall provide the FORA Construction Manager with keys necessary to gain access to locked areas of the Work. The FORA Construction Manager will be responsible for such keys and will return them to the Contractor upon acceptance of the project or area as complete.

1.05 ENTRY CONTROL

- D. Contractor shall restrict entrance of persons and vehicles into project site to authorized persons with proper identification and as required by Section 01 11 00 – Summary of the Work.
- E. Contractor shall allow building entrance only to authorized persons with proper identification.

PART 2 – PRODUCTS (NOT USED)

PART 3 – EXECUTION (NOT USED)

END OF SECTION 01 54 10

S201-ITB1, Volume 2 - SECTION 01 55 00 – Vehicular Access and Parking

PART 1 - GENERAL

1.01 RELATED DOCUMENT

- A. Construction Drawings, Technical Specifications, Addenda, and Contact Agreement, including any Addenda, including other Division 1 Specification Sections, apply to this Section.

1.02 SECTION INCLUDES

- B. Requirements for vehicular access to Work areas
- C. Requirements for construction parking

1.03 RELATED SECTIONS

- D. Section 01 11 00 - Summary of the Work
- E. Section 01 52 50 - Construction Staging Areas.
- F. Section 01 56 00 - Temporary Barriers and Enclosures
- G. Section 01 57 00 - Temporary Controls

1.04 PROTECTION OF EXISTING CONDITIONS

- H. Protection of Adjacent Facilities: Contractor shall restrict Work to limits indicated on the Drawings and as specified in Section 01 11 00 - Summary of the Work. Contractor shall protect existing, adjacent facilities from damage, including soiling and debris accumulation.

1.05 SITE ACCESS

- A. Site Access: Use of designated existing on-site streets and driveways for construction traffic is permitted. Contractor shall review access routes with FORA Construction Manager and comply with FORA Construction Manager directions.
 - 1. Contractor shall ensure that tracked vehicles shall not use paved areas.
 - 2. Contractor shall provide unimpeded access for emergency vehicles. Contractor shall maintain 20-foot width driveways with turning space between and around combustible materials.
 - 3. Contractor shall provide and maintain access to fire hydrants free of obstructions.
 - 4. Contractor shall clean and restore paving and other site features after construction use.
- B. Traffic Control:
 - 1. Contractor shall comply with all traffic regulations, including speed limits. Contractor shall pay all parking and traffic fines.

2. Blockage of site roadways and access to site parking lots and parking structures shall be only with approval of FORA Construction Manager. Contractor shall comply with City of Seaside restrictions on blocking roadways and parking areas.
3. Contractor shall employ trained and equipped flag persons to regulate traffic when construction operations or traffic encroach on vehicular and pedestrian traffic lanes.
4. Contractor shall provide signage, cones and other suitable devices to direct traffic. Contractor shall use flares and lights during hours of low visibility to delineate traffic lanes and to guide traffic.

1.06 TRAFFIC SIGNS AND SIGNALS

- C. Traffic Signs and Signals: Contractor shall provide temporary signs and signals as required by authorities having jurisdiction and in compliance with City of Seaside's requirements transmitted through FORA Construction Manager. Contractor shall relocate signs and signals as necessary during construction.

1.07 CONSTRUCTION PARKING

- D. Construction Parking:
 5. Contractor shall not park on public roadways unless approved by police and fire authorities.
 6. Contractor shall maintain clear access ways and parking for emergency vehicles, as required by police and fire authorities.
 7. Contractor shall provide on-site parking for construction purposes.

PART 2 – PRODUCTS (NOT USED)

PART 3 - EXECUTION

3.01. MAINTENANCE OF PARKING AND ACCESS ROADS

- A. Maintenance: Contractor shall maintain traffic and parking areas in a sound condition. Contractor shall repair breaks, potholes, low areas, standing water and other deficiencies, to maintain paving and drainage in original or specified condition.
- B. Cleaning of Roadways and Parking Areas: Contractor shall keep public and private rights-of-way and parking areas clear of construction-caused soiling, dust and debris, especially debris hazardous to vehicle tires. Contractor shall perform cleaning as frequently as necessary. Contractor shall coordinate with requirements specified in Section 01 57 00 - Temporary Controls.

END OF SECTION 01 55 00

S201-ITB1, Volume 2 - SECTION 01 56 00 – TEMPORARY BARRIERS AND ENCLOSURES

PART 1 - GENERAL

1.01 RELATED DOCUMENTS

- A. Construction Drawings, Technical Specifications, Addenda, and Contact Agreement, including any Addenda, including other Division 1 Specification Sections, apply to this Section.

1.02 SECTION INCLUDES

- B. Temporary construction barriers, enclosures and passageways.
 - 1. Dust and debris barriers.
 - 2. Security barriers.
 - 3. Temporary chain link fencing.
 - 4. Covered passageways.

1.03 RELATED SECTIONS

- C. Section 01 11 00 - Summary of the Work
- D. Section 01 51 00 – Temporary Utilities
- D. Section 01 52 50 - Construction Staging Areas
- F. Section 01 54 10 - Security
- G. Section 01 55 00 - Vehicular Access and Parking
- H. Section 01 56 80 - Tree and Plant Protection
- I. Section 01 57 00 - Temporary Controls

1.04 CODES AND REGULATIONS

- A. California Building Code (CBC): Comply with California Building Code (CBC) Chapter 33, Section 3303, Protection of Pedestrians During Construction or Demolition.
- B. Fire Regulations: Comply with requirements of fire authorities having jurisdiction, including California Fire Code (CFC) Article 87 during performance of the Work.
- C. Safety Regulations: Comply with requirements of all applicable Federal, State and local safety rules and regulations. Contractor shall be solely responsible for jobsite safety.
- D. Barricades and Barriers: As required by governing authorities having jurisdiction, provide substantial barriers, guardrails and enclosures around Work areas and adjacent to embankments and excavations for protection of workers and the public.

1.05 PROTECTION OF EXISTING CONDITIONS

- A. Protection of Adjacent Facilities: Contractor shall restrict Work to limits indicated on the Drawings and as specified in Section 01 11 00 - Summary of the Work: Protect existing, adjacent facilities from damage, including soiling and debris accumulation.
- B. Protection of Existing Fixtures and Equipment: As applicable, provide temporary enclosures, barriers and covers to protect existing fixtures and equipment remaining in Project area during construction.

1.06 MAINTENANCE OF CONSTRUCTION FACILITIES AND TEMPORARY CONTROLS

- C. Maintenance: Use all means necessary to maintain temporary barriers and enclosures in proper and safe condition throughout progress of the Work.
- D. Replacement: In the event of loss or damage, promptly restore temporary barriers and enclosures by repair or replacement at no change in the Contract Sum or Contract Time.

1.07 TEMPORARY BARRIERS, ENCLOSURES AND PASSAGEWAYS

- E. Temporary Barriers, General: Provide temporary fencing, barriers and guardrails as necessary to provide for public safety, to prevent unauthorized entry to construction areas and to protect existing facilities and adjacent properties from damage from construction operations.
 - 5. Refer to temporary fencing and phasing plan in the Drawings. Comply with requirements indicated.
 - 6. Note requirements for continued occupancy and use of existing buildings and site areas during construction.
 - 7. Comply with applicable requirements of California Building Code (CBC) and authorities having jurisdiction, including industrial safety regulations.
 - 8. Maintain unobstructed access to fire extinguishers, fire hydrants, temporary fire-protection facilities, stairways, and other access routes for firefighting.
 - 9. Paint temporary barriers and enclosures with appropriate colors, graphics, and warning signs to inform personnel and public of possible hazard.
 - 10. Where appropriate and necessary, provide warning lighting, including flashing red or amber lights.
- F. Temporary Chain-Link Fencing: Provide temporary portable chain-link fencing. See Section 01 52 50 - Staging Area for requirements for layout of fencing.
 - 1. Portable Chain-Link Fencing: Minimum 2-inches 11-gauge, galvanized steel, chain-link fabric fencing; minimum 8-feet high with galvanized steel pipe posts; minimum 2-3/8-inches OD line posts and 2-7/8-inches OD corner and pull posts, with 1-5/8-inches OD top and bottom rails.
 - a. Provide concrete or galvanized steel bases for supporting posts.
 - b. Provide protective barriers at bases to prevent tripping by pedestrians.

- C. Temporary Wood Fencing: Erect a structurally adequate, protective wood fencing in compliance with California Building Code (CBC) Chapter 33, Section 3303.7 - Pedestrian Protection. Wood fencing shall be provided as required by Table 33-A.
 - 1. Materials: As required by CBC Section 3303.7.
 - 2. Finishes: As acceptable to FORA Construction Manager. Fence where exposed to public view shall receive minimum of one coat wood primer and one coat semi-gloss paint, color(s) as directed by FORA Construction Manager.
- D. Barricades, Warning Signs and Lights, General: Comply with standards and code requirements for erection of structurally adequate barricades. Paint barricades with appropriate colors, graphics and warning signs to inform personnel and the public when protecting them against a hazard. Where appropriate and needed provide lighting, including flashing red or amber lights.
- E. Guard Rails: Provide guard rails along tops of embankments and excavations. Along public walkways and areas accessible by the public, adjoining excavations, provide guardrails in addition to fencing.
 - 1. Guardrails shall be substantially and durably constructed of lumber, firmly anchored by posts embedded in concrete, and complying with Code requirements for temporary barriers.
 - 2. Guardrails shall comply with dimensional requirements and accommodate loads as prescribed by California Building Code (CBC) for permanent guardrails.
- F. Security Closures and Lockup: Provide substantial temporary closures of openings in exterior surfaces and interior areas as appropriate to prevent unauthorized entrance, vandalism, theft and similar violations of security.
 - 1. Storage: Where materials and equipment must be stored, and are of value or attractive for theft, provide a secure lockup. Enforce discipline in connection with the installation and release of material to minimize the opportunity for theft and vandalism.
- G. Temporary Access, Passage and Exit Ways: Construct temporary stairs, ramps, and covered walkways, with related doors, gates, closures, guardrails, handrails, lighting and protective devices, to maintain access and exit ways to existing facilities to remain operational.
 - 1. Design and location of temporary construction shall be by Contractor, subject to review by FORA Construction Manager and authorities having jurisdiction.
 - 2. Provide temporary lighting, illuminated interior exit signage, non-illuminated directional and instructional signage, and temporary security alarms for temporary exits and exit passageways.
 - 3. Temporary measures shall suit and connect to existing building systems, and shall be approved by FORA Construction Manager and authorities having jurisdiction.

1.08 REMOVAL OF TEMPORARY BARRIERS AND ENCLOSURES

- G. Removal of Temporary Barriers and Enclosures: Unless otherwise mutually agreed by FORA Construction Manager and Contractor, remove temporary materials, equipment, services, and construction prior to Contract Completion review. Coordinate removal with requirements specified in Section 01 51 00 - Temporary Utilities, Section 01 52 00 -

Construction Facilities, Section 01 55 00 - Vehicular Access and Parking and Section 01 56 0 - Temporary Barriers and Enclosures.

- H. Cleaning and Repairs: Clean and repair damage, soiling and marring caused by installation or use of temporary barriers and enclosures.

PART 2 – PRODUCTS (NOT USED)

PART 3– PRODUCTS (NOT USED)

END OF SECTION 01 56 00

S201-ITB2, Volume 2 - SECTION 01 56 80 – TREE AND PLANT PROTECTION

PART 1 - GENERAL

1.01 RELATED DOCUMENT

- A. Construction Drawings, Technical Specifications, Addenda, and Contact Agreement, including any Addenda, including other Division 1 Specification Sections, apply to this Section.

1.02 SECTION INCLUDES

- A. Requirements for protection of existing landscape plant materials, including Trees, shrubs and ground covers. Contractor shall preserve, protect, and prune as necessary existing trees and shrubs, and other vegetation indicated to remain.

1.03 RELATED SECTIONS

- A. Section 01 56 00 – Temporary Barriers and Enclosures
- B. Section 01 57 00 – Temporary Controls

1.04 WORK DESCRIPTION

- A. Protection: All trees and plant materials to remain on site shall be protected from construction activities. Preserve, protect, and prune as necessary existing trees and shrubs and other vegetation indicated to remain.
- B. Maintenance: Until Contract closeout, Contractor shall irrigate, fertilize, prune and clean as necessary to maintain all existing trees, shrubs and ground covers in healthy condition, within and adjacent to Project area.

1.05 QUALITY ASSURANCE

- C. Arborist: Contractor shall engage and pay an Arborist who will be responsible for supervising implementation of tree and plant protection measures specified in this Section.
 - 1. Arborist shall be subject to acceptance by FORA Construction Manager.
 - 2. Arborist registered by the American Society of Consulting Arborists.
 - 3. Submit evidence contract with acceptable Certified Arborist prior to commencing site mobilization activities.

PART 2 - PRODUCTS

2.01 BARRIERS

- A. Barriers: As specified in Section 01 56 00 - Temporary Barriers and Enclosures.

PART 3 - EXECUTION

3.01 PROTECTION

- A. Protection: Prior to construction activities, especially demolition and excavation, on the site, Contractor shall submit to FORA Construction Manager evidence of a contract with an Arborist who shall be responsible for supervising implementation of the following tree protection measures.
1. Protect existing trees, shrubs and ground covers from stockpiling, material storage including soil, vehicle parking and driving within the tree drip line. Restrict foot traffic to prevent excessive compacting of soil over root systems.
 2. Protect root systems of existing trees, shrubs, and ground covers from damage due to chemically injurious materials in solution caused by runoff and spillage during mixing, placement of construction materials, and drainage from stored materials.
 3. Protect root system from flooding, erosion, excessive wetting and drying resulting from de-watering and other operations.
 4. Above-ground surface runoff shall not be directed into the tree canopy area from adjacent areas. Ensure that sidewalks or other construction do not trap water near the tree. Coordinate with requirements specified in Section 01 57 00 - Temporary Controls.
 5. Protect existing trees from unnecessary cutting, breaking and skinning of roots and branches, skinning and bruising of bark.
 6. Use no soil sterilants under pavement near existing trees.
 7. Do not allow fires under and adjacent to existing trees or plants.

3.02 PRUNING

- A. Pruning: Arborist shall direct removal of branches from trees and large shrubs and correctional pruning and cabling of specified trees which are to remain in Project, if required to clear new construction and where indicated, and to direct tree root pruning and relocation Work. Procedure for each tree may vary and shall be subject to approval by Arborist and FORA Construction Manager prior to commencing Work.
8. Where indicated by FORA Construction Manager, extend pruning operation to restore natural shape of entire tree using only Western Chapter, ISA Pruning Standards.
 9. Cut branches and roots with sharp pruning instruments. Do not break, chop, or mutilate.
 10. Pruning of existing trees shall be limited to removal of all dead wood 1/2-inch or greater in size and removal of vines and sucker growth. Tree cavities existing on all oak trees shall be cleaned of wood rot.
 11. Tree limbs shall be trimmed or removed only under direction of skilled and experienced supervisor, according to directions of Arborist.

3.03 EXCAVATION AROUND TREES

- A. Excavation Around Trees: Excavate within drip lines of trees only where indicated.
 - 1. Where trenching for utilities is required within drip lines, tunnel under and around roots of 2-1/2 inches diameter or larger by hand digging. Do not cut main lateral roots that are two inches or larger. Cut smaller roots that are smaller than two inches that interfere with installation of new Work. Use sharp, approved pruning tools. Pipes shall be routed into alternate locations to avoid conflict with remaining tree roots.
 - 2. Where excavating for new construction is required within drip lines of trees, hand excavate to minimize damage to root systems. Use narrow tine spading forks and comb soil to expose roots. Relocate roots in backfill areas wherever possible. If large, main lateral roots are encountered, expose beyond excavation limits as required to bend and relocate without breaking.
 - 3. If encountered immediately adjacent to location of new construction and relocation is not practical, cut roots approximately six inches back from new construction. Treat and cover cut ends as directed by Certified Arborist.
 - 4. Do not allow exposed roots to dry out before permanent backfill is placed. Provide temporary earth cover, pack with wet peat moss or four layers of wet untreated burlap and temporarily support and protect roots from damage until permanently relocated and covered with backfill. Irrigate to eliminate voids and air pockets.
- B. Pruning: Thin branching structure in accordance with Western Chapter, ISA Pruning Standards to balance loss to root system caused by damage or cutting of root system. Thinning shall not exceed 30 percent of existing branching structure.

3.04 GRADING AND FILLING AROUND TREES

- A. Grading and Filling Around Trees: Maintain existing grade within drip line of trees unless otherwise indicated.
 - 1. Grade changes shall be limited to six inches of cut or fill from original grade and shall be accomplished by hand.
 - 2. Under all trees there shall be no grade change under at least the inner 50% of the tree canopy.
- B. Lowering Grades Around Trees: Where existing grade is above new finish grade shown around trees, carefully hand excavate within drip line to new grade. Cut roots exposed by excavation to approximately three inches below elevation of new finish grade.
- C. Raising Grades Around Trees: Permitted only as acceptable to Certified Arborist and FORA Construction Manager.
- D. Other Changes: If building pads or foundations are indicated to be constructed within Project area or if existing landscaping requires alteration due addition of fill or reduced by excavation, notify FORA Construction Manager for directions prior to starting Work. Measures as directed by FORA Construction Manager, such as addition of small retaining walls or subgrade aeration lines, may be required to mitigate construction procedures affecting tree.

3.05 REPAIR AND REMOVAL OF TREES

- A. Repair and Removal of Trees: Remove trees that may impede building removal work within 25 foot perimeter of building to be removed. Arborist or FORA Construction Manager will determine whether additional trees shall be restored or removed. Treat and restore trees damaged by construction operations in a manner acceptable to FORA Construction Manager. Perform restoration and pruning promptly after damage occurs to prevent progressive deterioration of damaged trees. If trees cannot be restored, equitable adjustment to Contract Sum shall be made to compensate FORA for loss, in accordance with the Contract General Conditions.
1. Remove dead and damaged trees that are determined by Arborist to be incapable of restoration to normal growth pattern.
 2. Contractor shall be liable for all damage and necessary restoration actions to existing trees, including trunk, branches, or roots. Restoration shall be performed under direction of Certified Arborist.

END OF SECTION 01 56 80

S201-ITB1, Volume 2 - SECTION 01 57 00 – TEMPORARY CONTROLS

PART 1 - GENERAL

1.01 RELATED DOCUMENTS

- A. Construction Drawings, Technical Specifications, Addenda, and Contact Agreement, including any Addenda, including other Division 1 Specification Sections, apply to this Section.

1.02 SECTION INCLUDES

- B. Protection of existing conditions, including video record of existing conditions.
- C. Life safety and fire protection.
- D. Security.
- E. Runoff control.

1.03 RELATED SECTIONS

- F. Section 01 11 00 - Summary of the Work
- B. Section 01 55 00 - Vehicular Access and Parking
- C. Section 01 56 00 - Temporary Barriers and Enclosures

1.04 CODES AND REGULATIONS

- G. Fire Regulations: Comply with requirements of fire authorities having jurisdiction, including California Fire Code (CFC) Article 87 during performance of the Work.
- H. Safety Regulations: Contractor shall be solely responsible for jobsite safety. Minimum requirements shall include the following.
 - 1. Comply with requirements of all applicable Federal, State and local safety rules and regulations.
- I. Barricades and Barriers: As required by authorities having jurisdiction, provide substantial barriers, guardrails and enclosures around Work areas and adjacent to embankments and excavations for protection of workers and the public. See Section 01 56 00 - Temporary Barriers and Controls for additional requirements.

1.05 PROTECTION OF EXISTING CONDITIONS

- J. Protection of Adjacent Facilities: Contractor shall restrict Work to limits indicated on the Drawings and as specified in Section 01 11 00 - Summary of the Work. Protect existing, adjacent facilities from damage, including soiling and debris accumulation.
- K. Video Record of Existing Conditions: Contractor shall produce video record of all existing conditions within and adjacent to Project area.

1. Video record shall be made on DVD with sound to record comments to identify locations and describe conditions.
2. FORA Construction Manager will accompany Contractor during recording of existing conditions but will not direct recording process.
3. Video shall record state of existing features, including but not limited to:
 - a. Paving.
 - b. Landscaping.
 - c. Building surfaces.
 - d. Utilities.
 - e. Lighting standards, fencing, signage and other site appurtenances.
4. Contractor shall retain one copy and deliver one copy of video record to FORA Construction Manager within seven calendar days after the video record was produced.
5. Video record shall be used to verify restoration of existing conditions after completion of construction activities.
6. Existing feature not recorded shall be restored as directed by FORA Construction Manager, including reconstruction and refinishing as determined necessary by FORA Construction Manager.

1.06 FIRE PROTECTION

- L. Fire Protection Responsibility: Protection of Project from fire shall be solely Contractor's responsibility.
- M. Fire Protection Provisions, General: Maintain, at a minimum, the Work in conditions to minimize fire hazards and provide adequate fire protection devices, such as suitable fire extinguishers, blankets, warning signs and storage containers.
 7. Store combustible materials in containers in fire-safe locations.
 8. Maintain unobstructed access to fire extinguishers, fire hydrants, temporary fire protection facilities, stairways and other access routes for fighting fires. Prohibit smoking in hazardous fire exposure areas.
 9. Provide supervision of welding operations, combustion type temporary heating units, and similar sources of fire ignition.
- N. Special Fire Protection Provisions: During hazardous construction activities, maintain adequate fire protection devices immediately available for use at the location of such activities.
- D. Fire Extinguishers for Protection During Construction: Comply with NFPA 10 and 241 for classification, extinguishing agent and size required by location and class of fire exposure.
 1. Provide hand carried, portable UL-rated, Class "A" fire extinguishers for temporary offices and similar spaces.
 2. In other locations, provide hand-carried, portable, UL-rated, Class "ABC" dry chemical extinguishers, or a combination of extinguishers of NFPA recommended classes for the exposures.

- E. Installation of Fire Extinguishers for Protection During Construction: Locate fire extinguishers in field offices, storage sheds, tool houses, other temporary buildings and throughout the Work site. Comply with directions of Fire Marshal having jurisdiction.
 - 1. In the area under construction, provide at least one fire extinguisher for each 5,000 square feet of building floor area.
 - 2. Locate fire extinguishers no greater than 100 feet travel distance apart.

1.07 SECURITY

- A. Security Responsibility: Security of the Project area shall be solely the Contractor's responsibility until completion of the Work.
- B. Security Provisions, General: Provide security program and facilities to protect Work from unauthorized entry, vandalism, and theft.
- C. Guard Service: At Contractor's discretion, employ guards to protect the site after working hours.

1.08 RUNOFF CONTROL

- A. Erosion and Sedimentation Control: Erosion and sedimentation control provisions shall meet or exceed minimum requirements of authorities having jurisdiction. When provisions are indicated on Drawings, they are minimum requirements. If no sedimentation control system is shown, then Contractor shall design and provide system to prevent siltation of adjacent property as required by authorities having jurisdiction. See Civil Drawings for additional requirements and details.
 - 1. Implement erosion and sedimentation control provisions prior to commencing site clearing, grading, backfilling and compacting or other construction activities which will expose soil to erosion and potential for sediment-laden runoff.
 - 2. Ensure that sediment-laden water does not enter drainage systems.
 - 3. Maintain erosion and sedimentation control provisions until Contract Completion review is completed for landscaping, or sooner if approved by authorities having jurisdiction.
 - 4. Implementation, maintenance, replacement and additions to erosion and sedimentation control provisions shall solely be the responsibility of the Contractor. As construction progresses and seasonal conditions dictate, more erosion and sedimentation controls may be required. If so, Contractor shall provide additional provisions over and above minimum requirements as necessary.
- B. Drainage: Grade site and other Work areas to drain.
 - 1. Provide temporary drainage ditches and diversion measures as necessary to protect construction.
 - 2. Provide erosion control measures as necessary and as required by authorities having jurisdiction. Comply with local water quality control requirements, as applicable.
- C. De-Watering: Maintain excavations free of water. Provide and operate pumping equipment as necessary.
 - 1. Removal of contaminated water from excavations, dewatering of contaminated

groundwater and discharging of contaminated soils via surface erosion is prohibited.

2. Dewatering of non-contaminated groundwater shall be performed only after Contractor obtains a National Pollutant Discharge Elimination System Permit from the State or Regional Water Quality Control Board having authority. Costs of such permit shall be included in the Contract Sum.
- D. Runoff Control: Storm water runoff and other waters may be encountered at various times during construction. Contractor, by signing the Agreement, acknowledges that risks arising from storm water runoff and other waters have been investigated and considered, and Contract Sum and Contract Time include all costs associated with runoff control.
1. It shall be responsibility of Contractor to protect Work from detrimental effects of all waters encountered.
 2. It shall be responsibility of Contractor to protect Work from detrimental effects of runoff.
 3. Should damage to the Work due to surface or other water occur prior to acceptance of the Work by FORA Construction Manager, Contractor shall repair or replace Work at no change in Contract Time or Contract Sum.
- E. National Pollutant Discharge Elimination System: Contractor shall comply with requirements of environmental protection and storm drainage authorities having jurisdiction.
1. Project Area and other areas affected by Work under the Contract shall be maintained in such condition that anticipated storm runoff does not carry wastes and other pollutants off the site.
 2. Discharges of material other than storm water will be allowed only when necessary for performance of the Work and where such discharge does not cause the following:
 - a. Cause or contribute to a violation of applicable water quality standard.
 - b. Cause or threaten to cause pollution, contamination or nuisance, as determined by Authorities having jurisdiction. Potential pollutants include but are not limited to:
 - 1) Solid or liquid chemical spills.
 - 2) Wastes from paints, stains, sealants, adhesives, limes, pesticides, herbicides, wood preservatives and solvents.
 - 3) Asbestos fibers, paint flakes or fragments of plaster and drywall.
 - 4) Fuels, lubricants, hydraulic fluids, coolants, battery electrolytes.
 - 5) Vehicle or equipment, degreasing, steam cleaning and wash water.
 - 6) Concrete, mortar and plaster mix and cleaning water.
 - 7) Detergents and floatable wastes.
 - 8) Superchlorinated potable water line flushings.
 - c. Contain hazardous substances in a quantity reportable under Federal Regulations 40 CFR Parts 117 and 302.
 3. During performance of the Work, disposal of such materials shall occur at a temporary on-site location, physically separated from potential storm water runoff, with ultimate disposal in compliance with all applicable local, regional, State and Federal requirements.

4. Contractor shall obtain and comply with Storm Water Pollution Prevention Plan (SWPPP). Contractor shall be responsible for payment of the permit and all fines for non-compliance with the SWPPP, at no change in Contract Sum.
- F. Pavement Clearing and Cleaning: Keep site accessways, parking areas and building access and exit facilities clear of mud.
1. Remove mud, soil and debris and dispose in a manner which will not be injurious to persons, property, plant materials and site.
 2. Comply with runoff control requirements stated above and as required by authorities having jurisdiction.

PART 2 – PRODUCTS (NOT USED)

PART 3 – EXECUTION (NOT USED)

END OF SECTION 01 57 00

S201-ITB2, Volume 2 - SECTION 01 61 00– BASIC PRODUCT REQUIREMENTS

PART 1 - GENERAL

1.01 RELATED DOCUMENTS

- A. Construction Drawings, Technical Specifications, Addenda, and Contact Agreement, including any Addenda, including other Division 1 Specification Sections, apply to this Section.

1.02 SECTION INCLUDES

- B. General requirements for products used for the Work, including:
 - 1. General characteristics of products
 - 2. Product options
 - 3. System completeness
 - 4. Transportation and handling requirements
 - 5. Storage and protection of products
 - 6. Installation of products.

1.03 RELATED SECTIONS

- A. Section 01 33 00 - Submittals Procedures
- B. Section 01 41 00 - Regulatory Requirements
- C. Section 01 42 00 - Reference Standards and Abbreviations
- D. Section 01 63 00 - Product Substitution Requirements
- E. Section 01 65 00 - Product Delivery Requirements
- F. Section 01 66 00 - Product Storage and Handling Requirements

1.04 GENERAL PRODUCT REQUIREMENTS

- C. Products, General: "Products" include items purchased for incorporation in the Work, whether purchased for the Project or taken from previously purchased stock, and include materials, equipment, assemblies, fabrications and systems.
 - 7. Named Products: Items identified by manufacturer's product name, including make or model designations indicated in the manufacturer's published product data.
 - 8. Materials: Products that are shaped, cut, worked, mixed, finished, refined or otherwise fabricated, processed or installed to form a part of the Work.
 - 9. Equipment: A product with operating parts that are motorized or manually operated and require connections such as wiring or piping.

- D. Specific Product Requirements: Refer to requirements of Section 01 45 00 - Quality Control and individual product
- E. Minimum Requirements: Specified requirements for products are minimum requirements. Refer to general requirements for quality of the Work specified in Section 01 45 00 - Quality Control and elsewhere herein.
- F. Product Selection: Provide products that fully comply with the Contract Documents, are undamaged and unused at installation. Comply with additional requirements specified herein in Article titled "PRODUCT OPTIONS".
- G. Standard Products: Where specific products are not specified, provide standard products of types and kinds that are suitable for the intended purposes and that are usually and customarily used on similar projects under similar conditions. Products shall be as selected by Contractor and subject to review and acceptance by the FORA Construction Manager.
- F. Code Compliance: All products, other than commodity products prescribed by Code, shall have a current ICBO Evaluation Service (ICBO ES) Research Report or National Evaluation, Inc. Report (NER). Refer to additional requirements specified in Section 01 41 00 - Regulatory Requirements.
- G. Interchangeability: To the fullest extent possible, provide products of the same kind from a single source. Products required to be supplied in quantity shall be the same product and interchangeable throughout the Work. When options are specified for the selection of any of two or more products, the product selected shall be compatible with products previously selected.
- H. Product Nameplates and Instructions:
 - 1. Except for required Code-compliance labels and operating and safety instructions, locate nameplates on inconspicuous, accessible surfaces. Do not attach manufacturer's identifying nameplates or trademarks on surfaces exposed to view in occupied spaces or to the exterior.
 - 2. Provide a permanent nameplate on each item of service-connected or power-operated equipment. Nameplates shall contain identifying information and essential operating data such as the following example:
 - Name of manufacturer
 - Name of product
 - Model and serial number
 - Capacity
 - Operating and Power Characteristics
 - Labels of Tested Compliance with Codes and Standards
 - 3. For each item of service-connected or power-operated equipment, provide operating and safety instructions, permanently affixed and of durable construction, with legible machine lettering. Comply with all applicable requirements of authorities having jurisdiction and listing agencies.

1.05 PRODUCT OPTIONS

- H. Product Options: Provisions of Public Contract Code Section 03400 shall apply, as supplemented by the following general requirements.
- I. Products Specified by Description: Where Specifications describe a product, listing characteristics required, with or without use of a brand name, provide a product that has the specified attributes and otherwise complies with specified requirements.
- J. Products Specified by Performance Requirements: Where Specifications require compliance with performance requirements, provide product(s) that comply and are recommended by the manufacturer for the intended application. Verification of manufacturer's recommendations may be by product literature or by certification of performance from manufacturer.
- K. Products Specified by Reference to Standards: Where Specifications require compliance with a standard, provided product shall fully comply with the standard specified. Refer to general requirements specified in Section 01 42 00 - Reference Standards and Abbreviations regarding compliance with referenced standards, standard specifications, codes, practices and requirements for products.
- L. Products Specified by Identification of Manufacturer and Product Name or Number:
 - 4. Sole, source, no other product shall be accepted: Provide the specified product(s) of the specified manufacturer.
 - 5. "Acceptable Manufacturers": Product(s) of the named manufacturers, if equivalent to the specified product(s) of the specified manufacturer, will be acceptable in accordance with the requirements specified herein in the Article titled "'OR EQUAL' PRODUCTS."
 - 6. Unnamed manufacturers: Products of unnamed manufacturers will be acceptable only as follows:
 - a. Unless specifically stated that equals will not be accepted or considered, the phrase "or equal" shall be assumed to be included in the description of specified product(s). Equivalent products of unnamed manufacturers will be accepted in accordance with the "or equal" provision specified herein, below.
 - b. If provided, products of unnamed manufacturers shall be subject to the requirements specified herein in the Article titled "'OR EQUAL' PRODUCTS."
 - 7. Quality basis: Specified product(s) of the specified manufacturer shall serve as the basis by which products by named acceptable manufacturers and products of unnamed manufacturers will be evaluated. Where characteristics of the specified product are described, where performance characteristics are identified or where reference is made to industry standards, such characteristics are specified to facilitate evaluation of products by identifying the most significant attributes of the specified product(s).
- M. Products Specified by Combination of Methods: Where products are specified by a combination of attributes, including manufacturer's name, product brand name, product catalog or identification number, industry reference standard, or description of product characteristics, provide products conforming to all specified attributes.
- N. "Or Equal" Provision: Where the phrase "or equal" or the phrase "or approved equal" is included, product(s) of unnamed manufacturer(s) may be provided as specified above in subparagraph titled "Unnamed manufacturers."

1. The requirements specified herein in the Article titled "'OR EQUAL' PRODUCTS" shall apply to products provided under the "or equal" provision.
 2. Use of product(s) under the "or equal" provision shall not result in any delay in completion of the Work, including completion of portions of the Work for use by FORA or for work under separate contract by FORA.
 3. Use of product(s) under the "or equal" provision shall not result in any costs to FORA, including design fees and permit and plan check fees.
 4. Use of product(s) under the "or equal" provision shall not require substantial change in the intent of the design, in the opinion of the FORA Construction Manager. The intent of the design shall include functional performance and aesthetic qualities.
 5. The determination of equivalence will be made by the FORA Construction Manager, and such determination shall be final.
- O. Visual Matching: Where Specifications require matching a sample, the decision by the FORA Construction Manager on whether a proposed product matches shall be final. Where no product visually matches, but the product complies with other requirements, comply with provisions for substitutions for selection of a matching product in another category.
- P. Selection of Products: Where requirements include the phrase "as selected from manufacturer's standard colors, patterns and textures", or a similar phrase, selections of products will be made by indicated party or, if not indicated, by the FORA Construction Manager. The FORA Construction Manager will select color, pattern and texture from the product line of submitted manufacturer, if all other specified provisions are met.

1.06 "OR EQUAL" PRODUCTS

- Q. "Or Equal" Products: Products are specified typically by indicating a specified manufacturer and specific products of that manufacturer, with acceptable manufacturers identified with reference to this "or equal" provision. If Contractor proposes to provide products other than the specified products of the specified manufacturer, provisions of any relevant Contract Agreement Article, and Public Contract Code section 3400 shall apply. Contractor shall submit if and when directed by FORA Construction Manager, complete product data, including drawings and descriptions of products, fabrication details and installation procedures. Include samples where applicable or requested.
1. Submit a minimum of four copies. Form and other administrative requirements shall be as directed by the FORA Construction Manager.
 2. Include appropriate product data for the specified product(s) of the specified manufacturer, suitable for use in comparison of characteristics of products.
 - a. Include a written, point-by-point comparison of characteristics of the proposed equal product with those of the specified product.
 - b. If the proposed equal is accepted, Contractor shall include a detailed description in written or graphic form as appropriate, indicating all necessary changes or modifications to other elements of the Work and to construction to be performed by the FORA and others under separate contract with FOR A .
 3. "Or Equal" product submissions shall include a statement indicating the equal's effect on the Construction Schedule. Contractor shall indicate the effect of the proposed products

on overall Contract Time and, as applicable, on completion of portions of the Work for use by FORA for work under separate contract by FORA.

4. "Or Equal" product submissions shall include signed certification that the Contractor has reviewed the proposed products and has determined that the products are equivalent or superior in every respect to product requirements indicated or specified in the Contract Documents, and that the proposed products are suited for and can perform the purpose or application of the specified product indicated or specified in the Contract Documents.
 5. "Or Equal" product submissions shall include a signed waiver by the Contractor for change in the Contract Time or Contract Sum because of the following:
 - a. "Or equal" product failed to perform adequately.
 - b. "Or equal" product required changes in on other elements of the Work.
 - c. "Or equal" product caused problems in interfacing with other elements of the Work.
 6. If, in the opinion of the FORA Construction Manager, the "or equal" product request is incomplete or has insufficient data to enable a full and thorough review of the proposed products, the proposed products may be summarily refused and determined to be unacceptable.
- R. Product Substitutions: For products not governed by the "or equal" provision, comply with substitution provisions of Article 2 of the Contract Agreement and requirements specified in Section 01 63 00 - Product Substitution Procedures.

1.07 SYSTEM COMPLETENESS

S. System Completeness

1. The Contract Drawings and Specifications are not intended to be comprehensive directions on how to produce the Work. Rather, the Drawings and Specifications are instruments of service prepared to describe the design intent for the completed Work.
 2. It is intended that all equipment, systems and assemblies be complete and fully functional even though not fully described. Provide all products and operations necessary to achieve the design intent described in the Contract Documents.
 3. Refer to related general requirements specified in Section 01 41 00 – Regulatory Requirements regarding compliance with minimum requirements of applicable codes, ordinances and standards.
- T. Omissions and Misdescriptions: Contractor shall report to FORA Construction Manager immediately when elements essential to proper execution of the Work are discovered to be missing or misdescribed in the Drawings and Specifications or if the design intent is unclear.
1. Should an essential element be discovered as missing or misdescribed prior to receipt of Bids, an Addendum will be issued so that all costs may be accounted for in the Contract Sum.
 2. Should an obvious omission or misdescription of a necessary element be discovered and reported after execution of the Agreement, Contractor shall provide the element as though fully and correctly described, and a no-cost Change Order shall be executed.
 3. Refer to related general requirements specified in Section 01 31 00 - Coordination regarding construction interfacing and coordination.

1.08 TRANSPORTATION, DELIVERY AND HANDLING

- U. Transportation, Delivery and Handling, General: Contractor shall comply with manufacturer's instructions and recommendations for transportation, delivery and handling, in addition to the following.
- V. Transportation: Contractor shall transport products by methods to avoid product damage.
- W. Delivery:
 - 4. Contractor shall schedule delivery to minimize long-term storage and prevent overcrowding construction spaces. Contractor shall coordinate with installation to ensure minimum holding time for items that are flammable, hazardous, easily damaged, or sensitive to deterioration, theft and other losses.
 - 5. Contractor shall deliver products in undamaged condition in manufacturer's original sealed container or packaging system, complete with labels and instructions for handling, storing, unpacking, protecting and installing.
- X. Handling:
 - 1. Contractor shall provide equipment and personnel to handle products by methods to prevent soiling, marring or other damage.
 - 2. Contractor shall promptly inspect products on delivery to ensure that products comply with Contract Documents, quantities are correct, and to ensure that products are undamaged and properly protected.

1.09 STORAGE AND PROTECTION

- Y. Storage and Protection, General: Contractor shall store and protect products in accordance with manufacturer's instructions, with seals and labels intact and legible.
 - 3. Contractor shall periodically inspect to ensure products are undamaged, and are maintained under required conditions.
 - 4. Contractor shall remove and replace products damaged by improper storage or protection with new products at no change in Contract Sum or Contract Time.
 - 5. Contractor shall store sensitive products in weather tight enclosures.
- Z. Inspection Provisions: Contractor shall arrange storage to provide access for inspection and measurement of quantity or counting of units.
- AA. Structural Considerations: Contractor shall store heavy materials away from the structure in a manner that will not endanger supporting construction.
- BB. Weather-Resistant Storage:
 - 1. Contractor shall store moisture-sensitive products above ground, under cover in a weather tight enclosure or covered with an impervious sheet covering. Contractor shall provide adequate ventilation to avoid condensation.
 - 2. Contractor shall maintain storage within temperature and humidity ranges required by manufacturer's instructions.

3. For exterior storage of fabricated products, Contractor shall place products on raised blocks, pallets or other supports, above ground and in a manner to not create ponding or misdirection of runoff. Contractor shall place on sloped supports above ground.
4. Contractor shall store loose granular materials on solid surfaces in a well-drained area. Contractor shall prevent mixing with foreign matter.

CC. Protection of Completed Work:

1. Contractor shall provide barriers, substantial coverings and notices to protect installed Work from traffic and subsequent construction operations.
2. Contractor shall remove protective measures when no longer required and prior to Contract Completion review of the Work.
3. Contractor shall comply with additional requirements specified in Section 01 56 00 - Temporary Barriers and Enclosures.

PART 2 – PRODUCTS (NOT USED)

PART 3 - EXECUTION

3.01 INSTALLATION OF PRODUCTS

A. Installation of Products:

1. Contractor shall comply with manufacturer's instructions and recommendations for installation of products, except where more stringent requirements are specified and necessary due to Project conditions or are required by authorities having jurisdiction.
2. Contractor shall anchor each product securely in place, accurately located and aligned with other Work.
3. Contractor shall clean exposed surfaces and provide protection to ensure freedom from damage and deterioration at time of Contract Completion review. Contractor shall refer to additional requirements specified in Section 01 74 00 - Cleaning Requirements and Section 01 56 00 - Temporary Barriers and Enclosures.

END OF SECTION 01 61 00

S201-ITB2, Volume 2 - SECTION 01 63 00 – PRODUCT SUBSTITUTION PROCEDURES

PART 1 - GENERAL

1.01 RELATED DOCUMENTS

- A. Construction Drawings, Technical Specifications, Addenda, and Contract Agreement, including any Addenda, including other Division 1 Specification Sections, apply to this Section.

1.02 SECTION INCLUDES

- B. General requirements applicable to substitutions of materials, products, equipment and systems.

1.03 1.1 SUBSTITUTION OF MATERIALS AND EQUIPMENT

- A. Substitutions, General: Catalog numbers and specific brands or trade names are used in materials, products, equipment and systems required by the Specifications to establish the standards of quality, utility and appearance required. Alternative products which are of equal quality and of required characteristics for the purpose intended may be proposed for use provided the Contractor complies with provisions of Article 2 of the Contract Agreement, subject to the following provisions.

1. See Section 01 61 00 - Basic Product Requirements for requirements regarding product options.
2. Substitutions will only be authorized by properly executed Change Order or Field Instruction.
3. Note: FORA has no obligation to entertain substitutions.

- B. Substitution Provisions:

1. Documentation: Substitutions will not be considered if they are indicated or implied on shop drawing, product data or sample submittals. All requests for substitution shall be by separate written request from Contractor. See paragraph below for documentation required in the submission of request for substitution.
2. Cost and Time Considerations: Substitutions will not be considered unless a net reduction in Contract Sum or Contract Time results to FORA's benefit, including redesign costs, life cycle costs, plan check and permit fees, changes in related Work and overall performance of building systems.
3. Design Revision: Substitutions will not be considered if acceptance will require substantial revision of the Contract Documents or will substantially change the intent of the design, in the opinion of the FORA Construction Manager. The intent of the design shall include functional performance and aesthetic qualities.
4. Data: It shall be the responsibility of the Contractor to provide adequate data demonstrating the merits of the proposed substitution, including cost data and information regarding changes in related Work.

5. Determination by FORA Construction Manager: FORA Construction Manager and FORA consultants will determine the acceptability of proposed substitutions, and FORA Construction Manager will notify Contractor in writing of acceptance or rejection. The determination by the FORA Construction Manager regarding functional performance and aesthetic quality shall be final.
 6. Non-Acceptance: If a proposed substitution is not accepted, Contractor shall immediately provide the specified product.
 7. Substitution Limitation: Only one request for substitution will be considered for each product.
- C. Request for Substitution Procedures: Comply with provisions of Article 2 of the Contract Agreement and the following.
1. Contractor shall prepare a request for substitution and submit the request to FORA's consultant through FORA Construction Manager for review and recommendation for acceptance. Acceptance and approval of substitutions shall be by FORA Construction Manager
 - a. Submit a minimum of four copies.
 - b. Present the request for substitution using form provided by FORA Construction Manager.
 - c. Comply with other administrative requirements shall be as directed by FORA Construction Manager.
 2. Substitution requests shall include complete product data, including drawings and descriptions of products, fabrication details and installation procedures. Include samples where applicable or requested.
 3. Substitution requests shall include appropriate product data for the specified product(s) of the specified manufacturer, suitable for use in comparison of characteristics of products.
 - a. Include a written, point-by-point comparison of characteristics of the proposed substitute product with those of the specified product.
 - b. Include a detailed description, in written or graphic form as appropriate, indicating all changes or modifications needed to other elements of the Work and to construction to be performed by the FORA and by others under separate contracts with FORA that will be necessary if the proposed substitution is accepted.
 4. Substitution requests shall include a statement indicating the substitution's effect on the Construction Schedule. Indicate the effect of the proposed substitution on overall Contract Time and, as applicable, on completion of portions of the Work for use by FORA or for work under separate contracts by FORA.
 5. Except as otherwise specified, substitution requests shall include detailed cost data, including a proposal for the net change, if any, in the Contract Sum.
 6. Substitution requests shall include signed certification that the Contractor has reviewed the proposed substitution and has determined that the substitution, in combination with the cost or time savings, represents an equivalent or superior condition in every respect to product requirements and value indicated or specified in the Contract Documents, and that the substitution is suited for and can perform the purpose or application of the specified product indicated or specified in the Contract Documents.

7. Substitution requests shall include a signed waiver by the Contractor for change in the Contract Time or Contract Sum because of the following:
 - a. Substitution failed to perform adequately.
 - b. Substitution required changes in on other elements of the Work.
 - c. Substitution caused problems in interfacing with other elements of the Work.
 - d. Substitution was determined to be unacceptable by authorities having jurisdiction.
8. If, in the opinion of the FORA Construction Manager, the substitution request is incomplete or has insufficient data to enable a full and thorough review of the intended substitution, the substitution may be summarily refused and determined to be unacceptable.

D. Contract Document Revisions:

1. Should a Contractor-proposed substitution or alternative sequence or method of construction require revision of the Contract Drawings or Specifications, including revisions for the FOR A's consultant who is the responsible design professional will make revisions as approved in writing in advance by FORA Construction Manager.
2. Contractor shall pay for services of FORA's consultants, other responsible design professionals and FORA for researching and reporting on proposed substitutions or alternative sequence and method of construction when such activities are considered additional services to the design services contracts of FORA's consultant.
3. Contractor shall pay for costs of services by FORA's consultants, other responsible design professionals and FORA. These costs may include travel, reproduction, long distance telephone and shipping costs reimbursable at cost plus usual and customary mark-up for handling and billing.
4. Contractor shall pay such fees whether or not the proposed substitution or alternative sequence or method of construction is ultimately accepted by FORA and a Change Order is executed.

PART 2 – PRODUCTS (NOT USED)

PART 3– PRODUCTS (NOT USED)

END OF SECTION 01 63 00

S201-ITB2, Volume 2 - SECTION 01 65 00 – PRODUCT DELIVERY REQUIREMENTS

PART 1 - GENERAL

1.01 RELATED DOCUMENTS

- A. Construction Drawings, Technical Specifications, Addenda, and Contact Agreement, including any Addenda, including other Division 1 Specification Sections, apply to this Section.

1.02 SECTION INCLUDES

- B. Protect products scheduled for use in the work by means including, but not necessarily limited to, those described in this Section.

1.03 RELATED SECTIONS

- C. Section 01 61 00 - Basic Product Requirements
- D. Section 01 66 00 - Product Storage and Handling Requirements

1.04 QUALITY ASSURANCE

- E. Contractor's Quality Assurance: Contractor shall include within the Contractor's quality assurance program procedures as necessary to ensure protection of products upon delivery. Contractor shall be solely responsible for all products upon delivery to Work site and in off-site storage.
 - 1. Contractor shall schedule delivery to minimize long-term storage at Project site and to prevent overcrowding of construction spaces.
 - 2. Contractor shall coordinate delivery with installation time to ensure minimum holding time for items that are flammable, hazardous, easily damaged, or sensitive to deterioration, theft, and other losses.
 - 3. Contractor shall inspect products on delivery to ensure compliance with the Contract Documents and to ensure that products are undamaged and properly protected.
- F. Manufacturer's Requirements: Contractor shall determine and comply with manufacturer's instructions and recommendations for product handling.
- G. Packaging: Contractor shall deliver products to Work site in manufacturer's original containers, with labels intact and legible.
 - 1. Products delivered to Work site shall be in undamaged condition, in manufacturer's original sealed container or other packaging system, complete with labels and instructions for handling, storing, unpacking, protecting, and installing.
 - 2. Contractor shall maintain packaged materials with seals unbroken and labels intact until time of use.
 - 3. Products will be subject to rejection if they do not bear required identification or are unsuitably packaged.

H. Delivery:

1. Contractor shall address and deliver products to Project site. Do not deliver products to FORA. Address deliveries to Contractor and Project name. Do not address products "care of" FORA.
 2. FORA will not be responsible for misaddressed and misdelivered products, including claims for damage and delay.
- I. Damaged Products: In event of damage, Contractor shall promptly make replacements and repairs to packaging and contents, as acceptable to FORA Construction Manager, at no change in Contract Sum and Contract Time.

PART 2 – PRODUCTS (NOT USED)

PART 3 – EXECUTION (NOT USED)

END OF SECTION 01 65 00

S201-ITB2, Volume 2 - SECTION 01 66 00 – PRODUCT STORAGE AND HANDLING REQUIREMENTS

PART 1 - GENERAL

1.01 RELATED DOCUMENTS

- A. Construction Drawings, Technical Specifications, Addenda, and Contact Agreement, including any Addenda, including other Division 1 Specification Sections, apply to this Section.

1.02 SECTION INCLUDES

- B. Storage and protection requirements to ensure that products intended for use in the Work will not be damaged and will not deteriorate from time of delivery to time of incorporation into the Work.

1.03 RELATED SECTIONS

- C. Section 01 52 00 - Construction Facilities
- D. Section 01 52 50 - Construction Staging Areas
- E. Section 01 56 00 - Temporary Barriers and Enclosures
- F. Section 01 61 00 - Basic Product Requirements
- G. Section 01 65 00 - Product Delivery Requirements

1.04 QUALITY ASSURANCE

- H. Contractor's Quality Assurance: Contractor shall include within the Contractor's quality assurance program procedures as necessary to ensure protection of products after delivery to Work site. Contractor shall be solely responsible for all products stored on site and in off-site storage.
 - 1. Contractor shall protect stored products from damage.
 - 2. Contractor shall store products to allow for inspection and measurement of quantity or counting of units.
 - 3. Contractor shall store materials in a manner that will not endanger Project structure.
 - 4. Contractor shall store products that are subject to damage by the elements, under cover in a weather tight enclosure above ground, with ventilation adequate to prevent condensation.
- I. Manufacturer's Handling Requirements: Contractor shall determine and comply with product manufacturer's written instructions for handling products.
- J. Manufacturer's Storage Requirements: Contractor shall determine and comply with product manufacturer's written instructions for temperature, humidity, ventilation, and weather-protection requirements for storage.

- K. Storage: Contractor shall provide secure locations and enclosures at Project site for storage of materials and equipment. Contractor shall coordinate location with Contractor storage and staging areas. Refer to Section 01 52 00 - Construction Facilities and Section 01 52 50 - Construction Staging Areas.
 - 1. Contractor shall maintain packaged materials with seals unbroken and labels intact until time of use.
 - 2. Products will be subject to rejection if they do bear required identification or are unsuitably packaged.
- L. Damaged Products: In event of damage, Contractor shall promptly make replacements and repairs to packaging and contents, as acceptable to FORA Construction Manager, at no change in Contract Sum and Contract Time.

PART 2 – PRODUCTS (NOT USED)

PART 3 – EXECUTION (NOT USED)

END OF SECTION 01 66 00

S201-ITB1, Volume 2 - SECTION 01 72 00 – PREPARATION REQUIREMENTS

PART 1 - GENERAL

1.01 RELATED DOCUMENTS

- A. Construction Drawings, Technical Specifications, Addenda, and Contact Agreement, including any Addenda, including other Division 1 Specification Sections, apply to this Section.

1.02 SECTION INCLUDES

- A. Requirements for preparation prior to installing, applying and placing products to determine acceptable conditions for the Work.
- B. Layout of the Work and other engineering services necessary to accomplish the Work.

1.03 RELATED SECTIONS

- A. Section 01 3 10 - Coordination
- B. Section 01 31 20 - Project Meetings
- C. Section 01 32 10 - Construction Progress Schedules
- D. Section 01 73 20 - Cutting and Patching
- E. Section 01 77 00 - Contract Closeout Procedures
- F. Section 01 78 10 - Survey and Layout Data.
- G. Selective Demolition: Removal of existing construction in preparation of performance of specified Work, as represented on drawings.
- H. Section 02225 - Removals and Relocations: Removal of products in preparation for the Work.

1.04 LAYOUT OF WORK

- I. Surveyor: Contractor shall select and pay for services of a land surveyor, registered in the State of California, for proper performance of the Work.
 - 1. Services of surveyor shall be suitable for layout and verification of location of buildings and site elements.
 - 2. For the Project record, Contractor shall submit the name, address and telephone number of land surveyor before starting survey Work.

PART 2 – PRODUCTS (NOT USED)

PART 3 - EXECUTION

3.01 PREPARATION

- A. **Manufacturer's Requirements:** Contractor shall determine product manufacturer's requirements and recommendations prior to commencing Work.
- B. **Preparations:** Contractor shall perform preparation actions according to manufacturer's instructions and recommendations and according to specified procedures.
 - 1. Contractor shall perform surface preparation as necessary to create suitable substrates for application, installation and placement of products.
 - 2. Contractor shall notify FORA Construction Manager in writing of unsuitable conditions preventing proper performance of the Work.
- C. **Existing Utility Information:** Contractor shall furnish information to serving utility that is necessary to adjust, move, or relocate existing utility structures, utility poles, lines, services, or other utility appurtenances located in or affected by construction. Contractor shall coordinate with FORA Construction Manager and with authorities having jurisdiction.
- D. **Existing Utility Interruptions:** Contractor shall not interrupt utilities serving facilities occupied by others unless permitted under the following conditions and then only after arranging to provide temporary utility services according to requirements indicated:
 - 1. Contractor shall notify FORA Construction Manager not less than two working days in advance of proposed utility interruptions.
 - 2. Contractor shall not proceed with utility interruptions without written permission from FORA Construction Manager.
- E. **Field Measurements:** Contractor shall take field measurements as required to fit the Work properly. Contractor shall recheck measurements before installing each product. Where portions of the Work are indicated to fit to other construction, Contractor shall verify dimensions of other construction by field measurements before fabrication. Contractor shall coordinate fabrication schedule with construction progress to avoid delaying the Work.
- F. **Space Requirements:** Contractor shall verify space requirements and dimensions of items shown diagrammatically on Drawings.
- G. **Review of Contract Documents and Field Conditions:** Immediately upon discovery of the need for clarification of the Contract Documents, Contractor shall submit a Request for Interpretation (RFI) to FORA Construction Manager. Contractor shall include a detailed description of problem encountered, together with recommendations for changing the Contract Documents. Contractor shall submit requests in accordance with requirements specified in Section 01 31 13.1 - Requests for Interpretation (RFI), using form as directed by FORA Construction Manager.
- H. **Verification of Construction Layout:** Before proceeding to lay out the Work, Contractor shall verify layout information shown on Drawings, in relation to the property survey and existing benchmarks, and locate survey reference points. If discrepancies are discovered, Contractor shall promptly notify FORA Construction Manager.

3.02 FIELD ENGINEERING

- A. **Examination:** Contractor shall verify locations of survey control and reference points prior to starting Work. If discrepancies are discovered, Contractor shall promptly notify FORA Construction Manager.

- B. Survey Control and Reference Points: Contractor shall locate and protect survey control and reference points. Control datum for survey shall be as indicated on Civil Drawings. Notwithstanding the data on Civil Drawings, Contractor shall use NAD 83 State Plane Coordinate System for survey control and reference points.
1. Business and Professions Code section 8771 provides for the preservation of Survey Monuments in construction projects. This legislation mandates that, prior to construction, monuments shall be referenced in the field and "Corner Records" shall be prepared for filing in the Office of the County Surveyor. Contractor shall ensure that these shall be performed prior to Contract Completion of the Work.
 2. Contractor shall comply with requirements of authorities having jurisdiction for survey monumentation preservation on capital improvement projects where monumentation points are present.
 3. Contractor shall be responsible for preparing and submitting proper documentation to the Office of the County Surveyor in compliance with Business and Professions Code section 8771.
 4. Contract Completion and release of retainage shall be contingent upon obtaining documentation from Contractor's project surveyor or engineer that monuments have been set or restored and that Corner Records have been filed with and to the satisfaction of the County Surveyor.
 5. All costs and actions necessary for compliance with Business and Professions Code section 8771 shall be included in the Contract Sum and Contract Time.

3.03 SURVEYING AND FIELD ENGINEERING SERVICES

- C. Surveying and Field Engineering Services: Contractor shall provide surveying and field engineering services as necessary for performance of the Work.
1. Contractor shall be responsible for the accuracy and adequacy of surveying and field engineering services.
 2. Contractor shall utilize recognized engineering practices.
 3. Contractor shall check the location, level and plumb, of every major element as the Work progresses.
 4. Contractor shall preserve construction survey stakes and marks for the duration of their usefulness.
 5. If construction survey stakes are lost or disturbed, and require replacement, Contractor shall perform replacement at no change in Contract Sum and Contract Time.
 6. Contractor shall excavate all holes necessary for line and grade stakes.
- D. Surveying for Layout and Control of the Work: Contractor shall establish elevations, lines and levels for all Work under the Contract. Contractor shall locate and lay out by instrumentation and similar appropriate means:
1. Site improvements, including pavements, curbs, headers, sewers, storm drains, structures, and paving. Note on Project Record Drawings utility locations, slopes and invert elevations.

2. Stakes for cutting, filling, grading and topsoil placement, to establish finished grade or flow line indicated on Contract Drawings.
 - a. Contractor shall preserve construction survey stakes and marks for the duration of their usefulness.
 - b. If construction survey stakes are lost or disturbed, and require replacement, Contractor shall perform replacement at no change in Contract Sum and Contract Time.
 - c. Contractor shall excavate all holes necessary for line and grade stakes.
 3. Grid or axis for structures, building foundation, column locations and ground floor elevations.
 4. Contractor shall establish benchmarks and control points to set lines and levels at each story of construction and elsewhere as needed to locate each element of Project.
 5. Contractor shall establish dimensions within tolerances indicated. Contractor shall not scale Drawings to obtain required dimensions.
 6. Contractor shall inform installers of lines and levels to which they must comply.
 7. When deviations from required lines and levels exceed allowable tolerances, Contractor shall notify University's Representative, Architect and Project Inspector.
 8. Contractor shall close site surveys with an error of closure equal to or less than the standard established by authorities having jurisdiction.
- E. Monuments: Contractor shall establish a minimum of two permanent monuments on site, referenced to established control points. Contractor shall record locations, with horizontal and vertical data, on Project Record Drawings.
1. In accordance with Business and Professions Code section 8772, any monument set by a licensed land surveyor or registered civil engineer to mark or reference a point on a property or land line shall be permanently and visibly marked or tagged with the certificate number of the surveyor or civil engineer setting it, each number preceded by the letters "L.S." or "R.C.E." respectively, as the case may be, or, if the monument is set by a public agency, it shall be marked with the name of the agency and the political subdivision it serves.
 2. Nothing in this Section shall prevent the inclusion of other information on the tag which will assist in the tracing or location of survey records which relate to the tagged monument.
 3. Contractor shall ensure that centerline ties filed with the County Surveyor will be checked for compliance with this law.
- F. Site Grading Verification: Upon completion of grading, Contractor shall survey graded areas and establish that elevations are correct and within acceptable tolerances for paving and finish grading.
- G. Verification of Work: Contractor shall periodically verify layout and completed conditions of the Work by same means.

END OF SECTION 01 72 00

S201-ITB1, Volume 2 - SECTION 01 66 00 – EXECUTION REQUIREMENTS

PART 1 - GENERAL

1.01 RELATED DOCUMENTS

- A. Construction Drawings, Technical Specifications, Addenda, and Contact Agreement, including any Addenda, including other Division 1 Specification Sections, apply to this Section.

1.02 SECTION INCLUDES

- B. General requirements for installing, applying and placing products.
- C. General requirements for correction of defective Work.

1.03 RELATED SECTIONS

- D. Section 01 31 20 - Project Meetings: Pre-installation and coordination conferences where procedures for installing, applying and placing products prior to performance of the Work.

1.04 EXECUTION

- E. Manufacturer's Requirements: Contractor shall determine product manufacturer's requirements and recommendations prior to commencing Work.
- F. Execution: Contractor shall perform installation, application and placement actions according to manufacturer's instructions and recommendations and according to specified procedures.
 - 1. Contractor shall perform surface preparation as necessary to create suitable substrates for application, installation and placement of products.
 - 2. Contractor shall notify FORA Construction Manager in writing of unsuitable conditions preventing proper performance of the Work.

PART 2 – PRODUCTS (NOT USED)

PART 3 – EXECUTION (NOT USED)

3.1 INSTALLATION, APPLICATION AND PLACEMENT OF PRODUCTS

- A. Manufacturer's Instructions: Contractor shall comply with manufacturer's written instructions and recommendations for installing, applying, placing and finishing products.
- B. Installation, Application and Placement, General: Contractor shall locate the Work and components of the Work accurately, in correct alignment, orientation and elevation, as indicated.
 - 1. Contractor shall make vertical work plumb and make horizontal work level.

2. Where space is limited, Contractor shall install components to maximize space available for maintenance and ease of removal for replacement.
 3. Contractor shall conceal pipes, ducts, and wiring in finished areas, unless otherwise indicated.
 4. Contractor shall maintain minimum headroom clearance of 8 feet in spaces without a suspended ceiling, unless otherwise directed.
 5. Contractor shall install products at the time and under conditions that will ensure the best possible results. Contractor shall maintain conditions required for product performance until acceptance of the Work.
 6. Contractor shall conduct construction operations so no part of the Work is subjected to damaging operations or loading in excess of that expected during normal conditions of occupancy.
- C. Tools and Equipment: Contractor shall not use tools or equipment that produce harmful noise levels.
- D. Anchors and Fasteners: Contractor shall provide anchors and fasteners as required to anchor each component securely in place, accurately located and aligned with other portions of the Work.
1. Mounting Heights: Where mounting heights are not indicated, Contractor shall mount components at heights directed by Architect.
 2. Contractor shall allow for building movement, including thermal expansion and contraction.
- E. Joints: Contractor shall make joints of uniform width. Where joint locations in exposed work are not indicated, Contractor shall arrange joints for the best visual effect. Contractor shall fit exposed connections together to form hairline joints.
- E. Hazardous Materials: Contractor shall use products, cleaners, and installation materials that are not considered hazardous.
- F. Cleaning: Contractor shall comply with requirements specified in Section 01 74 00 - Cleaning Requirements. See individual product Specifications Sections for specific cleaning procedures to be performed.
- G. Protection: Contractor shall provide barriers, covers and other protective devices as recommended by manufacturer and complying with general requirements specified in Section 01 56 00 - Temporary Barriers and Enclosures.
1. Contractor shall comply with manufacturer's written instructions for temperature and relative humidity.
 2. See individual product Specifications Sections for specific protective measures to be provided.
- H. Limiting Exposures: Contractor shall supervise construction operations to assure that no part of the construction, completed or in progress, is subject to harmful, dangerous, damaging, or otherwise deleterious exposure during the construction period.

3.2 OWNER-INSTALLED PRODUCTS

- A. Site Access: Contractor shall provide access to Project site for FORA's construction forces and those performing work for FORA under separate contracts. Contractor shall coordinate with requirements specified in Section 01 55 00 - Vehicular Access and Parking.
- B. Coordination: Contractor shall coordinate construction and operations of the Work with work performed by FORA by separate contract or with FORA's construction forces.
 - 1. Construction schedule: Contractor shall inform FORA Construction Manager of Contractor's preferred construction schedule for FORA-installed work. Contractor shall adjust construction schedule based on a mutually agreeable timetable. Contractor shall notify FORA Construction Manager if changes to schedule are required due to differences in actual construction progress.
 - 2. Pre-installation and coordination conferences: Contractor shall include FORA's construction forces at pre-installation and coordination conferences covering portions of the Work that are to receive FORA-installed work. If portions of the Work depend on FORA-installed products, Contractor shall attend pre-installation conferences conducted by University's construction forces.

3.3 CORRECTION OF THE WORK

- A. Correction of the Work, General: Contractor shall repair or remove and replace defective construction. Contractor shall restore damaged substrates and finishes to match original and new surrounding construction.
 - 1. Contractor shall comply with requirements in Section 01732 - Cutting and Patching Procedures.
 - 2. Repairing shall include replacing defective parts, refinishing damaged surfaces, touching up with matching materials, and properly adjusting operating equipment.
 - 3. Contractor shall remove and replace damaged surfaces that are exposed to view if surfaces cannot be repaired without visible evidence of repair.
 - 4. Contractor shall repair components that do not operate properly. Remove and replace operating components that cannot be repaired.
 - 5. Contractor shall remove and replace chipped, scratched, and broken glass.
- B. Restoration of Existing Conditions: Contractor shall restore permanent facilities used during construction to their original condition or to match new construction.

END OF SECTION

S201-ITB2, Volume 2 - SECTION 01 73 20 – CUTTING AND PATCHING REQUIREMENTS

PART 1 - GENERAL

1.01 RELATED DOCUMENTS

- A. Construction Drawings, Technical Specifications, Addenda, and Contract Agreement, including any Addenda, including other Division 1 Specification Sections, apply to this Section.

1.02 SECTION INCLUDES

- B. Requirements and procedural requirements for cutting and patching, including:
 - 1. Cutting and patching not required to be performed as part of the Work specified in other Sections.
 - 2. Cutting and patching existing construction altered or disturbed to accommodate Work.
 - 3. Cutting and patching existing construction damaged or defaced during Work as required to restore to existing or better condition at the time of award of Contract.
 - 4. Cutting and patching required to:
 - a. Install or correct non-coordinated Work.
 - b. Remove and replace defective and non-conforming Work.
 - c. Remove samples of installed Work for testing.
- C. Refer to other Sections and drawings for specific requirements of the extent and limitations applicable to cutting and patching, demolishing, or altering existing construction of individual parts of the Work.

1.03 RELATED SECTIONS

- D. Section 01 11 00 - Summary of the Work
- E. Section 01 56 00 - Temporary Barriers and Enclosures
- F. Section 01 74 00 - Cleaning Requirements
- G. Selective Demolition: Cutting and removal of existing construction, as represented on drawings

1.04 SUBMITTALS

- H. Written Requests for Cutting and Alteration: Coordinate with requirements as specified on drawings
 - 1. Contractor shall submit written request in advance of cutting or alteration which affects:

- a. Work by FORA's construction forces or by others under separate contract with FORA.
 - b. Existing construction not otherwise indicated to be revised by Work under the Contract.
2. Contractor shall include in requests for cutting and alteration:
 - a. Identification of Project.
 - b. Location and description of affected Work. Include shop drawings as necessary to identify locations and communicate descriptions.
 - c. Explanation of necessity for cutting and patching.
 - d. Description of proposed Work and products to be used.
 - e. Alternatives to cutting and patching.
 - f. Effect on existing construction.
 - g. Effect on work by FORA's construction forces or by separate contractors performing work for FORA.
 3. Contractor shall include written evidence that those performing work under separate contract for FORA have been notified and acknowledge that cutting and patching work will be occurring. Contractor shall include written permission for intended cutting and patching, included scheduled times.
 4. Contractor shall indicate date and time cutting and patching Work will be performed, including duration.
 5. Contractor shall describe the extent of cutting and patching required and how it is to be performed.
 6. Contractor shall describe anticipated results in terms of changes to existing construction; include changes to structural elements and operating components as well as changes in the building's appearance and other significant visual elements.
 7. Contractor shall list products to be used and firms or entities that will perform work.
 8. Contractor shall list utilities that will be disturbed or affected, including those that will be relocated and those that will be temporarily out-of-service. Contractor shall indicate how long service will be disrupted.
 9. Where cutting and patching involves addition of reinforcement to structural elements, Contractor shall submit details to show how reinforcement is integrated with the original structure.
 10. Approval by the FORA Construction Manager to proceed with cutting and patching does not waive the FORA Construction Manager right to later require complete removal and replacement of a part of the Work found to be unsatisfactory.
 11. Contractor shall minimize effects on FORA operations and on concurrent operations construction by other contractors.

PART 2 - PRODUCTS

2.01 PATCHING MATERIALS

- A. Patching at Paving: At portland cement concrete paving, Contractor shall use concrete mix with maximum 3/8-inch aggregate and minimum 3000 psi 28-day compressive strength. Contractor shall provide dowels to existing paving and reinforce new paving with minimum No. 3 reinforcing steel bars at 16-inches on center each way. Welded wire fabric reinforcement will not be acceptable.

PART 3 - EXECUTION

3.01 EXAMINATION

- A. Examination, General: Before cutting existing surfaces, Contractor shall examine surfaces to be cut and patched and conditions under which cutting and patching is to be performed. Contractor shall take corrective action before proceeding, if unsafe or unsatisfactory conditions are encountered. Contractor shall inspect existing conditions prior to commencing Work, including elements subject to damage or movement during cutting and patching.
 - 1. Before proceeding, Contractor shall meet at the site with parties involved in cutting and patching, including asbestos abatement, mechanical and electrical trades. Contractor shall review areas of potential interference and conflict. Contractor shall coordinate procedures and resolve potential conflicts before proceeding.
 - 2. Beginning of cutting or patching shall be interpreted to mean that existing conditions were found by Contractor to be acceptable.
 - 3. After uncovering existing Work, Contractor shall inspect conditions affecting proper accomplishment of Work.

3.02 PREPARATION

- A. Protection: Contractor shall protect existing facilities during cutting and patching to prevent damage. Contractor shall provide protection from adverse weather conditions for portions of the Project that might be exposed during cutting and patching operations.
- B. Contractor shall avoid interference with use of adjoining areas or interruption of free passage to adjoining areas.
- C. Contractor shall take all precautions necessary to avoid cutting existing pipe, conduit or ductwork serving the building lateral.
- D. Weather Protection: Contractor shall provide protection from elements for areas which may be exposed by uncovering Work. Contractor shall maintain excavations free of water.

3.03 CUTTING AND PATCHING

- A. Cutting and Patching, General: Contractor shall execute cutting, fitting, and patching, excavation and fill, as necessary to complete the Work. Contractor shall employ skilled

workers to perform cutting and patching. Contractor shall proceed with cutting and patching at the earliest feasible time and complete without delay. Contractor shall:

4. Coordinate installation or application of products for integrated Work. Avoid having to cut and patch new substrates and finishes.
5. Uncover completed Work as necessary to install or apply products out of sequence.
6. Cut, remove and replace defective and non-conforming Work.
7. By-pass utility services such as pipe or conduit, before cutting, where services are shown or required to be removed, relocated or abandoned. Cut-off pipe or conduit in walls or partitions to be removed. Cap, valve or plug and seal the remaining portion of pipe or conduit to prevent entrance of moisture or other foreign matter after by-passing and cutting.

B. Cutting: Contractor shall:

1. Cut existing construction using methods least likely to damage elements to be retained or adjoining construction. Where possible review proposed procedures with the original installer; comply with the original installer's recommendations. Provide appropriate surfaces to receive final finishing.
2. Execute cutting and patching of weather-exposed, moisture-resistant elements and surfaces exposed to view by methods to preserve weather, moisture and visual integrity.

C. Patching: Contractor shall inspect and test patched areas to demonstrate integrity of the installation.

3.04 CLEANING

A. Cleaning: Contractor shall thoroughly clean areas and spaces where cutting and patching is performed or used as access. Contractor shall remove completely paint, mortar, oils, putty and items of similar nature. Contractor shall thoroughly clean piping, conduit and similar features before painting or other finishing is applied. Contractor shall restore damaged pipe covering to its original condition.

END OF SECTION 01 73 20

S201-ITB1, Volume 2 - SECTION 01 74 00 – CLEANING REQUIREMENTS

PART 1 - GENERAL

1.01 RELATED DOCUMENTS

- A. Construction Drawings, Technical Specifications, Addenda, and Contact Agreement, including any Addenda, including other Division 1 Specification Sections, apply to this Section.

1.02 SECTION INCLUDES

- A. Cleaning during construction.
- B. Cleaning for Contract Completion review and final acceptance of the Work.

1.03 RELATED SECTIONS

- A. Additional Requirements: Cleaning for specific products or elements of Work are described in individual product Specification Sections as represented on drawings.

1.04 SUBMITTALS

- A. Product List: Contractor shall submit complete list of all cleaning agents and materials for FORA Construction Manager's review and approval.
- B. Cleaning Procedures: Contractor shall submit description of cleaning processes, agents and materials to be used for final cleaning of the Work. Processes and degree of cleanliness shall be as directed by FORA Construction Manager. All cleaning processes, agents and materials shall be subject to FORA Construction Manager's review and approval.

1.05 QUALITY ASSURANCE

- A. Cleaning and Disposal Requirements, General: Contractor shall conduct cleaning and disposal operations in compliance with all applicable codes, ordinances and regulations, including environmental protection laws, rules and practices.
- B. Cleaning Workers: Contractor shall employ experienced workers or professional cleaners for final cleaning. Contractor shall clean each surface or unit to the condition expected in a normal, commercial building cleaning and maintenance program. Contractor shall comply with manufacturer's instructions.

PART 2 - PRODUCTS

2.01 MATERIALS

- A. Cleaning Agents and Materials: Contractor shall use only those cleaning agents and materials which will not create hazards to health or property and which will not damage or degrade surfaces. Contractor shall:

1. Use only those cleaning agents, materials and methods recommended by manufacturer of the material to be cleaned.
2. Use cleaning materials only on surfaces recommended by cleaning agent manufacturer.

PART 3 - EXECUTION

3.01 CLEANING DURING CONSTRUCTION

- A. Garbage Control: Contractor shall control accumulation of debris, waste materials and rubbish. Periodically, Contractor shall dispose of debris, waste and rubbish off-site in a legal manner.
- B. Cleaning, General: Contractor shall clean sidewalks, driveways and streets frequently to maintain public thoroughfares free of dust, debris and other contaminants.
- C. Parking Area Cleaning: Contractor shall keep parking areas clear of construction debris, especially debris hazardous to vehicle tires.
- D. Thoroughfare Clearing and Cleaning: Contractor shall keep site accessways, parking areas and building access and exit facilities clear of mud, soiling and debris. Contractor shall:
 1. Remove mud, soil and debris and dispose in a manner which will not be injurious to persons, property, plant materials and site.
 2. Comply with runoff control requirements stated above and as required by governing authorities having jurisdiction.
- C. Cleaning Frequency: At a minimum, Contractor shall clean Work areas daily.
- D. Failure to Clean: Should cleaning by Contractor not be sufficient or acceptable to FORA Construction Manager cleaning and deduct costs for such cleaning from sums owed to Contractor.

3.02 CONTRACT COMPLETION REVIEW CLEANING, GENERAL

- A. Contract Completion Review Cleaning, General: Contractor shall execute a thorough cleaning prior to Contract Completion review by FORA Construction Manager. Contractor shall complete final cleaning before submitting final Application for Payment. Contractor shall:
 1. Conduct cleaning in compliance with regulations of authorities having jurisdiction and industrial safety standards for cleaning.
 2. Employ professional building cleaners to thoroughly clean building.
 3. Complete cleaning operations specified below before requesting inspection for Certification of Completion. Contractor shall clean the site, including landscape development areas, of rubbish, litter and foreign substances. Sweep paved areas broom clean; remove stains, spills and other foreign deposits.
- B. Waste Disposal, Contractor shall:
 1. Remove waste materials from the site and conduct disposal in a lawful manner.
 2. Do not burn waste materials.

3. Do not bury debris or excess materials on the Project Site.
4. Do not discharge volatile, harmful or hazardous materials into drainage systems.
5. Where extra materials of value remaining after completion of associated work have become the FORA's property, arrange for disposition of these materials as directed.

3.03 EXTERIOR CLEANING

- A. Site Cleaning: Contractor shall broom clean exterior paved surfaces. Contractor shall rake clean other surfaces of the grounds. Contractor shall:
 6. Wash down and scrub where necessary all paving soiled as a result of construction activities. Thoroughly remove mortar droppings, paint splatters, stains and adhered soil.
 7. Remove from the site all construction waste, unused materials, excess soil and other debris resulting from the Work. Legally dispose of waste.

3.04 PEST CONTROL

- A. Pest Control: Contractor shall engage an experienced, licensed exterminator to inspect and rid the project area of insects, rodents and other pests.
 1. Exterminator shall prepare and submit report of inspection and extermination.
 2. Extermination materials shall comply with applicable pest control regulations and not leave toxic residue harmful to humans.

3.05 CLEANING INSPECTION

- A. Cleaning Inspection: Prior to Final Payment or acceptance by FORA for partial occupancy or beneficial use of the premises, Contractor and FORA Construction Manager shall jointly conduct an inspection of interior and exterior surfaces to verify that entire Work is acceptably clean.
- B. Inadequate Cleaning: Should final cleaning be inadequate, as determined by FORA Construction Manager, and Contractor fails to correct conditions, FORA may engage cleaning service under separate contract and deduct cost from Contract Sum.

END OF SECTION 01 74 00

S201-ITB1, Volume 2 - SECTION 01 78 90 – PROJECT RECORD DOCUMENTS

PART 1 - GENERAL

1.01 RELATED DOCUMENTS

- A. Construction Drawings, Technical Specifications, Addenda, and Contract Agreement, including any Addenda, including other Division 1 Specification Sections, apply to this Section.

1.02 SECTION INCLUDES

- B. Requirements for Project Record Documents to be submitted for Contract closeout.

1.03 PROJECT RECORD DOCUMENTS

- A. Project Record Documents, General: Contractor shall not use Record Documents for construction purposes. Contractor shall protect from deterioration and loss in a secure, fire-resistive location
- B. Record Drawings: Contractor shall record information continuously as Work progresses. Contractor shall not conceal Work permanently until all required information is recorded. Contractor shall:
 - 1. Maintain a clean, undamaged set of blue or black line white-prints of Contract Drawings and Shop Drawings. Mark the set to show the actual cut & cap of utilities as accurately as possible.
 - 2. Where Shop Drawings are used, record a cross-reference at the corresponding location on the Contract Drawings. Give particular attention to concealed elements that would be difficult to measure and record at a later date.
 - 3. Legibly and to scale, mark record sets with red erasable pencil. Use other colors to distinguish between variations in separate categories of the work.
 - 4. Note related Change Order numbers where applicable.
 - 5. Organize record drawing sheets into manageable sets, bind with durable paper cover sheets, and print suitable titles, dates and other identification on the cover of each set.
 - 6. Store Record Documents separate from documents used for construction.
- C. Submission:
 - 1. Contractor shall keep Project Record Documents current, as they will be reviewed for completeness by Architect, Inspector, and University's Representative as condition for certification of each Progress Payment Application.
 - 2. Prior to the date of the Notice of Completion, Contractor shall submit marked Record Documents to Architect for review, approval and further processing.

PART 2 – PRODUCTS (NOT USED)

PART 3– PRODUCTS (NOT USED)

END OF SECTION 01 78 90

S201-ITB2, Volume 2 - SECTION 02 41 16 – DEMOLITION AND REMOVAL

PART 1 - GENERAL

1.01 RELATED DOCUMENTS

- A. Construction Drawings, Technical Specifications, Addenda, and Contact Agreement, including any Addenda, including other Division 1 Specification Sections, apply to this Section.

1.02 SECTION INCLUDES

- A. Demolition of buildings
- B. Removal of construction debris

1.03 RELATED SECTIONS

- A. Section 01 11 00 – Summary of Work
- B. Section 01 14 00 – Work Restrictions
- C. Section 01 33 30 – Submittals
- D. Section 01 33 55 – Safety and Health Procedures
- E. Section 01 56 00 – Temporary Barriers and Enclosures

1.04 SUMMARY

- A. The Contractor shall furnish all tools, equipment, materials, transportation and supplies and shall perform all labor necessary to complete demolition, removal, salvage, and disposal of the Surplus II buildings and all building components, mechanical and electrical components, and structural elements as shown on the Drawings and required by these Specifications.
- B. Once the demolition of a building is started, it shall be continued until completed
- C. A Demolition Permit shall be procured from the City of Seaside before commencing building demolition. There will be no charge for the permit.
- D. Section Includes:
 - 1. In general, work will consist of the demolition of concrete, surplus military structures Demolition includes but is not limited to, roofing, roof framing, purlins, parapets, trusses, girders, cladding, siding, columns, bracing, foundations, steel grates, mechanical supports, concrete floors, utilities, piping, lighting, flooring, conductors, conduit, and other miscellaneous building elements.
 - 2. All components, equipment, pipelines, attached appurtenances, and utilities within and attached to the interior or exterior of the structures listed above shall be removed, unless directed otherwise. Underground utilities serving the structures shall be cut off or disconnected below the pavement surface a minimum of ten (10) feet from the building foundation, unless directed otherwise.

3. Design and installation of temporary shoring as needed.
- E. Refer to statutory definitions as required by state or local agencies or use the definitions below.
 1. Remove: Remove and legally dispose of items, except those identified for use in recycling, re-use, and salvage programs.
 2. Demolition: Dismantle, demolish, remove and disposal of all building materials.
 3. Dismantle: The process of removing building components and structural framing members by method suitable to avoid free fall and to prevent ground impact or dust generation.
 4. Existing to Remain: Existing items of construction that are not to be permanently removed and that are not otherwise indicated to be removed, removed and salvaged, or removed and reinstalled

1.05 MATERIALS OWNERSHIP

- A. Except for items or materials indicated to be reused, salvaged, reinstalled, or otherwise indicated to remain property of Owner or FORA, demolished materials shall become the Contractor's property and shall be removed, recycled, or disposed from Project site in an appropriate and legal manner.
- B. Unless otherwise indicated, demolition waste becomes property of Contractor.

1.06 MEETINGS

- A. Pre-demolition Conference: Conduct conference at Project site at least 3 weeks prior to start of demolition.
 1. Discuss demolition removal, and finalize disposal plan.
 2. Review and finalize demolition schedule and verify availability of materials, demolition personnel, equipment, and facilities needed to make progress and avoid delays.
 3. Review truck route to and from legal disposal site.

1.07 SUBMITTALS

- A. All submittals shall be prepared in accordance with SECTION 01 33 00 SUBMITTAL PROCEDURES.
- B. Submittals for Demolition phase:
 1. Demolition Work Plan. Submit proposed demolition and removal plan to FORA and obtain approval before work is started. The Demolition Work Plan shall include the proposed demolitions, removal, salvage, hazardous material handling, and disposal procedures. The following is required:

- a. Structural Dismantle Plan. Provide plans and narrative on process that will be used to ensure demolition and removal of all building components will be accomplished in a safe and controlled manner.
- b. Procedures for erection and maintenance of temporary structural shoring, scaffolding, removal and disposition of materials. Provide description of structural stabilization during construction and non-work periods. Structural shoring plans shall be signed by a civil or structural engineer licensed in the State of California.
- c. Proposed Protection Measures. Submit report, including drawings, that indicates the measures proposed for protecting individuals and property for environmental protection, for dust control, and for noise control. Indicate proposed locations and construction of barriers.
- d. Detailed sequence of demolition and removal work, including start and end dates for each activity.
- e. Interruption of utility services. Provide utility sequencing and comply with restriction in other sections of specifications. Indicate how long utility services will be interrupted.
- f. Coordination for shutoff, capping, and continuation of utility services. Submit on methods to cap existing utilities.

2. Traffic control shall be in accordance with the traffic control plan.

1.08 DOCUMENTS AND PUBLICATIONS

A. American National Standards Institute (ANSI).

- 1. ANSI A10.6 1990 - Safety Requirements for Demolition Operations

1.09 QUALITY ASSURANCE

A. Regulatory Requirements: Comply with all OSHA, CAL-OSHA, and other applicable federal, state, and local regulations, including air pollution, environmental, health, safety, hauling, and disposal regulations. In the event of conflict between these requirements, the most stringent provisions shall govern.

B. Daily Reports. Prepare and maintain a Daily Report of demolition and Debris Removal indicating extents, locations and operations. Furnish a copy thereof to the Engineer at the inclusion of each week's work. At a minimum, the Daily Report shall include date, period covered by the report, equipment used, description of activity, types and quantities of demolition materials removed each day and to-date, and other comments relative to the operations.

1.10 PROTECTION

- A. Existing Improvements. Protect existing improvements to remain in place in accordance with SECTION 01 14 00 - WORK RESTRICTIONS. Restoration work necessitated by damage incurred during construction shall be performed at no additional cost to FORA. Restored work shall be subject to final approval by the FORA Construction Manager.
- B. The Contractor shall notify USA at 811 at least two (2) days prior to starting work and shall coordinate all work with utility company representatives. The existence and locations of existing underground facilities shown on the Drawings were obtained from a search of available records. The Contractor shall take precautionary measures to protect any existing facilities shown on the Drawings, and any other which is not of record or not shown on the Drawings.
- C. Protection of Existing Improvements and Facilities: All surface and subsurface existing improvements and facilities within the project limits which are to remain in place and shall be protected from damage from Contractor operation, in accordance with SECTION 01 14 00 – Work Restrictions. All active utility services, including water and sewer systems, shall be kept operational at all times.

1.11 SAFETY DURING CONSTRUCTION

- A. The Contractor shall assume sole and complete responsibility for job site conditions during the course of construction of the Project, including safety of all persons and property. This requirement shall be made to apply continuously and not be limited to normal working hours.
- B. Where pedestrian and driver safety is endangered in the work of demolition and removal, and disposal of work, including protecting and restoring existing improvements, use traffic barriers with flashing lights and other approved safety devices. Notify the FORA Construction Manager prior to beginning any such work.
- C. Comply with federal, state, and local hauling and disposal regulations. Conform to ANSI 10.6.
- D. Comply with Health and Safety Plans and Requirements per SECTION 01 41 50 HEALTH AND SAFETY REQUIREMENTS.

PART 2 - PRODUCTS

2.01 PERFORMANCE REQUIREMENTS

- A. Regulatory Requirements: Comply with governing EPA and Monterey Bay Unified Air Pollution Control District notification regulations before beginning selective demolition. Comply with hauling and disposal regulations of authorities having jurisdiction.
- B. Standards: Comply with ANSI/ASSE A10.6 and NFPA 241.

PART 3 – EXECUTION

3.01 EXAMINATION

- A. Verify that utilities have been disconnected and capped.
- B. Review record documents of existing construction. District does not guarantee that existing conditions are same as those indicated in record documents
- C. Survey existing conditions and correlate with requirements indicated to determine extent of demolition and recycling required.
- D. Survey condition of the building to determine whether removing any element might result in a structural deficiency or unplanned collapse of any portion of the structure or adjacent structures during demolition. Retain a licensed and qualified civil or structural engineer to provide analysis, including calculations, necessary to ensure the safe execution of the demolition work.
- E. Perform surveys as the Work progresses to detect hazards resulting from demolition activities.
- F. Survey of Existing Conditions: Record existing conditions by use of preconstruction photographs or preconstruction videotapes.

3.02 GENERAL

- A. Protect all facilities to remain.
- B. Comply with all applicable federal, state, and local hauling and disposal regulations, including air pollution and environmental regulations.
- C. Comply with all applicable traffic control requirements required by the District and those on the terminal.
- D. Prevent the spread of dust and debris, and avoid the creation of a nuisance or hazard in the surrounding area. Dust nuisance passing beyond the contractor construction limits shall not be allowed.
- E. Noise shall be kept at a reasonable level as related to specific items of equipment used, and their hours of use. Comply noise levels in Contract Agreement.
- F. Provide temporary construction fencing, in accordance with specifications and project Drawings per Section 01 56 00 – Temporary Barriers and Enclosures.
- G. Demolition and removal of materials including debris shall be disposed of at legal sites outside Project Site in compliance with all federal, state, and local regulations, approved Materials Management and Disposal Plan, and in accordance with project Health and Safety Plan (HSP). All materials are required to be removed under this Contract. Contractor shall protect existing utilities to remain as shown on the Drawings and will be held responsible for damage resulting from Contractor's failure to protect these utilities.
- H. Blasting is not permitted.

3.03 UTILITY SERVICES AND MECHANICAL/ELECTRICAL SYSTEMS

- A. Existing Services/Systems to Remain: Maintain services/systems indicated to remain and protect them against damage.
 - 1. Comply with requirements for existing services/systems interruptions specified in Contract Agreement and 01 51 00 – Temporary Utilities.
- B. Existing Services/Systems to Be Removed, Relocated, or Abandoned: Locate, identify, disconnect, and seal or cap off indicated utility services and mechanical/electrical systems serving areas.
 - 1. Coordinate shutoff with nearby occupied buildings.
 - 2. Arrange to shut off indicated utilities with utility companies.
 - 3. Disconnect and remove all interior lights, exterior lights, power control devices, circuitry, power control devices, and all electrical work in the buildings.
 - 4. Disconnect, demolish, and remove fire-suppression systems, plumbing, and associated components indicated to be removed.
 - a. All above ground piping is to be removed. Remove portion of piping indicated to be removed and cap remaining piping with same or compatible piping material.. All others not shown shall be plugged with 6-inch thick plug of concrete placed securely in the pipe end to provide closure.

Drainage from waterlines shall be captured and disposed in sanitary sewer or shall be dechlorinated and disposed in the storm drain system.
 - b. Equipment to Be Removed: Disconnect and cap services and remove equipment.
 - c. All below grade piping is to be capped a minimum of 10 feet from the building footprint.
 - d. Contractor shall contact Pacific Gas and Electric to determine best method to cap gas and electric, as required.

3.04 PREPARATION

- A. Site Access and Temporary Controls: Conduct demolition and debris-removal operations to ensure minimum interference with adjacent terminal traffic, vehicular traffic ways, and other adjacent occupied and used facilities.
 - 1. Comply with requirements for access and protection specified in Division 01.
- B. Temporary Facilities: Provide temporary barricades and other protection required to prevent injury to people and damage to adjacent facilities and facilities to remain.
 - 1. Provide protection to ensure safe passage of people around selective demolition area and to and from occupied portions of building.
- C. Temporary Shoring: Provide and maintain shoring, bracing, and structural supports as required to preserve stability and prevent movement, settlement, or collapse of

construction and finishes to remain, and to prevent unexpected or uncontrolled movement or collapse of construction being demolished.

1. Strengthen or add new supports when required during progress of demolition
- D. Contractor shall mark locations of utilities to be protected in place, if applicable.
- E. Contractor shall saw cut existing pavement to their full depth to provide a clean and smooth edge at limits of demolition.

3.05 EXPLOSIVES

- A. Explosives: Use of explosives will not be permitted.

3.06 ENVIRONMENTAL CONTROLS

- A. Comply with federal, state and local regulations pertaining to water, air, solid waste, recycling, chemical waste, sanitary waste, sediment, and noise pollution.
- B. Protection of Natural Resources: Preserve the natural resources within the project boundaries or restore to an equivalent condition.
 1. Confine demolition activities to areas defined by work area limits indicated on the drawings.
 2. Water Resources: Comply with applicable regulations concerning the direct or indirect discharge of pollutants to underground and natural surface waters.
 - a. Storm Water Pollution Prevention Plan: Prepare implement and maintain Storm Water Pollution Prevention Plan (SWPPP).
 - b. Oily Substances: Prevent oily or other hazardous substances from entering the ground, drainage areas, or local bodies of water in such quantities as to affect normal use, aesthetics, or produce a measurable ecological impact on the area.
 - 1) Store and service construction equipment at areas designated for collection of oil wastes.
 3. Dust Control, Air Pollution, and Odor Control: Prevent creation of dust, air pollution and odors.
 - a. Use water suppression to prevent dust emissions.
 - b. If needed, use temporary enclosures and other appropriate methods to limit dust and dirt rising and scattering in air to lowest practical level.
 - b. Store volatile liquids, including fuels and solvents, in closed containers.
 - c. Properly maintain equipment to reduce gaseous pollutant emissions.

3.07 DISPOSAL PRACTICES AND WASTE HAULING

- A. Legally transport and dispose of materials that cannot be delivered to a source-separated or mixed recycling facility to a transfer station or disposal facility that can legally accept the materials for the purpose of disposal.
- B. Use waste hauler or Contractor's trucking services and personnel with certifications compliant with local, state and federal requirements. To confirm valid permitted status of waste haulers, refer to the California Department of Toxic Substances Control (<http://www.dtsc.ca.gov/database/Transporters/Trans000.cfm>).
- C. Become familiar with the conditions for acceptance of new construction, excavation and demolition materials at recycling facilities, prior to delivering materials.
- D. Deliver to facilities that can legally accept new construction, excavation and demolition materials for purpose of re-use, recycling, composting, or disposal.
- E. Do not burn, bury or otherwise dispose of rubbish and waste materials on project site.

3.08 DEMOLITION

- A. Once demolitions is started, it shall be continued until completed.
- B. Demolish building components completely and remove from the site except where materials are to be reused, salvaged, or otherwise indicated to remain property of the Owner. Use methods required to complete Work within limitations of governing regulations and as follows:
 - 1. Locate demolition equipment throughout the building and remove debris and materials so as not to impose excessive loads on supporting walls, floors, or framing.
 - 2. Demolish concrete and masonry in sizes that will be suitable for acceptance at recycling, disposal facilities, or for crushing and reuse.
 - 3. Remove structural framing members and lower to ground by method suitable to avoid free fall and to prevent ground impact or dust generation dismantle in sizes suitable for acceptance for recycling or disposal facilities.
 - 4. Break up and remove building elements on grade in small sizes, , suitable for acceptance at recycling or disposal facilities.
- B. Damages: Promptly repair damages to adjacent facilities caused by demolition operations to FORA Construction Manager satisfaction and approval at no additional cost to FORA.

3.09 HANDLING OF DEMOLISHED MATERIALS

- A. General: Promptly transport, dispose, re-use, salvage, recycle demolished materials. Do not allow demolished materials to accumulate or be stored on-site for more than **15** calendar days, unless authorized by the FORA Construction Manager.
- B. Burning: Do not burn materials.

- C. Disposal: Transport demolished materials off project site and legally reuse, salvage, recycle, or dispose of materials.

END OF SECTION 02 41 16

S201-ITB1, Volume 2 – PCB Ballasts, Universal Wastes, & Coolant Gasses Specification: 02 79 01

1.01 SECTION INCLUDES

- A. PCB Ballast Removal and Disposal Operations
- B. Universal Waste (Non-Incandescent lighting, batteries, mercury switches and gauges) Removal and Disposal
- C. Coolant Gas Removal & Reclaiming from Refrigerated Equipment

1.02 RELATED DOCUMENTS

- A. Contract Documents including hazardous material-related plans and specifications and all other project construction documents. Refer to Section 02 10 11 Summary of Hazardous Materials Work, Article 1.04 Related Documents for a more detailed listing.
- B. Refer to 02 41 00 Building Removal, Section 3.07, for Environmental Requirements.

1.03 REGULATIONS

- A. The Contractor shall comply with the requirements of the current issue of the following regulations and guidelines governing PCB's, mercury and other hazardous material removal, handling, storage and disposal as well as any other applicable Federal, State, and Local Government regulations. The regulations and guidance documents listed herein are incorporated by reference.
 - 1. Code of Federal Regulations (CFR):
 - a. 29 CFR 1926, Construction Standards
 - b. 40 CFR 750.41, Final Rule
 - c. 40 CFR Parts 261, 265, and 268, Hazardous Waste Management
 - d. 40 CFR Part 761, PCBs Manufacturing, Processing, Distribution in Commerce, and use Prohibitions
 - e. 40 CFR Part 82, Protection of Stratospheric Ozone: Supplemental Rule Regarding a Recycling Standard Under Section 608 of the Clean Air Act; Final Rule
 - f. 49 CFR Parts 172, 173, 178, 179, Hazardous Material Transportation
 - 2. California Code of Regulations (CCR):
 - a. 8 CCR Division 1, Chapter 4, Construction Safety Orders
 - b. 22 CCR Division 4.5, Environmental Health Standards for Management of Hazardous Waste
 - c. 22 CCR Division 4.5, Chapter 23 Universal Waste Rule

3. Disposal Requirements for PCB Waste, EH-231-056/1294 (December 1994).
4. "Guidance on the Management of Polychlorinated Biphenyls (PCBs)," Environmental Guidance Manual, DOE Office of Environmental Guidance, RCRA/CERCLA Division (EH-231), DOE/EH-0350, June 1993.

B. Refer to Instructions to Bidders, Section 9.26, for Prevailing Wage Regulations.

1.04 Definitions

A. Definitions specific to the work of this section:

1. Coolant Gasses – Refrigerant gasses that are known or suspected to contain regulated chlorofluorocarbon (CFC) or hydrochlorofluorocarbon (HCFC) gasses whose release to atmosphere is prohibited, and which require special equipment and EPA certified refrigerant reclaimer personnel to safely and properly remove the gasses for recycling or destruction at a permitted facility so that the remaining equipment to be removed can be disposed of in accordance with regulation.
2. Fluorescent Light Ballast (FLB) – A device that electrically controls fluorescent light fixtures. Most existing FLBs include a capacitor containing 0.1 kilograms or less of dielectric fluid that may contain PCBs. Ballasts manufactured prior to 1979 may contain PCB capacitors. More recently, electronic ballasts have come into use which do not have dielectric fluids or PCBs. Ballasts with PCB capacitors also contain asphalt potting compounds which are likely to contain PCBs.
3. Polychlorinated Biphenyl (PCB) – PCB's are any chemical substances consisting of the biphenyl molecule chlorinated to varying degrees or any combination of such molecules. PCB's have had a wide variety of uses in the past including dielectric fluids in capacitors. PCB's are clear to yellow oily substances which are toxic to the liver and reproductive system. PCB's are also suspect human carcinogens.
4. PCB Ballast – An FLB that is known or suspected to contain PCBs. All FLBs must be considered PCB ballasts unless they are:
 - a. Labeled or marked "No PCB" by the manufacturer.
 - b. Manufactured in 1979 or later as indicated and verified on a date stamp or code, located on the ballast.
 - c. Labeled as "Electronic Ballasts" by the manufacturer.
 - d. General Electric HDF Ballasts manufactured from 1977 to 1978 and which have a "W" added to their catalogue number on the label of the ballast.
5. PCB Transformer – A transformer manufactured prior to July 2, 1979, that contains three pounds or more of fluid other than mineral oil and whose PCB concentration is not established, is a PCB Transformer (i.e. greater than or equal to 500 parts per

- million) or a transformer originally designed to contain mineral oil as the dielectric fluid and which has been tested and found to contain 500 parts per million or greater of PCBs. If the date of the manufacture and the type of dielectric fluid are unknown, any person must assume the transformer to be a PCB Transformer.
6. PCB Contaminated Transformer – A transformer which contains fluid whose PCB concentration is equal to or greater than 50 parts per million and less than 500 parts per million.
 7. Fluorescent Lamp or Tube – A low pressure electric discharge lamp which generates ultraviolet light radiation by the passage of an arc through mercury vapor; the inner surface of the lamp tube is coated with a phosphor which absorbs the ultraviolet light and converts some of it to visible light. Spent fluorescent typically contain mercury in concentrations exceeding the total threshold limit concentration (TTLC) and/or the soluble threshold limit concentration (STLC) making them a presumptive hazardous waste in California.
 8. Mercury – A silvery liquid, metallic element which is toxic by inhalation and skin absorption. Mercury is a poison to the central nervous system and gastrointestinal system. Mercury is considered an inorganic persistent and bioaccumulative toxic substance subject to Cal/EPA hazardous waste regulations.
 9. Hazardous Waste – Any waste material that is listed or meets the criteria for hazardous waste as set forth in California Code of Regulations (CCR), Title 22, Article 9 or Article 11. At minimum, the following shall be considered to be hazardous wastes with respect to this section:
 - a. PCB ballasts
 - b. Fluorescent light tubes
 - c. High Intensity discharge (HID) lamps containing mercury
 - d. Mercury containing materials or items exceeding the TTLC value of 20 parts per million (ppm) or the STLC value of 0.2 ppm per section 66261.24 (a) (2) A of 22 CCR.
 10. Incinerator – An engineered device using controlled flame combustion to thermally degrade PCBs and PCB items. Examples of devices used for incineration include rotary kilns, liquid injection incinerators, cement kilns, and high temperature boilers.
 11. Recycling – Spent fluorescent tubes can be recycled, allowing for the recovery of mercury, glass, and aluminum endcaps. There are four facilities within California Authorized by Cal/EPA for recycling of fluorescent tubes. Metals associated with PCB ballasts can be recycled but the PCB must be incinerated by an EPA permitted TSD facility.

12. TSD Facility – An EPA or State permitted facility for transportation, storage, and disposal of hazardous wastes.
13. Leak or Leaking – Any instance in which a PCB Article, PCB Container or PCB Equipment has any PCBs on any portion of its external surface.
14. PCB-Contaminated Material – A non-liquid material containing PCBs at concentrations greater than or equal to 50 parts per million but less than 500 parts per million; a liquid material containing PCBs at concentrations greater than or equal to 50 parts per million but less than 500 parts per million or where insufficient liquid material is available for analysis, a non-porous surface having a surface concentration of greater than 10 micrograms per 100 square centimeters but less than 100 micrograms per 100 square centimeters, measured by a standard wipe test as defined in 40 CFR 761.123.
15. Universal Waste – Certain common designated hazardous wastes that are required to be handled, disposed of or recycled in accordance with special rules. Includes fluorescent light tubes, mercury switches, mercury thermostats, certain batteries (often used in building alarms and emergency systems), and other items.

1.05 SUBMITTALS

- A. Refer to Section 02 10 11 Summary of Hazardous Materials Work for submittal requirements applicable to this Section and the Contract submittal procedures section unless otherwise noted.

1.06 ENVIRONMENTAL CONSULTANT

- A. FORA's Environmental Consultant will provide oversight of the Contractor's hazardous material related work of this section including but not be limited to: submittal review; inspection of removal process, areas and removed items; and disposal operations and documents.

1.07 EXPOSURE MONITORING

- A. Personnel monitoring and other monitoring which is required by regulation and/or otherwise necessary for worker protection shall be the responsibility of the Contractor.

1.08 SPECIAL PROVISIONS

- A. The Contractor shall hold FORA, FORA's Representatives, Agents and Environmental Consultant harmless for claims, damages, losses, and expenses, including attorney's fees, arising out of or resulting from the Contractor's hazardous materials work, hazardous materials spills on the site or during transport to the disposal site, or any

other condition resulting from the Contractor's non-compliance with regulation or the Contract Documents.

PART 2 - PRODUCTS

2.01 MATERIALS

- A. All materials to be used on the project shall be new in original packages, containers, or bundles bearing the name of the manufacturer and the brand name. Used materials will not be permitted on this project.
- B. Protective Covering: All polyethylene sheeting shall be of 6 mil thickness unless specified elsewhere.
- C. Duct tape 2" or wider, capable of sealing joints of adjacent sheets of plastic sheets and for attachment of plastic sheets to finished or unfinished surfaces or dissimilar materials and capable of adhering under both dry and wet conditions.
- D. Clean-up solvents shall be low flash solvents such as stoddard solvent or approved equivalent.
- E. Protective Packaging:
 - 1. Clear, air and liquid tight, sealable 6 mil polyethylene bags shall be used for inner packaging of FLB for disposal in small quantities and/or "leakers".
 - 2. Sealable drums shall be DOT type 17 C or 17 H with tight fitting lids.
 - 3. Absorbent materials for lab packing drums for Class I landfill disposal shall be oil absorbent such as HAZORB® or approved equivalent.
 - 4. Labels – all drums and shipping containers for PCB ballasts shall be labeled at minimum as follows:
 - a. Yellow PCB caution label with the following information:

CAUTION
CONTAINS
PCBS
(Polychlorinated Biphenyls)

A toxic environmental contaminant requiring special handling and disposal in accordance with U.S. Environmental Protection Agency Regulations 40 CFR 761 - For Disposal Information Contact the nearest U.S.E.P.A. Office

In case of accident or spill, call toll free the U.S. Coast Guard National Response Center: 800-424-8802

Also Contact: _____

Telephone Number: _____

b. Shipping label containing the following information:

- 1) RQ, Polychlorinated Biphenyls, 9, UN 2315, PG2
- 2) Name and address of generator
- 3) Date removed
- 4) Contents: (i.e. PCB lighting ballasts)
- 5) Waste manifest number

PART 3 - EXECUTION

3.01 COORDINATION REQUIREMENTS

- A. The Contractor shall coordinate electrical power to ensure all lighting systems are de-energized and coordinate with the Environmental Consultant for inspection of removed ballasts, any PCB or PCB contaminated equipment or items, and any Universal Wastes prior to packaging and/or drumming for disposal.
- B. The Environmental Consultant shall be provided the opportunity to verify the proper identification and segregation of PCB ballasts prior to the ballasts being placed in sealed shipping containers. Provide any required test results of other PCB or PCB contaminated items or equipment

3.02 WORKER PROTECTION PROCEDURES

- A. Each worker assigned to perform work under this section shall be trained on the hazards of mercury, PCBs and other chemicals to be used for work under this section and the Contractor's protective measures and procedures to prevent and control worker exposure. Such training shall be completed and documented prior to assignment of each worker to tasks covered by this section.
- B. Workers shall put on the appropriate chemically resistant gloves prior to PCB Ballasts, Transformers with PCB oil and clean-up of PCB-Contaminated Materials. In addition, for removal and handling leaking PCB ballasts or clean-up of PCB-Contaminated Materials, full body disposable protective suits shall be worn.

- C. Workers shall not eat, drink, smoke, or chew gum or tobacco while engaged in PCB ballast removal, handling or clean-up. Prior to leaving the Work Area to take a break or at the end of a work shift, each worker will carefully wash their hands using warm soapy water.
- D. Prior to starting removal operations, lock-out/tag-out electrical power to all systems to be removed.

3.03 LIGHTING BALLAST AND TRANSFORMER SYSTEM REMOVAL

- A. Verify lock-out/tag-out of electrical power to all lighting and transformer systems to be removed has been completed.
- B. Establish separate protected laydown areas (i.e. pallets protected with plastic sheeting) for PCB and non-PCB wastes to facilitate inspection by the Environmental Consultant prior to containerizing for storage and shipping.
- C. Remove fluorescent tubes and/or mercury HID lamps without breaking them and place in protective storage containers to avoid breakage.
- D. Place removed lighting tubes and HID lamps in secure labeled storage pending shipment for disposal or recycling.
- E. Remove systems and place on a work surface protected with at minimum one layer of six mil plastic sheeting.
- F. Open the lighting fixture to examine the ballast system. If the ballast is marked “No PCB”, electronic ballast, or has a date stamp indicating it was manufactured in 1979 or later, it shall be considered a non-PCB ballast. All other ballasts shall be treated as PCB ballasts in the absence of valid product information to the contrary.
- G. PCB ballasts which show evidence of leakage require the appropriate oil resistant gloves worn prior to handling.
 - 1. Leakage of asphalt potting compound requires use of disposable oil resistant gloves such as Neoprene rubber gloves.
 - 2. Leakage of a clear to yellowish oily substance requires use of VITON® or “Silver Shield®” gloves for handling. Additionally, a disposable protective coverall shall be worn as needed to prevent contamination of personal clothing.
- H. Place PCB ballasts on plastic sheeting in pre-determined lay down area for inspection prior to shipping and disposal as a hazardous waste. PCB ballasts with evidence of leakage shall be double wrapped and sealed in plastic sheeting or bags.

- I. Place disposable gloves and coveralls in a six mil plastic waste bag containing a PCB warning label. Seal and place in pre-labeled shipping container(s).
- J. Request the Environmental Consultant to conduct an inspection daily to verify proper identification and segregation of lighting ballasts based on PCB content. Upon satisfactory completion of inspection, carefully place PCB ballasts in approved, labeled, storage/shipping containers or drums and place in secure storage pending disposal as a PCB waste.
- K. After inspection and upon approval of the Environmental Consultant or representation, place non-PCB ballasts in a waste bin for non-hazardous construction waste.

3.04 PCB SURFACE CONTAMINATION, CLEAN-UP AND/OR DISPOSAL

- A. Surfaces which have become contaminated by asphalt potting compound(s) or PCB oil leakage from a leaky PCB ballast and/or PCB transformer shall be either disposed of as PCB contaminated items subject to FORA's approval or cleaned and decontaminated of PCB residue.
- B. Clean-up and decontamination procedures:
 - 1. Protect all proximate surfaces such as floors below contaminated surfaces with two layers of six mil plastic sheeting.
 - 2. Put on protective coveralls, PCB resistant gloves, and an approved respirator with organic cartridges.
 - 3. Cordon off the area with barrier tape and remove all sources of ignition within 50 feet of the cleaning area.
 - 4. Secure building ventilation to the area and provide adequate ventilation through use of windows, other passive ventilation. Clean surface using clean rags dampened with an approved safety solvent such as stoddard solvent. Use minimum amount of solvent necessary to dampen rags.
 - 5. Wipe items on surfaces until no visible signs of contamination are present. At minimum, three separate wipe downs with fresh cleaning materials is required. Porous surfaces may have to be abraded to remove contaminated substrate that cannot be adequately cleaned by solvent wiping.
 - 6. Place spent cleaning materials in sealed plastic bags labeled with the PCB caution label. Place sealed bags in approved shipping container(s) for disposal as a PCB hazardous waste (>500 ppm).

7. Request an inspection by the Environmental Consultant to verify the effectiveness of the clean-up. The adequacy of the clean-up shall be determined by visual inspection of the surfaces by the Environmental Consultant and, at FORA's discretion, by clearance wipe sampling per 40 CFR Part 761 Subpart G. The clean-up shall be considered satisfactory if the surface wipe result(s) are below 10 micrograms of PCB per 100 square centimeters of surface area.
8. Where porous substrate surface must be removed to adequately decontaminate, bulk samples must be taken to ensure all PCB contamination above allowable levels have been removed and disposed of as PCB waste.

3.05 BALLAST DISPOSAL

- A. Non-PCB ballasts and/or non-PCB transformers may be disposed of as regular non-hazardous construction waste.
- B. PCB ballasts and/or Transformers with PCB oil or assumed PCB oil shall be sampled, stored, and disposed of as California Hazardous Waste according to one of the following two methods as directed by FORA or Environmental Consultant:
 1. Disposal in appropriate packaging along with a suitable non-biodegradable absorbent material and subsequent burial at an approved Class I Hazardous Waste Landfill (dependent upon laboratory results and method of disposal).
 2. Disposal by incineration of PCB containing materials at an EPA permitted incinerator site that meets 40 CFR 761 requirements with non-hazardous metals being salvaged and recycled. There are a number of other out of state EPA permitted hazardous waste sites which can accept PCB wastes for incineration.
- C. All shipping containers and drums containing PCB ballasts and/or Transformers with PCB oil or assumed PCB oil are to be labeled with the yellow PCB "Contains PCBs" caution labels along with the name and address of the generator, date removed, description of waste, waste manifest number, and DOT shipping designation: RQ, Polychlorinated Biphenyls, 9, UN 2315, PG2.
- D. A California hazardous waste manifest shall be prepared by the Contractor and used for each shipment of PCB ballasts, Transformers with PCB oil or assumed PCB oil and PCB-Contaminated Materials.

3.06 NON-INCANDESCENT LIGHTING TUBE AND LAMP DISPOSAL

- A. Spent fluorescent light tubes, mercury HID lamps, sodium vapor lamps and other non-incandescent lighting wastes shall be considered hazardous wastes and labeled as such for temporary on-site storage, transportation and disposal.

- B. Fluorescent lighting tubes and HID lamps shall be disposed of as a hazardous mercury waste at a permitted land disposal site or recycled. Fluorescent tubes can be transported to a California permitted recycler.
- C. A California hazardous waste manifest shall be used for all mercury containing lighting waste transported for land disposal.
- D. At minimum, a Bill of Lading shall be used to transport spent lighting tubes to an authorized lighting tube recycler.
- E. The Contractor shall provide the Environmental Consultant with copies of each hazardous waste manifest or Bill of Lading for shipping of mercury containing lighting wastes for disposal or recycling.
- F. All other Universal Wastes, including sodium lamps and batteries, shall be packaged, labeled, shipped and disposed of as hazardous waste according to regulation

3.07 MERCURY THERMOSTATS AND GAUGES

- A. Carefully remove mercury containing thermostats, gauges or other mercury containing items and place in suitable shipping container with packing materials.
- B. Ship as a Universal Waste to a permitted mercury recycling center.

3.08 REMOVAL AND RECLAIMING OF COOLANT GASSES & HALON

- A. All air conditioning units, refrigerators, and refrigerated water drinking fountains shall be assumed to contain regulated CFC and/or HCFC gasses subject to federal and state regulation pertaining to containment and recycling.
- B. Use only properly EPA certified Refrigerant Reclaimer technicians to remove CFC or HCFC from equipment to be removed and scrapped.
- C. Remove CFC and HCFC gasses by approved equipment and methods which prevent escape to the atmosphere and recycle removed gasses in accordance with applicable federal and state regulation.
- D. Removed refrigerant gasses must be recycled or destroyed per regulation.
- E. Remove Halon system and recycle or destroy Halon gas per federal and state regulation.sj

3.09 STOPPING THE WORK

- A. If at any time FORA or Environmental Consultant decide the Contractor's work practices are violating Specifications, Federal, State, or Local regulations to the extent of potential



2984 Teagarden Street, San Leandro, CA 94577

endangerment of building users, workers, the public and/or the environment, the Contractor will be notified (followed up in writing) that operations shall cease until corrective action is taken.

- B. The Contractor shall take such corrective action before proceeding with work. Loss or damage due to Stop Work Order(s) shall be the Contractor's responsibility. A Stop Work Order issued by FORA or Environmental Consultant shall become effective immediately.

**END OF S201-ITB1, VOLUME 2
PCB BALLASTS, UNIVERSAL WASTES, & COOLANT GASSES**

S201-ITB1, Volume 2 – Asbestos Abatement Specification: 02 82 00

PART 1 - GENERAL

1.01 SECTION INCLUDES

- A. Class I Asbestos Removal Operations
- B. Class II Asbestos Removal Operations

1.02 RELATED DOCUMENTS

- A. Contract Documents including hazardous material survey report summaries for each building and other hazardous material specifications.
- B. Refer to Section 02 10 11 Summary of Hazardous Materials Work, Article 1.04 Related Documents for a more detailed listing.
- C. Refer to 02 41 00 Building Removal, Section 3.07, for Environmental Requirements.
- D. Refer to 31 11 00 Vegetation Removal, Section 2.01 and 3.02, for temporary site fencing.

1.03 REFERENCES

- A. General - Codes, regulations and references applicable to asbestos abatement work include by are not limited to the most current edition of the following:

1. Code of Federal Regulations

29 CFR 1910.20	General Safety and Health Provisions Access to Employee Exposure and Medical Records.
29 CFR 1910 Subpart I	Personal Protective Equipment.
29 CFR 1910.145	Specifications for Accident Prevention Signs and Tags.
29 CFR 1926.1101	Asbestos.
29 CFR 1926.103	Respiratory Protection
34 CFR 231 Append. C	Procedures for Containing and Removing Building Materials Containing Asbestos.
40 CFR Part 61 Subpart A and M	USEPA, National Emission Standards for Hazardous Air Pollutants (NESHAPS).
40 CFR Part 763	Asbestos-Containing Materials in Schools; Final Rule and Notice.
42 CFR Part 84	HEPA Filters

2. California Code of Regulations;

Title 8, Article 2.5	Registration for Asbestos Work Sections 341.6 through 341.14.
Title 8, Section 1529	Asbestos.
Title 8, Section 5144	Respiratory Protection
Title 22, Division 4.5	Environmental Health Standards for Management of Hazardous Waste

3. Monterey Bay Unified Air Pollution Control District (MBUAPCD): NESHAP Rule 424 & Rule 306

4. California Environmental Protection Agency, Air Resource Board, Final Regulation Order, Section 93105, *Asbestos Airborne Toxic Control Measures for Construction, Grading, Quarrying, and Surface Mining Operations.*

5. Local Fire Department Regulations

6. American National Standards Institute (ANSI) publications;

Z9.2	Fundamentals Governing the Design and Operation of Local Exhaust Systems.
Z87.1	Occupational and Educational Eye and Face Protection.
Z88.2	Practices for Respiratory Protection.
Z89.1	Requirements for Protective Headgear for Industrial Workers.
Z41	Personal Protection - Protective Footwear.
Z88.6	Respiratory Protection - Respiratory Use Physical Qualifications for Personnel.

7. American Society for Testing and Materials (ASTM): Asbestos Control: Surveys, Assessment, Abatement, and Maintenance; 3rd Edition (March 2015); Chapters 6, 7, & 8.

8. ANSI/Compressed Gas Association, Inc.:

G-7.1 Commodity Specification for Air

9. National Fire Protection Association (NFPA);

No. 70. National Electrical Code.

10. UL 586-77 (r1982) Test Performance of High Efficiency Particulate Air Filter Units (June 10, 1977, 5th Ed.; Rev. March 12, 1982).

11. National Institute for Occupational Safety and Health (NIOSH)
N31, 3rd Ed.; Vol. 1 Manual of Analytical Methods, Method 7400

B. Refer to Instructions to Bidders, Section 9.26, for Prevailing Wage Regulations.

1.04 DEFINITIONS

A. In addition to the definitions in Section 01011 Summary of Hazardous Materials Work, the following definitions are specific to work of this section:

1. Asbestos: includes chrysotile, amosite, crocidolite, tremolite, anthophyllite, and actinolite asbestos, and any of these minerals that have been chemically treated or altered.
2. Asbestos Containing Construction Material (ACCM): Any manufactured construction material, which contains more than one tenth of one percent asbestos by weight.
3. Asbestos Containing Material (ACM): Any material containing more than one percent asbestos.
4. Asbestos Containing Waste Material: Any waste generated by the disturbance or removal of ACM including, but not limited to: ACCM, ACM, asbestos waste generated from control devices, particulate asbestos material, asbestos slurries, unfiltered waste water, used asbestos contaminated polyethylene sheeting, use disposable protective clothing and equipment, and any used mop heads, rags or other miscellaneous clean-up equipment waste.
5. Asbestos-related Work: Any activity, which by disturbing ACCMs, ACMs or PACMs may release asbestos fibers into the air.
6. City of Seaside (City): The Owner of the site and buildings to be removed for future site re-use.
7. Class I Asbestos Removal Operations: Class I Asbestos work means activities involving the removal of thermal system insulation (TSI) and surfacing ACM and PACM.
8. Class II Asbestos Removal Operations: Class II Asbestos Work means activities involving the removal of ACM, which is not TSI, or surfacing material. This includes but is not limited to, the removal of asbestos-containing wallboard, floor tile and sheeting, roofing and siding shingles, and construction mastics.
9. FORA: Fort Ord Reuse Authority (FORA) and its designated representatives for managing this project and project site for the City of Seaside (City). For the hazardous materials-related work of this project, FORA's Representatives include the Environmental Consultant under contract with FORA to provided hazardous materials observation and monitoring services.

10. Glovebag: An impervious plastic bag-like enclosure affixed around not more than a 60"x 60" ACM or ACCM, with glove-like appendages through which material and tools may be handled.
11. Hazardous Asbestos Waste: Friable waste with an asbestos content equal to or greater than one-percent asbestos including all associated dust, debris and plastic sheeting used during abatement. All asbestos containing waste material generated during removal and clean-up of RACM including friable ACM and non-friable ACM removed by aggressive means or otherwise made friable during the removal process is considered to be Asbestos Containing Waste Material subject to hazardous waste disposal rules.
12. Negative Pressure Enclosure (NPE): An enclosed or contained area of any configuration constructed of polyethylene sheeting with a minimum of four (4) air changes per hour and a negative pressure of -0.02 inches of water as compared to surrounding area outside the enclosure. NPE must be maintained until final air clearance sampling.
13. Non-Hazardous Asbestos Waste: Wastes which are non-friable ACM waste and/or any waste material resulting from removal of a construction material with an asbestos content less than one percent by weight as determined by objective testing accepted by the USEPA and OSHA. These wastes require OSHA Asbestos Hazard warning labels and disposal at permitted landfills which accept such asbestos wastes.
14. Presumed Asbestos Containing Material (PACM): TSI and surfacing material found in buildings constructed no later than 1980.
15. Surfacing Material: Any material that is sprayed, troweled-on or otherwise applied to surfaces. Includes materials such as acoustical plaster on ceilings and fireproofing materials on structural members, or other materials on surfaces for acoustical, fireproofing and other purposes.
16. Thermal System Insulation (TSI): Thermal insulation materials applied to pipes, fitting, boilers, breeching, tanks, ducts or other plumbing or mechanical components to prevent heat loss or gain.
17. Unclassified Asbestos Removal Operations: Activities involving the disturbance or removal of materials containing less than 1 percent asbestos based on PLM analysis of the homogeneous material layer by point count (≥ 400 points) including but not limited to ACCM. OSHA does not allow composite sampling for identification of materials with detectable asbestos less than one percent. Note: This category also applies to incidental removal of roofing materials (e.g. intact sealants and mastics) and asphalt coated pipeline, if certain work practices are adhered to.

18. Waste Generator Label: Waste Generator Label shall include the Generator's Name, ID Number, Address and Waste Manifest Number. The Hazardous Waste Generator for this project will be the Fort Ord Reuse Authority.
19. Wet Washing: The process of eliminating asbestos contamination from areas such as crawlspaces, tunnels, boiler rooms, etc., using wet washing methods (i.e. airless sprayers) to systematically wash down all surfaces within the affected area. "Wet Washing" should only be used after the affected area has first been fully cleaned using HEPA vacuums.

1.05 SUBMITTALS

- A. Refer to Section 01011 Summary of Hazardous Materials Work for submittal requirements applicable to this Section and the Contract submittal procedures section unless otherwise noted.

1.06 POSTINGS

- A. Prior to the commencement of any asbestos related work at the site, post required CAL/OSHA warning signs in and around the Work Area to comply with regulation.
- B. Post copies of the Contractor's Contractors State License Board (SCLB) license, Cal-OSHA registration certificate, temporary job-site notifications, local agency notifications, emergency exit diagram, emergency phone numbers, CAL/OSHA poster on worker's rights, and worker's compensation poster at proximate to the entrance to each Work Area or secure entry to area of building (s) to be abated.
- C. Contractor shall maintain at least one copy of the Contract Documents including project plans and hazardous material specifications, and a copy of 8 CCR 1529 asbestos on site and readily available for review by assigned workers and Authorized Visitors.
- D. Bilingual Worker Protection Procedures (English and Spanish) – To Be Posted in Clean Room.

1.07 SAFETY

- A. The Contractor shall take all necessary personal protective measures and provide sufficient safety training related to the following anticipated hazards, including but not limited to: airborne asbestos, lead, and organic vapors from solvent solvents and other chemical agents used; noise; heat stress; confined space; electrical (lockout and tag out); fall hazards (ladders, scaffolding, floor holes, roofs, etc.); high and ultra-high pressure water; power tools, eye hazards, and falling objects.
- B. Safety Compliance: The Contractor shall comply with this section and all laws, ordinances, rules, and regulations of federal, state, regional, and local authorities regarding removal,

handling, storing, transporting, and disposing of asbestos waste materials and conducting construction work. Where requirements of this section and any regulation or reference documents vary, the most stringent requirements shall apply. Submit matters of interpretation of standards to the appropriate administrative agency for resolution before starting work.

C. Emergency Precautions and Procedures

1. Establish emergency and fire exits from the Work Area. Stage at least two full sets of protective clothing and respirators at each emergency exit. A diagram of all emergency and fire exits must be prepared, and displayed in a conspicuous location in the clean room and/or entry to clean room.
2. Local medical emergency personnel, both ambulance crews and hospital emergency room staff, shall be notified prior to commencement of abatement operations as to the possibility of having to handle containment or injured workers, and shall be advised on safe decontamination.
3. Contractor's (on-the-job) Competent Person shall be prepared to administer first aid to injured personnel after decontamination. Seriously injured personnel shall be treated immediately or evacuated without delay for decontamination. When an injury occurs, the Contractor shall stop Work and implement fiber reduction techniques until the injured person has been removed from the Work Area.

1.08 SPECIAL PROVISIONS

- A. The Contractor shall hold the City, FORA, both the City's and FORA's Representatives and Agents including FORA's Environmental Consultant harmless for claims, damages, losses, and expenses, including attorney's fees, arising out of or resulting from the Contractor's asbestos or other hazardous materials work, asbestos and hazardous spills on the site or during transportation to the disposal site, or any condition resulting from the Contractor's work including but not limited to the Contractor's non-compliance with regulation or the Contract Documents.

PART 2 - PRODUCTS

2.01 GENERAL

- A. Submit manufacturer's product data and material safety data sheet (MSDS) for all products listed below per Section 02 10 11 requirements.

- B. The product submittal shall be limited to only those materials scheduled for use on this project. Do not submit data for products not scheduled for use.
- C. Submittals that are incomplete, disorganized, unreadable, or not project specific will be rejected.

2.02 PROTECTIVE COVERING (PLASTIC)

- A. Polyethylene sheets 6-mil and 4-mil sizes to minimize frequency of joints.

2.03 TAPE, ADHESIVE, SEALANTS

- A. Duct tape 2" or wider, or equal, capable of sealing joints of adjacent sheets of plastic sheets and for attachment of plastic sheet to finished or unfinished surfaces of dissimilar materials and capable of adhering under both dry and wet conditions, including use of amended water.
- B. Spray adhesive for sealing polyethylene to polyethylene. Adhesives used shall contain no methylene chloride compounds.
- C. Fire resistant sealants shall be compatible with concrete, metals, wood cable jacketing, etc. Sealant shall prevent fire, smoke, water and toxic fumes from penetrating through sealants. Sealant shall have flame spread, smoke and fuel contribution of zero, and shall be ASTM and UL rated for 3 hours for standard method of fire test for Fire Stop Systems.

2.04 PROTECTIVE PACKAGING

- A. Appropriately labeled 6-mil sealable polyethylene asbestos waste bags as a minimum.
- B. Appropriately labeled, impermeable asbestos waste drum containers with lids.
- C. Bilingual labels (English and Spanish) on containment glove bags, waste packages, contaminated material packages and other containers shall be in accordance with Cal/OSHA standards.

2.05 WARNING LABELS AND SIGNS

- A. As required by 29 CFR 1926.1101 and 29 CFR 1910.145.

2.06 SURFACTANT

- A. Surfactant or wetting agent product for amending water. Allowable includes wetting agents that are 50 percent polyoxyethylene ether and 50 percent polyethylene ester, or equivalent, at a concentration of one ounce per 5 gallons of water.

- B. Other manufactured wetting agent products specifically formulated for abatement work are acceptable.

2.07 ENCAPSULANTS

- A. After removal, use a tinted lock down encapsulant that allows visual verification of coverage. The encapsulant shall be applied in a fine mist application and shall not be allowed to pond at any time or for any duration.

2.08 SOLVENTS

- A. Solvents used for mastic removal or other cleaning shall be non-toxic, non-carcinogenic, non-flammable (flash point in excess of 200 degrees Fahrenheit), non-reactive with or damaging to materials it will come in contact with and approved for indoor use by regulatory agencies. Provide ventilation of Work Area as required by manufacturer. Vent exhaust to the exterior of the building and in a manner that will not result in adverse effects to adjacent facilities or public areas.

2.09 DIFFERENTIAL PRESSURE EQUIPMENT

- A. Provide Differential Pressure Equipment - High-efficiency particulate air (HEPA) filtration systems shall be equipped with filtration equipment in compliance with ANSI Z9.2, local exhaust ventilation. No air movement system or air filtering equipment shall discharge unfiltered air outside the Work Area. The differential pressure creating a negative pressure within the Work Area shall be maintained at 0.02 inches of water (-0.02") or greater and shall provide a minimum of four (4) air changes per hour during abatement.
- B. Provide Air Filtration Equipment with HEPA filtration system to cleanse air of particulate matter during abatement. Replace HEPA filters when filters become clogged with particulate matter. Provide enough air filtration devices within the work area to maintain fiber levels within the protection factors or maximum use concentrations of workers' respirators.
- C. All Differential Air Pressure Units and HEPA vacuums proposed for use onsite shall be tested onsite by an independent third party and certified to meet the HEPA standard of efficiency by the testing firm to ensure unprotected workers or Authorized Visitors outside Work Areas are not exposed airborne asbestos due to leaky or faulty equipment or filters. Submit copies of test certificates to the Environmental Consultant prior to startup of abatement activities.

2.10 PERSONAL PROTECTIVE EQUIPMENT

- A. Personal Protective Equipment shall comply with the requirements of 29 CFR 1910, Subpart I.

- B. Work clothes shall consist of disposable, full-body coveralls, head covers, boots, rubber gloves or equivalent in accordance with 29 CFR 1926.1101, and ANSI Z41. Sleeves at wrists and cuffs at ankles shall be secure. Disposable coveralls shall be made of a suitable tear resistant and dirt and particle penetration resistant fabric such as DuPont Tyvek or Kimberly Clark KleenGuard or an approved equal. No flimsy see-through coveralls are acceptable at this site.
- C. Eye protection and hard hats shall be available as required by applicable safety regulations and shall conform to ANSI 87.1 and 89.1.
- D. Provide Authorized Visitors with suitable protective clothing, headgear, eye protection, and footwear whenever they are required to enter Work Area.

2.11 RESPIRATORS

- A. Provide all workers, foremen, superintendents, authorized visitors, and inspectors personally issued and marked respiratory equipment approved by NIOSH. When respirators with disposable filters are employed, provide sufficient filters for replacement as recommended by respirator manufacturer(s). Selection of respirators shall be made according to the guidance of 29 CFR 1910 Subpart I; ANSI Z88.2; CGAI F7.1; EPA 560 OPTS-86.001; and Table I of this section. Selection of HEPA filters shall be made according to 42 CFR Part 84 (N100, R100, P100).
- B. When positive pressure supplied air Type "C" equipped with full face piece respirators are employed, the Air Supply System shall provide Type I Grade "D" breathing air in accordance with OSHA 29 CFR 1910 Subpart I and ANS Z88.2 and CGAI G7.1.
- C. The compressed Air system for Type "C" Respirators shall be high pressure (nominal 100 psi), with a compressor capacity to satisfy the respirator manufacturer's recommendations. The receiver shall have sufficient capacity to allow a 15 minute escape time for the respirator wearers in the event of compressor failure or malfunction. Type C supplied air respirators with HEPA filter disconnect may be used as an alternate to the 15 minute escape time required with event of compressor failure for Type C respirators. The Compressed Air System shall have compressor failure alarm, high temperature alarm, carbon monoxide alarm, and suitable in-line air purifying sorbent beds and filters to assure Grade "D" breathing air.
- D. The minimum respiratory protection required for this project is as follows:
 - 1. Use high efficiency powered air-purifying respirators (PAPRs) for all asbestos related work for Class I Asbestos Removal Work and/or where the Contractor's Exposure Assessment indicates the exposure level to employees will not exceed 1.0 fibers/cc.

2. If airborne fiber concentrations outside the respirator exceed 1.0 fibers/cc, use Type "C" respirators supplied-air, full face piece, Type "C" pressure demand or pressure demand with auxiliary positive pressure self-contained breathing apparatus.
3. When representative worker exposure levels are established, respirators presented in Table I that afford adequate protection for the maximum concentrations of airborne asbestos may be used, except for Class I Asbestos Work. The minimum respiratory protection for all Class I Asbestos Work, regardless of airborne concentrations, is PAPRs.
4. If respirators other than a Type "C" pressure-demand, supplied-air respirator, are provided, determine the exposure of each employee to airborne asbestos during each type of removal operation. Determine both the ceiling limit and the 8-hour, time-weighted average concentration of asbestos fibers to which each of the employees is exposed during each type of removal operation.
 - a. The Environmental Consultant will consider alternate respiratory protection systems proposed by the Contractor. Recent Negative Exposure Assessment (NEA) documentation must be provided by the Contractor demonstrating that asbestos levels during previous, comparable jobs were within the protection factors of the respirators to be used as outlined in Table I.

TABLE I		
Maximum Airborne Fiber Concentration Outside Respirator**	Protection Factor	Minimum Acceptable Respirator
0.1 fiber/cc	10	Half of full face mask and dual cartridge air purifying respirator with cartridges approved for asbestos and with high efficiency filters.*
1.0 fibers/cc	100	Powered air purifying respirator (full face piece) and with high efficiency filters.*
5.0 fibers/cc	1000	Supplied air respirators (SAR), full face piece, operated pressure demand (PD) mode.
Over 5.0 fibers/cc	50	Supplied air respirators, full face piece, pressure demand mode, equipped with an auxiliary positive pressure, self-contained breathing apparatus.

Disposable (single use respirators are not to be worn for protection against asbestos.

* Greater respiratory protection is always acceptable regardless of asbestos concentrations.

** For this project, respirators must be selected so that the fiber levels will not exceed 0.01 f/cc inside the respirator based on the assigned nominal protection factors and proper fitting and use of the selected respirator. Fibers levels in excess of 1.0 f/cc are unacceptable for this project and required initiation of additional feasible engineering and work practice controls to bring fiber levels down to levels allowing use of PAPR type respirators.

- d. When Type "C" respirators are not required according to the OSHA standard (29 CFR 1926.1101 or this specification, whichever is more stringent), provide workers with approved, permanent, personally-issued and marked respirators with replaceable filters. Provide sufficient quantity of filters jointly approved by NIOSH/MSHA for use in asbestos environments so that workers can change filters as required by manufacturer during the work day. Filters shall not be used any longer than one work day. Respirator filters shall be stored at job site in clean room and shall be totally protected from exposure to asbestos prior to their use.
- E. Breathing air compressors shall meet the requirements of 29 CFR 1910 Subpart I. Periodic inspection of the carbon monoxide monitor shall be evidenced. Documentation of adequacy of compressed air system/respiratory protection system shall be retained on site. Documentation shall include a list of compatible components with the maximum number and type of respirators that may be used with the system. Periodic testing of compressed air shall insure that systems provided air of sufficient quality.

PART 3 - EXECUTION

3.01 COORDINATION REQUIREMENTS

- A. Coordinate all hazardous material related work with non-hazardous work to prevent exposure to unprotected personnel at or near the work site.
- B. Phase hazardous material related work activities and non-hazardous work accordingly to prevent impacting air sample results outside Regulated Areas. The Contractor will be responsible for extra costs related to additional laboratory analyses or additional testing.
- C. Building access requirements and/or site restrictions shall be discussed at the pre-construction meeting.
- D. Coordinate timing of waste transport activities with FORA and the Environmental Consultant to allow for asbestos waste container checks, manifest review, and signing of the waste manifest by the authorized FORA representative or agent. The Contractor shall be aware that these activities may need to take place during times when it is most convenient to FORA.

- E. Coordinate with FORA and Seaside to shut down and isolation of power to the Work Area(s) and for obtaining any necessary temporary power and water.
- F. Coordinate and provide electric power to Environmental Consultant and the required number of power outlets needed inside and outside each Work Area for air monitoring equipment. These outlets shall be solely dedicated for the use of the Environmental Consultant.

3.02 PROJECT PROCEDURES

- A. Prior to the start of on-site work, the Contractor shall hold an on-site start-up safety meeting for all of his employees that addresses at least the following issues site specific for the project:
 - 1. Safety and health hazards;
 - 2. Procedures and work practices;
 - 3. Respiratory protection and instruction;
 - 4. Special conditions and work requirements.
- B. Worker Protection Procedures (Bilingual: English and Spanish) – To Be Posted in Clean Room.
 - 1. Provide authorized visitors with suitable protective clothing, headgear, eye protection, and footwear whenever they are required to enter Work Area.
 - 2. Each worker and authorized visitor shall, upon entering the job site: Remove street clothes in the clean-change room and put on a respirator and clean protective clothing before entering the equipment room or Work Area.
 - 3. Workers shall, each time they leave the Work Area: Remove gross contamination from clothing before leaving the Work Area; proceed to the equipment room and remove clothing except respirators; still wearing the respirator, proceed naked or with disposable underwear to the showers; clean the outside of the respirator with soap and water while showering; remove the respirator; thoroughly shampoo and wash themselves.
 - 4. Following showering and drying off, each worker shall proceed directly to the clean change room and dress in clean clothes at the end of the each day's work, or before eating, smoking, or drinking. Before re-entering the Work Area from the clean-change room, each worker and authorized visitor shall put on a clean respirator and shall dress in clean protective clothing.

5. Contaminated work footwear shall be stored in the equipment room when not in use in the Work Area. Upon completion of asbestos-related work, dispose of footwear as contaminated waste.
6. Workers removing waste containers from the equipment decontamination enclosure shall enter the Holding Area from outside wearing a respirator and dressed in clean disposable coveralls. No Worker shall use this system as a means to leave or enter the washroom or the Work Area.
7. In the event that workers outside the Regulated Area (or Work Area) are allowed or required to wear disposable coveralls, the color of disposable clothing worn outside the Work Area shall be different in color or markings from disposable clothing work inside Work Area. For example, this applies to workers conducting general removal or non-abatement related tasks in adjacent areas or buildings.
8. Workers shall not eat, drink, smoke, or chew gum or tobacco while in the Work Area.
9. Workers and Authorized Visitors with beards shall not enter the Work Area unless equipped with respiratory protection approved for use with beards (e.g. approved Hood or Helmet type respirators).

3.03 PREPARATION

A. General Requirements:

1. In the event there is live power to a building to undergo abatement, shut down electric power to the Work Area to the greatest extent possible. Consult with FORA and FORA's Representative before shutting down power. Provide adequate safe sources of temporary power and lighting per applicable electrical code requirements and ground-fault interrupter circuits for all electrical equipment used.
2. Install a Decontamination Enclosure System or equivalent prefabricated portable decontamination unit(s) as approved. This system will be the primary entrance and exit to the Work Area. Install separate waste handling and waste container decontamination rooms and with air locks for waste load-out at the buildings.
3. Seal off all other points of access to the Work Area with polyethylene sheeting sealed with tape.
4. Install Differential Pressure Equipment for all Class I and Class II Asbestos Removal Operations, and for Unclassified Asbestos Removal Operations (where specified) in accordance with the requirements herein.

5. Remove trash, garbage, dead animals, human and animal feces from all work areas to be abated prior to containment and Work Area set up.
 6. Remove movable objects and components that are not asbestos contaminated and decontaminate and remove contaminated furniture, appliances, and other objects or components that are cleanable.
 7. Pre-clean fixed objects and surfaces to remain within the proposed Work Areas, using HEPA filtered vacuum equipment and/or wet cleaning methods as appropriate, and enclose with protective barriers. Protective barriers will consist of plastic sheeting and other materials as appropriate.
 8. Clean the proposed Work Area(s) using HEPA filtered vacuum equipment and wet cleaning methods while keeping airborne fiber levels at or below 0.01 f/cc. Minimum PPE includes half face respirators with P100 filters, coveralls with hood and booties and gloves. Methods that raise dust, such as dry sweeping or vacuuming with equipment not equipped with HEPA filters shall not be used.
 9. Seal all remaining openings, including but limited to ducts, grills, diffusers, and any other penetrations of the Work Areas, with 2 layers of 6 mil polyethylene sheeting sealed with tape. Seal all joints of conduit, junction boxes, and ductwork with duct tape and plastic sheeting. Cover and protect during abatement.
 10. Establish and maintain emergency and fire exits from Work Areas at all times.
- B. Decontamination Enclosure System (General):
1. Construct decontamination enclosure system(s) with suitable framing for rigid doorways and walls. Walls and floor of decontamination enclosure system(s) shall be lined with 2 layers of 6 mil polyethylene sheeting sealed with duct tape.
 2. Access between contaminated and uncontaminated rooms or areas shall be through an airlock. Access between any two rooms within the decontamination enclosure system(s) shall be through a curtained doorway.
 3. Extra precautions shall be taken by the Contractor to prevent leaking of any kind from the Decontamination Enclosure System. The Contractor shall conduct inspections before, during and at the end of each work shift to ensure there is no standing water or leaks.
 4. The Decontamination Enclosure System shall be securable and lockable.

- C. Worker Decontamination Enclosure System: Construct a worker decontamination enclosure system contiguous to the Work Area consisting of three totally enclosed chambers including a clean room, a shower, and an equipment room.
- D. Equipment Decontamination Enclosure System:
 - 1. Provide or construct an equipment decontamination enclosure system consisting of three totally enclosed chambers including a washroom, a wet sponge area and a holding area. Use this system for waste double bagging, decontamination, and load out.
- E. Separation of Work Area from Non-Involved Building Areas:
 - 1. Separate parts of the building that are not involved in abatement activities from parts of the building that will undergo asbestos-related work by means of rigid airtight barriers.
 - a. Cover separation barriers with minimum of 2 layers of 6 mil plastic sheet, sealed with duct tape as specified on Work Area side.
 - b. Seal all penetration points to the work area by using minimum of 2 layers of 6 mil plastic sealed with duct tape.
- F. Maintenance of Enclosure Systems:
 - 1. Ensure that barriers and plastic linings are effectively sealed and taped. Repair damaged barriers and remedy defects immediately upon discovery.
 - 2. Visually inspect enclosures at the beginning of each work period.
 - 3. Use smoke methods to test effectiveness of barriers prior to implementing asbestos removal and as directed by FORA's Environmental Consultant.
- G. Asbestos abatement work shall not commence until:
 - 1. Submittals as required herein have been reviewed and approved in writing by FORA's Environmental Consultant.
 - 2. Arrangements have been made for disposal of waste at an acceptable site and there is a securable waste dumpster or bin present on-site lined with one layer of 6 mil polyethylene sheeting.
 - 3. The Contractor's Competent Person and the Environmental Consultant have inspected and approved the containment system for start of asbestos-related work and the "Pre-Abatement Visual Inspection Form" (Section 02 10 11 – Appendix G) is completed and signed by both parties.

4. Arrangements have been made for securing the Work Area and/or building or group of buildings within the project.

3.04 CLASS I ASBESTOS REMOVAL OPERATIONS

A. Work Area Preparation (General)

1. In addition to the General Requirements, as specified above, cover floor and wall surfaces with two independent layers of 6 mil polyethylene sheeting sealed with tape. For each layer, cover the floor first so that the polyethylene sheeting extends up the wall at least 12 inches, then cover the wall down to the floor level. An additional layer of polyethylene sheeting encompassing the entire floor of the work area shall be used during gross removal as a drop sheet.
2. Cover ceilings with one layer of 6 mil polyethylene sheeting where floor mastic is to be removed utilizing a chemical solvent and mechanical buffers with abrasive pads and/or utilizing bead or shot blasting and/or with any other type of mechanical removal of materials containing asbestos. The only time a ceiling cover will not be required for floor mastic removal is if the floor mastic is being removed manually or if the ceilings are to be removed and disposed of as a regulated asbestos containing material (RACM).
3. Differential pressure shall be installed, operating and able to maintain a negative pressure of 0.02 inches of water with a minimum of 4 air changes per hour during abatement.
4. Mini Containments: The use of mini-containments is permitted in small Work Areas if the disturbance or removal can be completely contained by the enclosure. Mini-containments shall be constructed out of a minimum of one layer of 6 mil polyethylene sheeting sealed with tape. The mini-containment shall have rigid framing for support. The enclosure shall have a decontamination enclosure system in accordance with the requirements herein or as approved by the Owner's Environmental Consultant. The containment shall be placed under negative pressure for the duration of work until final air clearance is obtained.

B. Abatement Procedures (General-Gross Removal):

1. Spray asbestos materials with amended water, using only spray equipment capable of dispensing a fine mist application. Saturate material without causing excess dripping or pooling. Spray materials and work area repeatedly during work process to control airborne fiber levels.

2. Remove saturated asbestos materials in small manageable sections. As they are removed, immediately place materials in six mil sealable plastic bags or appropriate containers labeled in accordance with 29 CFR 1910.1101 (g) (2) and 8 CCR 1529 (n) (3).
3. All waste put in plastic bags must be sealed using the “goose neck” technique by twisting the neck of the bag, bending it over and taping it with multiple wraps of tape. Clean external surfaces of containers thoroughly by wet sponging in the designated wet sponge area, which is part of decontamination enclosure system. Move containers to wash room, wet clean each container thoroughly, and move to holding area pending removal to uncontaminated areas. Ensure that containers are removed from the holding area by workers who have entered from un-contaminated areas dressed in clean coveralls. Ensure that workers do not enter from uncontaminated areas into the wash room or the Work Area.
4. After completion of asbestos-related work, surfaces from which asbestos has been removed shall be Wet Cleaned and/or Wet Sponged or cleaned by an equivalent method to remove all visible material and residue. During this work the surfaces being cleaned shall be kept damp. Do not allow water to pond at any time.
5. Remove outer layer of polyethylene sheeting (drop sheet) only. Clean all surfaces of the work area including remaining sheeting by use of damp-cleaning and HEPA filtered vacuuming.

C. Glovebag Technique:

1. Removal of asbestos-containing materials from piping may be accomplished using approved glovebag techniques in specified areas. In all cases, Glovebag operations shall be conducted within Regulated Areas with drop sheets at minimum.
2. Modifications or downgrading of the decontamination system in combination with use of a remote shower may be acceptable for this procedure if approved in writing by FORA’s Environmental Consultant. Contractor must submit their proposed worker decontamination enclosure system or area for approval.
3. After installation and smoke testing of glovebag(s), thoroughly wet material to be removed with amended water. Allow to soak in, then remove insulating material from piping. Insulation not to be removed shall be cut clean to form a new smooth edge a minimum of 6” back from the original end of the insulation. Thoroughly wash the inside of the bag, the piping surfaces and the tools.
4. Upon approval from FORA’s Environmental Consultant, encapsulate all surfaces inside the glovebag including the piping and ends of exposed insulation material. Evacuate bag with an approved HEPA vacuum; tie off trash area; remove tools from bag;

remove bag from pipe, folding inward the sides of the bag; then twist and tape the open end, the wand opening, and the vacuum opening.

5. Place glovebag directly into another six mil sealable plastic bag or appropriate container labeled in accordance with 8 CCR 1529 (n) (3). Seal the outer bag using the “goose neck” technique by twisting the neck of the bag, bending it over and taping it with multiple wraps of tape.

D. Cut, Wrap and Take Technique:

1. Removal of TSI from piping may be accomplished using the glove bag technique combined with approved Cut, Wrap, and Take Techniques in specified areas. In all cases, Cut, Wrap and Take Techniques shall be conducted within negative pressure enclosures unless the insulation is in substantially good condition.
2. Wrap pipe being removed with two layers of six mil polyethylene sheeting. Install glovebags at sections where the pipe will be cut and seal to polyethylene sheeting. Thoroughly wet material to be removed with amended water. Allow to soak in, then remove a section of insulation large enough to allow for cutting without disturbing the remaining asbestos insulation. Thoroughly wash the inside of the bag, the piping surfaces and the tools.

E. Asbestos Removal - Crawlspace, Tunnel, and Plenum Areas:

1. Crawlspace, Tunnel and Plenum areas shall not be accessed or opened until the decontamination enclosure system has been installed. At this point, access shall be restricted until Differential Pressure Units are installed, operating, and maintaining a negative pressure of at least 0.02 inches of water.
2. Seal off any openings within the crawlspace, tunnel and/or plenum areas with plastic and tape and/or foam prior to proceeding with any other activities in the Work Area.
3. Remove visible loose asbestos debris and contaminated soil and dispose of as ACM waste. Install a minimum of one layer of polyethylene sheeting as a drop sheet on the floor of the crawlspace or tunnel.
4. Remove pipe insulation in accordance with procedures described in the general abatement procedures.
5. Upon completion of removal, remove drop sheet and thoroughly HEPA vacuum all surfaces. Thoroughly wash down all surfaces in the crawlspace / tunnel / plenum areas. Contractor shall perform two complete cleanings of the crawlspace / tunnel / plenum areas prior to final visual inspection.

3.05 CLASS II ASBESTOS REMOVAL OPERATIONS

A. Work Area Preparation (Interior Areas):

1. Cover floor and other horizontal surfaces not scheduled for removal with two layers of 6 mil polyethylene sheeting extending at least 12 inches up all vertical surfaces (i.e., walls) and sealed with duct tape and spray adhesive (as necessary) to the wall surfaces. Cover wall surfaces with a minimum of one layer of 4 mil polyethylene sheeting from above the baseboard to the ceiling and seal with tape.
2. Cover ceilings with one layer of 6 mil polyethylene sheeting where noted and/or where floor mastic is to be removed utilizing a chemical solvent and mechanical buffers with abrasive pads and/or utilizing bead or shot blasting and/or with any other type of mechanical removal. The only time a ceiling cover will not be required for floor mastic removal is if the floor mastic is being removed manually or if the ceilings are to be removed as a regulated asbestos containing material (RACM).
3. In cases where Class I Asbestos Work and Class II Asbestos Work are scheduled to occur in the same Work Area, Contractor shall prepare the Work Area in accordance with the Class I Asbestos Work and sequence removal activities accordingly.

B. Work Area Preparation (Exterior Areas):

1. Cover ground and horizontal surfaces with one layer of 6 mil polyethylene sheeting extending at least five feet from wall surfaces to be abated and seal with duct tape and spray adhesive (as necessary).
2. Install barrier tape a minimum of ten feet away from the perimeter of Work Areas.

C. Work Procedures (General):

1. Remove asbestos-containing materials intact where possible using wet methods. All interior work shall be conducted within a negative pressure enclosure (NPE). As materials are removed, immediately place materials in six mil sealable plastic bags or appropriate containers labeled in accordance with 29 CFR 1910.1101 (g) (2) and 8 CCR 1529 (n) (3). Collect all dust and debris using vacuum cleaners equipped with HEPA filters. Modify methods where the use of water and/or HEPA vacuums could create an electrical hazard or other unsafe condition.

D. Gypsum Board/Joint Tape Compound/Texture Removal:

1. Protect adjacent wall and ceiling surfaces to remain in-place with a minimum of one layer of (4) mil polyethylene sheeting.

2. Phase gypsum board/joint tape compound/texture removal work such that the waste is not commingled with other asbestos wastes. Note: For texture on hard wall surfaces, remove by gross removal procedure using wet scraping and cleaning as indicated above.
 3. Mist the gypsum board /joint tape compound/texture continuously with amended water during removal. Remove gypsum board in larger sections or pieces where possible. There shall be a dedicated person applying mist at each point of removal. Clean up any standing water immediately.
 4. Place removed gypsum board /joint tape compound/texture in impervious containers with asbestos warning labels as it is removed. Complete Work Area clean-up when the gypsum board /joint tape compound removal is complete or at the end of the shift, whichever comes first.
- E. Removal of Asbestos Cement (AC) Piping, AC flues, & AC Panels:
1. Install one layer of 6 mil polyethylene sheeting in the area where the AC product is being removed. Polyethylene sheeting shall extend a minimum of five feet from the point of removal.
 2. Spray the AC product with amended water and keep wet at all times. Remove AC product in whole sections without breaking.
 3. Where possible, wrap two independent layers of 6 mil polyethylene sheeting sealed with tape around the AC product and remove and dispose of as a whole component.
 4. All resulting AC waste is to be bagged up as asbestos waste and removed from the Work Area prior to continuing hazardous material work.
 5. If AC products are to be removed by mechanical means, removal shall be completed utilizing removal procedures as specified for Class I work.
- F. Removal of Asbestos Fire Doors:
1. Remove asbestos fire doors without disturbing the concealed ACM core by removing hinge pins or hinges from doorframe or door along with any door stops or other door equipment.
 2. Wrap door two independent layers of 6 mil polyethylene sheeting sealed with tape around the asbestos fire doors and remove, label, and dispose of as a whole component.

G. Floor Tile Removal:

1. Wet floor tile with amended water. Do not allow water to pond.
2. Remove tile by prying with scrapers.
3. Take all necessary precautions to prevent breaking of tile keeping tile adequately wet at all times.
4. As tiles are removed, place them in properly labeled disposal containers and seal.
5. Under no circumstances shall material be subject to sanding, grinding, cutting or abrading.

H. Flooring Mastic Removal:

1. General: Contractor shall not begin any mastic removal from the floor slab until the floor tile has been completely removed, containerized and the floor surface is free of loose dust and debris.
2. Floor tile mastic may be removed by solvent using a mechanical buffer, bead blasting, or by ultra-high-pressure water blast technique. The latter method is preferred due to general efficiency, speed, and completeness of removal.
3. For solvent removal, install wall protective plastic sheeting to a minimum of 4 feet height. Use an approved mastic removing solvent that is nonflammable, non-toxic, non-hazardous and either low odor or odorless. Apply mastic removing solvents in accordance with manufacturers recommended procedures. Clean-up slurry as mastic is being removed, and place it in properly labeled Hazardous Asbestos Waste disposal containers. Add absorbent material as necessary to avoid any liquid wastes.
4. Use of an approved portable shot abrasive "Bead Blaster" system that strips, cleans, and etches the floor, if used, shall follow the manufacturer's recommended procedures. Usage of this system will require a variance as a dry "removal" method from the local air quality board and shall require additional control measures including an adapted misting system and polyethylene sheeting on ceilings. Treat removed mastic and spent blast abrasive as friable hazardous asbestos waste for disposal.
5. Use of ultra-high pressure water blasting using a system the captures the water and filter the water to remove the mastic as a sludge. Removal water must be ultimately re-filtered down to and through a one micron pore filter prior to discharge into a sanitary or industrial sewer a system when allow by local agency. Resulting removal mastic solids and sludge shall be disposed of as a hazardous asbestos waste.

6. In cases where the asbestos containing floor mastic is adhered to a wood and/or non-ACM contaminated felt underlayment, remove the wood and/or felt underlayment in whole sections and dispose of as an asbestos waste.
- I. Removal of Building Components (i.e. Gas Lines, Piping, HVAC Equipment, etc.) with Asbestos Containing Paints/Coatings/Sealants/Mastics:
 1. Install one layer of 6 mil polyethylene sheeting in the area where the building component with asbestos containing paints/coatings/sealants/mastics is being removed. Polyethylene sheeting shall extend a minimum of five feet from the point of removal.
 2. Spray the building component with amended water and keep wet at all times. Remove building component with asbestos containing paints/coatings/sealants/mastics in whole sections without breaking.
 3. Where possible, wrap two independent layers of 6 mil polyethylene sheeting sealed with tape around the building component with asbestos containing paints/coatings/sealants/mastics and remove and dispose of as a whole component.
 4. All resulting asbestos waste is to be bagged up as asbestos waste and removed from the Work Area prior to continuing hazardous material work.
 5. If the building component with asbestos containing paints/coatings/sealants/mastics is to be removed by mechanical means, removal shall be completed utilizing glove bag procedures as specified in 3.04 of this section for Class I work.
 - J. Removal of Asbestos-Containing Materials by Mechanical Removal
 1. Removal of asbestos containing surfaces by mechanical removal shall be performed within negative pressure enclosures.
 2. All mechanical removal equipment and systems shall be approved by the Owner's Consultant. Such equipment includes but is not limited to needle guns, abrasive wheels, and roto-peen equipment.
 3. All power tools shall be designed and equipped with HEPA-filtered exhaust systems.
 4. The Contractor shall submit a separate work plan for containment of fugitive dust and debris emissions.
 - K. Removal of Roofing Materials

1. Establish a regulated area consisting of barriers/barrier type and warning signs at least 10 feet from the point of removal. The edge of the roof can be considered such a barrier if sufficient controls have been established to prevent loss or spillage of roofing materials over the side.
 2. Establish a regulated area for roof access. This will be the point of entry/exit to the regulated area. For entering/exiting the roof area from the exterior of the building, the Contractor may use a remote decontamination system.
 3. Remove roofing materials in small manageable sections using wet methods and promptly place in properly labeled six-mil plastic waste bags (double bagged). Removal shall be completed at minimum 18 inches on either side of the asbestos roof material being removed.
 4. All asbestos removal waste bags shall be removed from the roof at the end of each work day.
 5. In no case shall waste disposal containers be dropped or thrown. All waste disposal containers shall be handled in a careful manner to prevent a spill and resulting fiber release of airborne asbestos.
 6. Acceptable clearance criteria for roofing removal shall be no visible three-dimension residue at removal locations.
 7. All non-friable roofing waste shall be disposed of as a non-hazardous asbestos waste.
- L. Removal of Construction Mastics, Sealants, Paints, Coatings, Caulking and Glazing Compounds:
1. Establish a regulated area consisting of barriers/barrier type and warning signs at least 5 feet from the point of removal.
 2. Establish a Regulated Area entry area for access. This will be the point of entry/exit to the Regulated Area. For entering/exiting the Work Area from the exterior of the building, the Contractor may use a decontamination area with a bucket system to be used in conjunction with a remote personnel decontamination system.
 3. Remove mastics, paints, sealants, coatings, caulking and window glazing compounds in small manageable sections using wet methods and promptly place in properly labeled waste containers. Remove construction materials as necessary to access caulking materials.

4. In no case shall waste disposal containers be dropped or thrown. All asbestos containing waste disposal containers shall be handled in a careful manner to prevent a spill and resulting fiber release of airborne asbestos.
5. Acceptable clearance criteria for mastics, sealants, paints, caulking and glazing compounds removal shall be no visible three-dimension residue at removal locations.
6. All non-friable mastics, caulking and glazing compound wastes removed intact shall be disposed of as a non-hazardous California asbestos waste. Where materials such as window glazing compounds become friable during removal, they must be treated as asbestos hazardous wastes.
7. If asbestos containing mastics, sealants, paints, coatings, caulking and glazing compounds are to be removed by mechanical means, removal shall be completed utilizing removal procedures as specified in 3.04 of this section for Class I work

3.06 EXTENSION OF WORK AREA

- A. If a Critical Barrier is breached and/or a spill occurs outside the Work Area or Regulated Area, the Contractor shall extend the work area to include the affected area. The Contractor shall take all precautions to prevent the spread of asbestos debris and/or asbestos fibers during extension of the Work Area. Containment of the affected area shall be constructed in the same manner required for that class of asbestos work associated with the spill or containment breach.
- B. FORA's Environmental Consultant will determine the extent of the Work Area boundaries.

3.07 DECONTAMINATION OF WORK AREA

- A. Clean all surfaces within the Work Area using wet methods and HEPA vacuum equipment. Floor and wall surfaces shall be free of any visible asbestos material, debris and dust.
- B. The Contractor's Competent Person shall perform a complete visual inspection of the Work Area under adequate lighting to ensure that the Work Area is free of visible asbestos material, debris, dust, waste bags or containers, and unnecessary equipment. The Competent Person shall ensure that additional cleaning is completed if the area is not acceptably clean. The Contractor's request for inspection will be recognized upon receipt of a completed and signed copy of the Final Visual and Clearance Certification Form (Section 02 10 11 – Appendix H). No inspections will be conducted without a completed and signed copy of the Final Visual and Clearance Certification Form (Section 01011 – Appendix H) at least 24 hours in advance or as agreed upon at the pre-start meeting.
- C. Upon successful completion of final visual inspection by the Owner's Environmental Consultant, spray substrate(s) with encapsulant compatible with finish materials.

Encapsulant should be applied using airless spray equipment as specified by the manufacturer.

- D. The Owner's Environmental Consultant shall conduct the final air clearance testing interior containment Work Areas after a minimum 4 hour wait period. Final clearance air sampling and analysis shall be conducted in accordance with NIOSH 7400 or 40 CFR 763 with number of samples and analytical method at the discretion of FORA and FORA's Environmental Consultant. After written notification from the Environmental Consultant accepting decontamination of the Work Area (Section 01011 – Appendix H), remove inner plastic layer isolation barriers and proceed with any remaining repairs or refinish work and reestablishment of objects and systems as specified.

3.08 WASTE HANDLING AND DISPOSAL

- A. Prior to start of any removal work, obtain from FORA the EPA waste generator number for the site and the name and contact information for the FORA representative who will be signing the hazardous and non-hazardous waste manifests.
- B. Asbestos waste shall be stored inside secure lockable labeled waste bins within a secured fenced area pending transportation for disposal. Asbestos Waste must be taken from the Work Area directly to a securable waste dumpster via leak tight carts by the end of each work day or shift.
- C. Waste Manifests: Each time Hazardous Asbestos Waste and Non-Hazardous Asbestos Waste is removed from the site the Contractor is responsible for submitting the generator (yellow) and the DTSC (blue) copies to FORA's Representative and copies to FORA's Environmental Consultant. For Hazardous Asbestos Waste, complete and submit a copy of the Land Disposal Restriction Form.
- D. The sealed asbestos containers shall be delivered to Contractor's pre-designated approved hazardous waste site for burial; in accordance with Title 22, CCR, EPA guidelines and 40 CFR 61.156 and local Air Pollution Control District Regulations. Contractor shall be responsible for safe handling and transportation of hazardous waste generated by this Contract to the designated Hazardous Waste Site.
- E. Notify the Owner 48 hours in advance of the time when contaminated materials are to be removed from the site and coordinated for review and signing of asbestos waste manifests prior to scheduled pick up.

3.9 AIR MONITORING

- A. Area Air Monitoring:

1. Throughout the abatement process, compliance area air monitoring will be conducted by FORA's Environmental Consultant to ensure work is done in conformance with fiber concentration limits of these Specifications.
 2. If area air monitoring results outside the Work Area are in excess of 0.01 f/cc or background air samples, whichever is greater, Contractor shall make changes in work procedures to assure compliance with minimum standards. At a minimum, Contractor shall stop all work and clean the affected area to the extent necessary as determined by FORA's Environmental Consultant. Contractor shall be responsible for all costs associated with air fiber counts outside the Work Area including asbestos air analysis by transmission electron microscopy (TEM).
- B. Contractor shall submit results of Contractor's daily personnel exposure monitoring within 24 hours of the sampling or according to a schedule approved by FORA at the pre-start meeting. Personnel air monitoring shall not exceed the levels recommended for the type of respiratory equipment in use and associated protection factors required to achieve an air concentration within the respirator face piece of less than 0.01 f/cc.
- C. FORA's Environmental Consultant will conduct the final air clearance testing after a minimum four hour wait period. Final clearance air sampling and analysis shall be in accordance with NIOSH Method 7400 or 40 CFR 763 at the discretion of FORA and/or FORA's Environmental Consultant. The number of clearance samples will be greater than one and typically up to five per containment area depending on size of removal area and type and extent of asbestos material removed. The first set of clearance samples will be collected and analyzed at FORA's Expense.
- D. If an unacceptable final air clearance is obtained, the Work Area decontamination for the entire area shall be considered incomplete and re-cleaning must be repeated in accordance with the procedures outlined herein. The Contractor shall also be responsible for all costs associated with such failure such as Consultant fees and laboratory costs.

3.10 CLEAN-UP

- A. Maintain a clean project site during and upon completion of work of this section. Project site housekeeping and site cleaning shall be in accordance with the General Conditions of the contract.

3.11 PROJECT CLOSEOUT

- A. Contractor shall provide all outstanding submittal information to FORA's Environmental Consultant within 10 working days from the completion of abatement work. The City and FORA reserve the right to withhold final payment to the Contractor until all required submittal information is received and approved by FORA's Environmental Consultant.



2984 Teagarden Street, San Leandro, CA 94577

END OF SECTION 02 82 00

S201-ITB1, Volume 2 – Lead-Related Stabilization and Removal Specification: 02 90 01

1.01 SECTION INCLUDES

- A. This section specifies requirements for lead-related removal and abatement including but not limited to:
 - 1. Submittals
 - 2. Contractor's Monitoring Program
 - 3. Products
 - 4. Lead-Related Work Execution including:
 - 5. Work area preparation
 - 6. Worker protection and decontamination
 - a. Removal of lead containing components
 - b. Removal of lead containing ceramic tile
 - c. Removal of lead containing coatings by mechanical removal
 - d. Removal of lead containing coatings by abrasive blasting
 - e. Removal of lead by high pressure water blasting
 - f. Lead Based Paint (LBP)/Lead Containing Paint (LCP) and coatings stabilization
 - g. Cleaning and decontamination
 - h. Clearance inspection
 - i. Waste characterization and disposal
 - 7. Stop work orders
 - 8. Project closeout

1.02 REGULATIONS

- A. The Contractor shall comply with the requirements of the current issue of the following regulations and guidelines governing lead abatement and disposal and other applicable Federal, State, and Local Government regulations. The regulations listed herein are incorporated by reference.
 - 1. Code of Federal Regulations (CFR):
 - a. 29 CFR 1926, Construction Standards
 - b. 29 CFR 1926.62, Lead in Construction

- c. 40 CFR Part 50.12, Ambient Air Quality Standard for Lead
- d. 40 CFR Parts 261, 265 and 268, Hazardous Waste Management
- e. 40 CFR Part 745 Lead; Identification of Dangerous Levels of Lead
- f. 49 CFR Part 172, 173, 178, 179, Hazardous Material Transportation

2. California Code of Regulations:

- a. 8 CCR Division 1, Chapter 4, Subchapter 4, Construction Safety Orders
- b. 8 CCR 1532.1, Lead in Construction
- c. 8 CCR 5144, Respiratory Protection
- d. 22 CCR Division 4.5, Environmental Health Standards for Management of Hazardous Waste
- e. 17 CCR Division 1, Chapter 8, Accreditation, Certification and Work Practices for Lead-Based Paint and Lead Hazards.

B. Refer to Instructions to Bidders, Section 9.26, for Prevailing Wage Regulations.

1.03 RELATED DOCUMENTS

- A. Contract documents including hazardous material-related plans and specifications and all other project construction documents. Refer to Section 02 10 11, Summary of Hazardous Materials Work, Article 1.04 Related Documents for a more detailed listing.
- B. Refer to 02 41 00 Building Removal, Section 3.07, for Environmental Requirements.

1.04 DEFINITIONS

- A. In addition to the definitions in Section 02 10 11 Summary of Hazardous Materials

Work, the following definitions are specific to work of this section:

1. Lead Hazard Abatement -- Any set of measures designed to reduce or eliminate lead hazards.
2. Certified Lead Supervisor -- An individual who is responsible for implementing lead-related construction work and enforcing work practices that ensure worker safety in residential or public buildings and who has received a certificate or an interim certificate from the California Department of Public Health (CDPH) as a certified lead supervisor.
3. Certified Lead Worker -- An individual who performs lead-related construction work under the direction of a certified lead supervisor and has received a certificate from the CDPH as a certified lead worker.
4. Certificate -- "Certificate" means the document issued by the CDPH to an individual who meets the requirements for certification as described in sections 35083, 35085, 35087, 35089, or 35091 of Title 17.

5. Clearance Inspection -- "Clearance Inspection" for this project means an on-site limited visual investigation for completeness of work including final cleanup of all visible paint chips and debris. After removal, additional clearance testing of soils may be conducted to determine whether lead-related construction, abatement, and/or building removal have been completed without contamination of the site above background soil lead levels.
6. Component -- A structural element or fixture, including but not limited to a wall, floor, ceiling, door, window, molding, trim, trestle, tank, stair, railing, cabinet, gutter, or downspout.
7. CDPH -- "CDPH" means the California Department of Public Health.
8. Deteriorated Paint -- Paint or surface coating that is cracking, chalking, flaking, chipping, peeling, non-intact, or otherwise separating from a building component or surface. Note: Deteriorated paint on interior and exterior of each building must be removed prior to Building Removal to minimize risk of site contamination.
9. Hazardous Waste -- Lead debris shall be classified as hazardous due to the characteristic of toxicity, as determined by testing in accordance with the California Code of Regulations, Title 22, Division 4, Chapter 30, Article 11. Any substance(s) listed in Article 11 Section 66699 at concentrations greater than their listed Soluble Threshold Limit Concentration (STLC) or Total Threshold Limit Concentration (TTLC) may need to be further characterized by the Toxicity Characteristic Leaching Procedure (TCLP) in accordance with 40 CFR 261 and other tests prior to disposal as a hazardous waste. Note: whole painted components or architectural debris with intact LBP is not typically expected to exceed hazardous waste criteria and may be evaluated by a consideration of the ratio of all materials in the waste to the lead content of the associated paint.
10. Intact LBP Components -- LBP components removed substantially intact with LBP firmly adhering to the surface. Also referred to as architectural components or debris with intact paint.
11. Lead-Based Paint (LBP) -- The concentration of lead in paint or other surface coatings in the amount of or equal to 0.5% lead by weight when analyzed by atomic absorption spectroscopy (AAS) or Inductively coupled plasma atomic emission spectroscopy (ICP-AES) or 1.0 milligrams of lead per square centimeter (mg/cm²) as determined by X-ray fluorescence (XRF) testing, or as identified by specification.
12. Lead-Containing Paint (LCP) Related Waste -- Paint chips, vacuum dust and debris, used cleaning articles, waste water, plastic sheets and other disposable items which were used during the lead abatement, LCP paint stabilization, or lead-related removal process and as a result are considered lead contaminated waste or assumed hazardous lead waste pending further characterization.

13. Lead-Containing Paint (LCP)/Surface Coatings – Any paint or other surface coating with detectable levels of lead by XRF or when analyzed by wet chemistry (e.g. AAS or ICP-AES). Lead must be assumed present in any paint or coating in buildings constructed prior to 1978 unless proven otherwise by Environmental Lead Laboratory Accreditation Program (ELLAP) accredited laboratory testing.
14. Lead-Contaminated Dust -- The amount of lead equal to, or in excess of, 40 micrograms per square foot ($\mu\text{g}/\text{ft}^2$) for floor surfaces, 250 $\mu\text{g}/\text{ft}^2$ for horizontal window sills and 400 $\mu\text{g}/\text{ft}^2$ for window wells (troughs) and exterior horizontal surfaces.
15. Lead-Contaminated Soil -- Bare soil that contains an amount of lead equal to or in excess of 400 parts per million (ppm) in children’s play areas and 1,000 ppm in all other areas. In addition, for this project, soil lead contamination above the project pre-start soil levels for the site is considered Lead-Contaminated Soil and is the responsibility of the Contactor to remediate to background levels or lower.
16. Lead Hazard -- Deteriorated lead-based paint or lead-containing surface/coating material, lead contaminated dust, lead contaminated soil, disturbing lead-based paint or lead-containing surfaces/coating materials or presumed lead-containing surfaces without containment, or any other nuisance which results in environmental lead contamination.
17. Lead Hazard Abatement – Special abatement activities undertaken with the specific intent to eliminate or reduce existing lead hazards as defined herein. Not to be confused with abatement controls on normal lead-related construction work in construction areas with restricted access to the general public. In this latter case, lead is present in or on construction materials and is impacted by the work but is not the focus of the work to be undertaken.
18. Lead-Related Construction Work -- Any construction, alteration, painting, removal, salvage, renovation, repair, or maintenance of any building, including preparation, surface preparation, and cleanup that, by disturbing lead-containing materials, surfaces or soil, may result in lead exposure to workers, the environment, and/or the public.
19. Lead Stabilization – For this project, the process of controlled surface preparation using containment and wet methods and/or high-efficiency particulate air (HEPA) vacuuming to prepare a deteriorated LCP surface for removal to minimize the potential for lead contamination of project grounds and soils above background levels. Lead-Stabilization involves removal of loose peeling, flaking and deteriorated LCP paint from interior and exterior building surfaces and properly characterizing and disposing of the resulting lead hazardous wastes.

20. Presumed Lead-Based Paint -- Any paint or surface coating affixed to a component in or on a structure, excluding paint or surface coating affixed to a component in or on a structure constructed on or after January 1, 1978 or a school constructed on or after January 1, 1993 unless proven otherwise by laboratory testing.
21. Qualified Person -- The individual identified by the Contractor to be responsible for conducting air sampling, calibration of air sampling pumps, evaluating sampling results, and conducting respirator fit tests.
22. Removal -- All herein specified procedures necessary to remove and clean-up LCP, LBP, and lead-containing surface coatings, lead-contaminated dust, and lead-contaminated soil from the designated project buildings and areas and to properly containerize, characterize, and dispose of these materials at an acceptable site in accordance with Federal, State and Local Regulations.
23. Visually Clean -- Free of visible dust, paint chips, dirt, debris, or films removable by vacuuming or wet cleaning methods specified. For outside soil or ground cover areas, visually clean shall mean free of construction and paint debris, chips or dust distinguishable from the initial soil or ground conditions. Note: Prior to start of abatement and removal activities the surfaces and grounds within 10 feet of each building's foot print are to be pre-cleaned to visual standards.

1.05 HAZARD COMMUNICATION

- A. The Contractor shall refer to Specification Section 02 10 11 Summary of Hazardous Materials Work for a list of all known or assumed hazardous materials including lead, asbestos, polychlorinated biphenyls (PCBs) and other materials. All lead-related work shall be conducted with full consideration of any other hazardous materials impacted and the required protective measures and controls.

1.06 SUBMITTALS AND NOTICES

- A. Refer to Section 02 10 11 Summary of Hazardous Materials Work for submittal requirements applicable to this Section and the Contact submittal procedures section unless otherwise noted.

1.07 ENVIRONMENTAL CONSULTANT

- A. Fort Ord Reuse Authority's (FORA) Environmental Consultant is authorized to provide compliance observation and monitoring, testing, and technical oversight services for the lead-related construction, removal, stabilization, and abatement work of this project without limitation.

1.08 CONTRACTOR'S COMPLIANCE AND QUALITY ASSURANCE

- A. The Contractor shall have a Competent Person who is a CDPH Certified Lead

Supervisor on site at all times while lead-related work or Lead/LBP abatement and paint stabilization is in progress. The Contractor's Competent Person shall communicate and coordinate with the Environmental Consultant with regard to work schedules, inspections, daily submittals, and compliance issues.

B. The Contractor's Competent Person shall:

1. Ensure the Contractor's compliance with the specification and regulation.
2. Conduct worker exposure monitoring using a Qualified Person and provide results to the Environmental Consultant.
3. Pre-inspect Work Areas for compliance and completion prior to notifying the Environmental Consultant of the Work Area's readiness for inspection.
4. Accompany the Environmental Consultant during Work Area pre-start and clearance inspections.
5. Ensure the Contractor's workers have current and valid medical, blood-lead test, training, and respirator fit test records and provide copies of all new or updated records to the Environmental Consultant for approval before assigning the workers to any work within Work Areas.
6. Take timely and appropriate corrective actions to ensure compliance with the abatement plans and specifications and to eliminate unsafe, unhealthful, and environmentally unsound work practices regardless of whether or not they are brought to the Contractor's attention by the Environmental Consultant.
7. Conduct waste stream profiling and waste characterization of each waste stream for lead and adhere by the results for the characterization of waste for proper packaging, labeling, storage, transportation and disposal of waste.
8. Provide completed daily project documentation to the Environmental Consultant at the end of each work day. This includes daily rosters, entry/exit logs, foreman reports, and any other project information.

C. Contractor to meet the following experience requirements:

1. Prior experience in prior experience in hazardous material abatement in preparation for building removal of multi-story military concrete structures,
2. Prior experience in hazardous material abatement in preparation for

building removal under the jurisdiction of MBUAPCD

3. Prior experience in hazardous material abatement in preparation for building removal projects of \$3 million plus.

1.09 SPECIAL PROVISIONS

- A. The Contractor shall hold the FORA, FORA's Representatives, Agents and Environmental Consultant harmless for claims, damages, losses, and expenses, including attorney's fees, arising out of or resulting from the Contractor's lead or other hazardous materials work, lead and hazardous materials spills on the site or while in transport to the disposal site, or any other condition resulting from the Contractor's non-compliance with regulation or the Contract Documents

PART 2 - PRODUCTS

2.01 PROTECTIVE COVERING

- A. Polyethylene sheets, of 6 mil thickness in size (dimensions), to minimize the frequency of joints.

2.02 CLEANERS

- A. For clean-up and decontamination, a lead-specific wash solution shall be used. Alternative cleaning and decontamination agents shall be subject to approval by the Environmental Consultant and FORA.

2.03 TAPE

- A. Duct tape (or approved equivalent) two (2) inches or wider, capable of sealing joints of adjacent sheets of polyethylene sheeting and for attachment of polyethylene sheeting to finished or unfinished surfaces of dissimilar materials and capable of adhering under both dry and wet conditions.

2.04 SPRAY ADHESIVE

- A. Provide spray adhesive in aerosol cans which is specifically formulated to stick to sheet polyethylene.

2.05 DISPOSAL CONTAINERS

- A. Provide six (6) mil thick polyethylene sheeting, six (6) mil leak-tight polyethylene bags and other impervious containers as required by applicable regulations. All waste shall be labeled as hazardous or potentially hazardous waste unless proven otherwise by

appropriate sampling and laboratory analysis.

- B. All hazardous waste shipping containers shall meet applicable Department of Transportation (DOT) requirements.

2.06 WARNING SIGNS AND LABELS

- A. Caution Signs: To be a minimum of 20 x 14 inches and include the phrase "Caution Lead Hazard, Keep Out Unless Authorized" in minimum 2-inch high letters. These shall be posted at each approach to each lead Work Area.
- C. CAL/OSHA Lead Warning Posters: "Warning - Lead Work Area, Poison, No Smoking or Eating" shall be posted at the entrance to each Work Area.
- D. Labels: Hazardous waste shall be labeled according to Federal, State and Local regulations including but not limited to the California Code of Regulations, Title 22, Chapter 30 and the U.S. Department of Transportation 49 CFR Parts 172, 173, 178 and 179.

2.07 PERSONAL PROTECTIVE EQUIPMENT

- A. Personal protective equipment (PPE) shall comply with the requirements of 8 CCR 1532.1 Lead.
- B. Minimum protective clothing and equipment shall consist of fire-retardant, disposable, full-body coveralls, disposable boots, gloves, or equivalent in accordance with ANSI Z41. Sleeves at wrists and cuffs at ankles shall be secure. Disposal coveralls shall be constructed of a tear resistant dust impervious fabric such as DuPont Tyvek, Kimberly Clark KleenGuard, or equivalent. No flimsy, see-through coveralls are acceptable.
- C. Eye protection and hard hats shall be available and worn as required by applicable safety regulations and shall conform to ANSI 87.1 and ANSI 89.1. Eye protection shall be worn during work. Hard hats shall be worn during all exterior work.
- D. The Contractor shall provide Authorized Visitors with suitable disposable protective clothing, headgear, respirators, and footwear whenever authorized visitors are required to enter the Work Area. Up to an average of ten sets per day of suitable personal protective equipment shall be made available for authorized visitors.
- E. All disposable clothing worn during each work shift shall be removed prior to exiting the Work Area and shall be properly segregated and placed in containers for proper waste characterization. The Contractor shall bear full responsibility for additional costs associated with waste profiling and disposal if wastes are not properly

segregated.

2.08 RESPIRATORS

- A. Provide workers with personally-issued respiratory equipment approved by The National Institute for Occupational Safety and Health (NIOSH) and suitable for the lead exposure level in the Work Area. Where respirators with disposable filters are employed, provide sufficient filters for replacement as required by the worker or applicable regulation. HEPA Type P100 cartridges shall be used with respirators. Each respirator shall be washed whenever the worker wearing it showers, or at least daily prior to storage. The following general conditions shall apply to respirator use:
1. All respirators used must be certified by NIOSH and a respirator program shall be established and implemented.
 2. The minimum respiratory protection required for this project, unless otherwise specified in writing by the Environmental Consultant shall be a half- face negative pressure air purifying respirator. Otherwise, the respirators worn shall be selected based on measured or reasonably expected airborne concentrations of lead as follows:
 - a. Half-face negative pressure air purifying respirator: up to 0.5 mg/m³
 - b. Powered air purifying respirator: up to 2.5 mg/m³
 - c. Type C supplied air respirator full face piece pressure demand mode: up to 100 mg/m³.

Note: Disposable respirators are not acceptable at any time. It is always permissible to upgrade to a more protective type of respirator.

1. During all segments of lead removal, stabilization, removal, and clean-up activities, respirator usage shall be required of all persons within the designated Work Areas at all times, regardless of airborne lead concentrations.
- B. The Contractor is responsible for determination of airborne lead concentration levels for the Contractor's personnel and for providing and enforcing use of appropriate personnel respirator protection based upon airborne lead concentrations and this specification.
- C. Respirators shall not be removed inside the Work Area. Workers shall proceed to the designated washing area and clean the external surface of the respirator body before removing the respirator.

2.09 TOOLS AND EQUIPMENT

- A. Provide suitable tools for the removal of Lead containing materials and contamination including HEPA vacuums, ground fault interrupters (GFIs), ladders, scaffold, garden sprayers and airless sprayers. All tools and equipment brought onsite shall be clean and free of lead and other hazardous material contaminants. HEPA vacuums shall be labeled with a lead warning label and dedicated to Lead-related construction work to prevent commingling of lead wastes with asbestos and other wastes.
- B. Provide and operate the suitable personnel decontamination equipment including at minimum portable handwashing stations and, depending on type of operation and airborne lead levels, remote on-site showers are acceptable but handwashing stations should be close to lead Work Areas.

PART 3 - EXECUTION

3.01 GENERAL

- A. All designated lead related work shall be conducted in accordance with applicable regulation, this specification section, and as indicated in Section 02 10 11. The Contractor shall adhere to the requirements as set forth for the lead-related construction methods chosen and approved.
- B. Posting of Lead Hazard Warning and Safety Information:
 - 1. Post signs at all approaches to the Work Area entrance to read "Caution Lead Hazard - Keep Out Unless Authorized." In addition, post the CAL-OSHA Lead Hazard Warning Poster at the immediate Work Area entrance.
 - 2. A list of phone numbers for the local hospital and for emergency response, the local fire department, a representative of the Contractor who may be reached 24 hours a day, the Contractor's main office, FORA's Representative and Environmental Consultant and any other professional consultants directly involved in the project.

3.02 PREPARATION FOR INTERIOR PAINT STABILIZATION WORK

- A. Move all non-fixed objects out of the Work Area(s).
- B. General rubbish and biological waste materials are required to have already been removed by the Contactor prior to this pre-cleaning.
- C. Pre-clean entire floor area and all horizontal surfaces inside the Work Area using HEPA vacuums and wet methods. Note:
- D. Cover all non-moveable objects within five (5) feet of the Work Area with six (6) mil polyethylene sheeting and seal with duct tape.

- E. Cover all floors within the Work Area with at least one layer of six (6) mil polyethylene sheeting and seal with duct tape.
- F. Install air lock flaps on all doorways into Work Area with plastic sheeting to form curtained doorways. Doors secured from the inside need not be sealed.
- G. Provide, at minimum, 30 foot candle illumination lighting to the Work Area.
- H. Install lead caution signage at each approach to the Work Area and lead warning signage just outside each Work Area entry/exit point.
- I. Complete any additional preparation work required by the specific component abatement/lead-related construction work requirements specified elsewhere in this section.
- J. When Work Area preparation is complete, notify the Environmental Consultant and request an inspection. No lead stabilization work is to proceed in any Work Area until that Work Area preparation has been inspected and approved by the Environmental Consultant.

3.03 PREPARATION FOR EXTERIOR STABILIZATION WORK

- A. Cordon off the Work Area extending at a minimum of 10 feet horizontally beyond the area of work with barrier tape and warning signs as specified herein.
- B. Pre-clean visible suspect lead-based paint dust and debris around and under areas where deteriorated LBP, LCP or lead-containing coatings will be removed. Use HEPA vacuums and wet methods to perform this cleaning which shall include, at minimum, the designated Work Area.
- C. Cover ground and horizontal surfaces of Work Area (area within barrier tape) with a minimum of one layer of six (6) mil polyethylene sheeting. Secure the plastic on the building foundation as possible. Horizontal surfaces include scaffolding and/or other work platforms. Extend the plastic from the foundation to 10 feet beyond the Work Area. Seal all seams with tape and secure plastic to prevent undesired movement.
- D. Where elevated Lead-containing components are likely to generate airborne dust or paint chips, devise a suitable containment to control such dust and prevent dispersal by wind. Exterior removal which generates Lead dust and debris shall not be attempted when winds or air currents (i.e., greater than 15 mph) prevent containment of such waste material within the designated Work Area. To conduct exterior removal under windy conditions, the Contractor shall implement special, safe and effective countermeasures to ensure containment of Lead dust and debris. These countermeasures include but are not limited to protective shrouds or mini-containments on work platforms.

- E. Provide a designated entry/exit point to exterior Work Areas suitable for workers to properly decontaminate and exit from the Work Area as specified herein. Install lead caution and warning signage as specified above.
- F. Complete any additional preparation work required for the specific abatement method to be used.
- G. Notify the Environmental Consultant when the Work Area is ready for inspection. Lead paint stabilization and other lead-related work shall not proceed until the Environmental Consultant has checked and approved Work Area preparations.

3.04 WORKER PROTECTION AND DECONTAMINATION PROCEDURES

- A. The Contractor shall use only workers medically qualified and trained for lead work and respirator usage.
 - 1. Medically-qualified shall mean that the worker has had an occupational medical exam for lead exposure and respirator usage within 12 months of abatement start-up and at any time during abatement or lead-related construction work. The contents of the medical exam must be in conformance with 8 CCR 1532.1 and must include a blood-lead test within 30 days of starting work on the project. At no time shall the abatement worker exceed six months between each blood-lead testing.
 - 2. Each lead abatement worker shall have successfully completed at least 24 hours of formal documented training in lead hazards and lead abatement methods and be a current CDPH Certified Lead Worker. Non-abatement workers performing lead related construction work shall have documented lead hazard communication training in accordance with 8 CCR 1532.1.
 - 3. The Contractor's Competent Person shall have received at least 40 hours of formal training in lead hazards and lead abatement.
 - 4. The Contractor's Supervisor(s) and workers shall be certified through the Department of Health Services (DHS) lead accreditation program for lead-related construction. Copies of each employee's certification shall be provided.
 - 5. The Contractor shall ensure that no worker is allowed onsite to perform lead-related work until the Environmental Consultant has received and approved of that worker's medical, training and fit testing certifications.
- B. Each worker and Authorized Visitor shall, upon entering the job site, enter the

designated clean change room and remove street clothes, put on an inner reusable or disposable coverall and work shoes and then put on an outer set of full body disposable coveralls, booties or shoe covers, respirator with HEPA filters, and gloves before entering the Work Area.

- C. Each worker and Authorized Visitor shall HEPA vacuum contamination from protective clothing and then remove shoe covers before leaving one Work Area for another Work Area inside the same Work Area unless the Work Areas have been interconnected with a secured plastic sheet at least three feet wide.
- D. When exiting an interior or exterior Work Area and leaving the specific building worked on, proceed to the designated area for unsuiting and remove outer protective clothing and equipment. Dispose of outer protective clothing as suspect Lead waste. Proceed to a designated decontamination area, remove and clean the respirator and store in a clean container. Wash hands and face and proceed to clean change area to re-suit for the next area. At end of day, workers are to proceed to the nearby or remote on-site shower system and shower off all lead-related contamination.
- E. At the end of the work day, all workers are to do the following in addition to those procedures described above: Place disposable outer garments and shoe covers in separate labeled waste containers dedicated to PPE for proper waste characterization; place reusable clothing for laundering in a closed container, clean protective gear including respirator, shower or wash hands and face at minimum, and put on clean street clothes in the clean room area.
- F. All tools and equipment shall be decontaminated by HEPA vacuuming and wet wiping prior to being taken out of the Work Area. Tools and equipment with inaccessible internals shall be externally wet-wiped, bagged and sealed prior to being removed from the Work Area.
- G. Workers shall not eat, drink, smoke, or chew gum or tobacco at the work site within 20 feet of any Work Area as specified by the Environmental Consultant.
- H. Provide and post the decontamination and work procedures to be followed by workers in the equipment area and in the clean area.
- I. Each worker shall have a final medical blood-lead laboratory test within one week of job completion and before engaging in other lead related work.

3.05 REMOVAL OF LEAD CONTAINING COMPONENTS

- A. Remove any associated non-Lead containing hardware, items, or construction interferences (electrical and telephone utilities, conduit, piping, etc.) as required by the Contract and store in construction area until final disposition is determined by the

FORA's Representative.

- B. Remove Lead containing components designated for salvage (if applicable). Scrape painted seam at edge of each component with utility knife or blade tool and remove any exposed accessible fasteners. Spray the affected surfaces of the Lead containing component being removed lightly with a fine mist of amended water.
- C. Using appropriate tools, begin to remove the lead containing component by prying first behind nailing locations and/or removing accessible fasteners.
- D. Each component shall be carefully lowered to the ground, not dropped or thrown. Clean up dust and debris as removal proceeds.

3.06 REMOVAL OF LEAD CONTAINING CERAMIC TILE

- A. Removal ceramic tiles with lead containing glaze.
- B. Remove any associated non-Lead containing hardware or construction interferences (casework, fixtures, partitions, utilities etc.) as required for disposal unless otherwise directed.
- C. Remove Lead containing ceramic tile where specified herein and by the Contract. Spray the affected surfaces being removed lightly with a fine mist of amended water.
- D. Special precautionary controls shall be used as necessary to prevent Lead dust or debris from being carried or blown out of the controlled area.
- E. Using appropriate tools, begin to remove the Lead containing ceramic tile starting from the highest point. Continue removing the Lead containing ceramic tile being careful to prevent lead dust or ceramic tile debris from being carried or blown out of the controlled area. Ensure as the ceramic tile is removed, it is sprayed lightly with a fine mist of amended water to keep dust levels down. Take necessary precautions to avoid damage to adjoining walls and/or associated surfaces.
- F. Clean up dust and debris as removal proceeds.
- G. Once removed, remove or flatten any protruding materials and place the ceramic tile debris in two six (6) mil polyethylene bags, seal with duct tape, wet-wipe and transfer to secure waste storage for waste characterization.
- H. HEPA vacuums and wet-wiping shall be used to ensure any resulting Lead dust and ceramic tile debris have been cleaned up from horizontal surfaces and polyethylene sheeting prior to moving ladders, scaffolding, man-lifts or other working platforms to the next Work Area to be abated.

3.07 REMOVAL OF LEAD CONTAINING SURFACES BY MECHANICAL REMOVAL

- A. Removal of lead containing surfaces by mechanical removal shall be performed within negative pressure enclosures unless the equipment is HEPA vacuum assisted dust control shrouding covering working parts or edges.
- B. All mechanical removal equipment and systems shall be approved by the Environmental Consultant. Such equipment includes but is not limited to needle guns, abrasive wheels, and roto-peen equipment.
- C. All power tools shall be designed and equipped with properly shrouded HEPA-filtered exhaust systems.
- D. The Contractor shall submit a separate work plan for containment of fugitive dust and debris emissions.
- E. Work Area preparation and lead coating removal shall be in accordance with approved work plan.

3.08 REMOVAL OF LEAD CONTAINING COATINGS BY ABRASIVE BLASTING METHODS

- A. All abrasive blasting equipment shall be of the vacublast type with effective capture and control of dust and debris using a built-in local HEPA Exhaust System or wet blast method such as "Turbo" blast. Alternative abrasive blasting systems are subject to approval by the Environmental Consultant.
- B. The Contractor shall submit a separate work plan for containment of fugitive dust and debris emissions. The plan shall include all equipment and products to be used.
- C. The Contractor shall be responsible for all permits and notices required for full compliance with local air pollution control district rules and regulations.
- D. No work shall proceed until an approved abrasive blasting containment plan is approved and in place.

3.09 REMOVAL OF LBP & LCP COATINGS BY WATER BLASTING

- A. Removal of loose and deteriorated paint by high pressure water blasting or ultrahigh pressure water blasting is acceptable for stabilization and ultrahigh pressure water jetting is acceptable for intact paint removal if properly conducted and controlled.
- B. Protect interior and exterior surfaces with plastic sheeting and tarping to protect plastic sheeting.

- C. Contain all blast water to prevent run off and contamination of horizontal surfaces and grounds. Water shall be filtered and tested prior to disposal based on test results and local agency rules.
- D. Characterize and dispose of resulting removal solids and sludge as hazardous lead waste.

3.10 LBP AND LCP STABILIZATION

- A. Prepare the Work Area as specified herein for lead stabilization.
- B. Water blasting or jetting may be used with proper controls as indicated above.
- C. Manual Surface Preparation - Remove all loose, flaking, peeling and/or deteriorated paint using wet methods and prepare the surface within the work area as follows:
 - 1. Lightly moisten exposed Lead containing surfaces to be prepared;
 - 2. Wet-scrape and/or wet-sand surfaces as necessary to remove all loose and deteriorated paint or glazing compounds to obtain a like new surface with any remaining coating soundly bonded to the substrate;
 - 3. Periodically re-moisten as necessary to control airborne dust;
 - 4. HEPA vacuum and wet-wipe frequently to prevent accumulation and spread of lead-containing dust and debris;
 - 5. Promptly dispose of all spent cleaning materials in labeled impervious containers;
 - 6. Surface preparation is complete when the surface is sound, smooth, clean, and free of loose and deteriorated paint.
- D. Surface Preparation/Paint Stabilization Clean-up
 - 1. Upon completion of surface preparation, wet-scraping, and/or wet sanding, clean and decontaminate the entire Work Area using procedures outlined herein;
 - 2. Decontaminate all tools and equipment before removing them from the Work Area. Seal or bag up such equipment for transfer to the next Work Area or operation;
 - 3. Visually inspect prepared surfaces and the cleaned Work Area prior to applying any paints or coatings to ensure all loose paint, dust and debris has been cleaned up and the surface is properly prepared for painting.

- E. Clean and decontaminate the entire Work Area and notify the Environmental Consultant to arrange for a visual clearance inspection. The Work Area containments shall not be removed until the Contractor has been notified by the Environmental Consultant of a satisfactory preliminary visual inspection result.
- F. Remove containments and conduct final cleaning and decontamination of entire Work Area. Notify Consultant at least 24 hours in advance to arrange for final clearance inspection and testing (where required).

3.11 CLEANING AND DECONTAMINATION OF WORK AREAS

- A. Daily Clean-up: Perform the following clean-up procedures daily.
 - 1. Clean Work Areas, after hand pick-up of large debris, using HEPA vacuuming and/or wet-wiping until each Work Area is free of visible paint chips, loose dust and debris as verified by the Environmental Consultant.
 - 2. Wet debris with a fine mist of water and collect material. All material to be properly segregated, bagged in 6-mil plastic bags, sealed, and moved to a designated, secure waste storage area for waste characterization.
 - 3. At the end of each work day the Environmental Consultant and the Contractor's Competent Person shall inspect work performed that day to ensure the work has been completed and no dust or residue remains on the areas removed and/or in the Work Area.
- B. Final Clean-up and Decontamination: At completion of abatement and stabilization operations perform cleaning as follows:
 - 1. Remove all visible dust and debris as specified above.
 - 2. Disassemble and remove containment barriers at each Work Area location after cleaning as specified above. Place polyethylene sheeting and tape into waste bags and remove to the temporary waste storage area.
 - 3. Remove six (6) mil polyethylene sheeting on immovable objects and floors (where present) after HEPA vacuuming and wet-wiping. Place polyethylene sheeting and waste rags in segregated six (6) mil plastic bags, seal and store in a designated, secure waste storage area for waste characterization.

4. If the wet vacuuming method is used, waste water shall be contained and disposed of properly after waste characterization testing.
5. The cleaning procedure used shall prevent spread of contamination and effectively clean surfaces while producing minimal waste.
6. All tools and equipment shall be sealed in six (6) mil plastic bags after being decontaminated using a high phosphate wash and wet-wiping prior exiting the Work Area.
7. Liquid removal and cleaning wastes shall be filtered prior to containerizing for temporary storage pending hazardous waste characterization. Filter systems shall be able to remove particulates two microns and larger in diameter. Permits for disposal of water in sanitary or industrial sewers, if required, are the responsibility of the Contractor.

3.12 FINAL CLEARANCE INSPECTION AND TESTING

A. Interior Paint Stabilization Clearance Inspection.

1. Interior Clearance of interior Work Areas shall be by visual inspection conducted by FORA's Environmental Consultant. No clearance wipe sampling will be required for pre-removal lead stabilization work.
2. After the final clean-up, the Contractor shall perform a complete visual inspection of the Work Area under adequate lighting to ensure the Work Area is free from visible debris, dust, waste bags, containers, and unnecessary equipment prior to notifying the Environmental Consultant that the Work Area is ready for visual clearance inspection.
3. If the Work Area is not visibly clean, as determined by the Environmental Consultant, the Contractor shall re-clean and decontaminate as described herein at his own cost until the work area passes inspection.
4. A Work Area shall be considered completed and cleared only after all areas within the Work Area have met the above criteria.
5. If a Work Area fails the clearance criteria specified above, the Contractor shall clean the entire Work Area at no additional cost nor increase to the contract sum and shall be responsible for associated additional Environmental Consultant fees.

B. Exterior Paint Stabilization Clearance Inspection.

1. After the final clean-up by the Contractor, the Environmental Consultant shall conduct

- a visual inspection to ensure that all visible dust and debris has been properly removed.
2. The Contractor must provide the Environmental Consultant at least 8 hours' notice prior to scheduling final inspections.
 3. If the results of the inspection are unsatisfactory, the Contractor shall re-clean and decontaminate the Work Area prior to requesting another inspection by the Environmental Consultant.
 4. If the results of the final visual inspection are satisfactory the exterior Work Area shall be released for unrestricted access.
- C. Upon completion of all interior and exterior LBP/LCP paint stabilization work and all required hazardous materials removal work (e. g. asbestos, PCB's, UW, lead paint stabilization, etc.), the Contactor may proceed with building removal if all other pre-removal requirements of the Contract have be met and completed.
- D. Removal of painted building materials is considered lead-related removal and will be conducted using wet methods to the extent feasible for dust control and using methods that minimize potential for lead contamination of the site.
- E. Unless noted otherwise in the Contact, foundation concrete will be segregated from painted concrete and other painted building materials of the building superstructure.
- F. Removal debris to be disposed of shall be profiled and evaluated for waste characteristics associated with lead contamination and transported to the appropriately permitted waste disposal site based on those results.
- G. Unpainted concrete free of asbestos residue may be crushed for re-use on site if and as indicated in the Contract. Stockpile in an area designated or approved by FORA.
- H. Clean site of all visible removal debris including any resulting paint chips prior to any other site preparation, back filling or grading.
- I. FORA's Environmental Consultant may conduct a post-removal surficial soil sampling of top six inches of soil within ten feet of each buildings foot print for comparison with pre-start results. Acceptable results are results indicating that each analyte is below background pre-start levels taking into consideration the analytical error of the laboratory's analytical method.

3.19 LEAD CONTAMINATION OF BUILDING ENVIRONMENT

- A. In the event that removed paint dust or debris is not properly contained within the Work Area and thereby escapes, bypasses or penetrates established barriers, the Contractor shall stop work immediately, notify the Environmental Consultant immediately, and commence clean-up and decontamination procedures as described herein or as directed by the Environmental Consultant.
- B. For soil contamination, the Contractor shall remove all visible signs of paint dust and debris and, at minimum, the upper six inches of soil in the area contaminated above the pre-abatement composite soil sample results and at least ten feet beyond the building foot print in each direction.
 - 1. Successful completion of soil decontamination shall be subject to evaluation by sampling at the discretion of FORA and FORA's Environmental Consultant.
 - 2. Soil sample(s) with lead concentrations below pre-abatement composite soil sample results shall be the criteria for completion of soil clean-up and decontamination.
 - 3. The Contractor shall be responsible for all costs associated with disposal of any debris and contaminated soil, including waste characterization testing.

3.20 WASTE STORAGE, SEGREGATION, AND CHARACTERIZATION

- A. The Contractor shall provide for secure onsite temporary storage of Lead related waste. Waste storage location, equipment, containers and methods are subject to prior approval by the FORA and FORA's Environmental Consultant.
- B. Paint stabilization and removal debris must be evaluated to determine waste characteristics by the Contractor prior to disposal. Intact lead containing components, all lead-related waste streams and waste categories shall be considered hazardous until proven otherwise. The Contractor shall be responsible for segregating waste into the following categories and conducting appropriate waste testing for lead:
 - 1. Paint (LBP & LCP) chips, dust and debris, HEPA vacuum waste, and used cleaning materials. The Contractor shall handle, store and dispose of these items as a hazardous lead waste. Conduct characterization testing to verify status as Resource Conservation and Recovery Act (RCRA) and California Lead Hazardous Wastes.
 - 2. Plastic sheeting and tape. Except for plastic sheeting from chemical removal areas, these used items, if properly cleaned, should be non-hazardous. However, they shall be considered hazardous unless proven otherwise by lead waste testing.
 - 3. Disposable Protective Clothing and Equipment (PPE). Disposable work clothes and other items potentially contaminated with LBP or lead, if properly cleaned, should be non-hazardous. However, they shall be considered hazardous unless proven otherwise

by lead waste testing.

4. General Removal Debris. Debris consisting of painted building walls, ceiling, doors, windows, and other lead-containing paint coated architectural components shall be considered hazardous pending laboratory results. The Contractor may create separate building removal waste streams but each must be profiled and evaluated for waste characteristics prior to transport to an appropriately classed permitted waste disposal site.
 5. Ceramic tile debris. Ceramic tile debris with lead levels greater than 1.0 mg/cm² shall be considered hazardous pending laboratory results.
- C. Each lead-related waste produced shall be placed in properly segregated, labeled and sealed, impervious containers or bins.
- D. All waste containers, bags, and packaged waste shall be stored in a designated, secure, locked waste storage area and be labeled "PENDING ANALYSIS" with the following information:
1. Waste Category
 2. Date Accumulated
 3. Name, address of Site Owner
 4. Origin of waste
- F. HEPA vacuum and wet-wipe the exterior of all waste containers prior to removing them from the Work Area to the designated storage area.
- G. All lead-related waste shall be considered hazardous until waste characterization has been performed under the California Code of Regulations, Title 22.
- H. Each category of waste, shall be tested and characterized by the Contractor using the following lead waste testing protocols and lead hazardous waste criteria:
1. Cal-EPA testing protocol:

	<u>Criteria</u>
a. Total Threshold Limit Concentration (TTL):	1000 ppm
b. Soluble Threshold Limit Concentration (STLC):	5 mg/l
 2. Federal-EPA testing protocol (RCRA):

a. Toxicity Characteristic Leaching Procedure (TCLP):	5 mg/l
---	--------

- I. All waste testing will be conducted by the Contractor and shall be subject to direct observation and review by the Environmental Consultant. At minimum, a TTLC shall be performed on each suspect waste stream. A minimum of one representative four-point composite sample shall be collected from each different waste stream. Based on the testing protocols, any waste greater than or equal to five (5) mg/l lead using STLC or TCLP tests or any waste greater than or equal to 1,000 ppm lead using the TTLC test shall be considered a hazardous waste.
- J. When the TTLC is less than 50 ppm lead, no further testing is required for that waste category sampled. A minimum of four samples will be taken to represent each category of waste generated. It will be the responsibility of the Contractor to ensure representative samples are taken from each category of segregated waste.
- K. The Contractor shall package, store, handle, transport and dispose of each category of waste generated based on the testing results obtained by the Contractor and reviewed by the Environmental Consultant. Where landfills have more stringent requirements, the Contractor shall be responsible for all additional disposal costs. The proposed landfill shall be subject to approval by the Environmental Consultant.
- L. Upon verbal request of the Environmental Consultant, the Contractor shall collect samples of Lead-related waste. The Contractor shall collect samples within full view and presence of the Environmental Consultant. Samples taken may entail cutting and removing sections of a component and clean-up of any resulting dust or debris.
- M. The cost of all waste characterization or waste profiling required by the approved landfill will be the responsibility of the Contractor.
- N. In the event that the Environmental Consultant has determined that waste is not properly segregated, additional waste testing may be conducted of the mixed waste stream. The Contractor shall be responsible for the costs associated with this additional testing.
- O. The Contractor shall bear full responsibility for additional costs associated with waste disposal and characterization if waste is not properly segregated as required herein.

3.21 HAZARDOUS WASTE DISPOSAL:

- A. **Site Storage and Handling:** The Contractor shall pay strict attention to the requirements of 40 CFR 262 and 265 and Title 22, Chapter 30 for the onsite handling of debris, with special attention given to the time of storage, amount of material stored at any one time, use of proper containers, and personnel training. All waste shall be stored in secure, locked, labeled, sealed impervious containers and not placed on the unprotected ground. All containers shall be shielded adequately to prevent dispersion of the debris by wind or rain and shall be labeled as hazardous waste. Any evidence of improper storage shall be cause

- for immediate shutdown of the project until a corrective action is taken.
- B. Transportation and Disposal of Waste:
1. The Contractor shall arrange to have the Lead-related waste and debris transported from the site in accordance with the requirements of 40 CFR 263 and 264, and disposed of properly in accordance with 40 CFR 268, GISO 8 CCR Articles 40 and 41, 49 CFR Parts 172, 173, 178, and 179 and Title 22, Chapter 30, Articles 5, 6, 6.5 and 8.
 2. The Contractor shall submit to the FORA representative and Environmental Consultant the Name, Class, and EPA I.D. Number of the waste disposal site(s) to be used for each waste category which has been determined by testing to exceed the hazardous waste thresholds listed herein.
 3. Where Lead related construction debris is to be disposed of as a non-hazardous, a waste shipping manifest is still required and a copy shall be provided to the FORA Representative and Environmental Consultant.
 4. The Contractor shall prepare waste shipping manifests for review by the FORA and FORA's Environmental Consultant well in advance of planned pick up. Upon waste or material pickup by the selected waste transporter, manifests shall be signed by FORA's Representative and copies retained to verify that all steps of the handling and disposal process have been completed properly.
 5. Copies of the landfill weight tickets shall be provided to the FORA and Environmental Consultant to verify the amount of waste disposed of at that site. The Contractor shall be responsible for all costs associated with transportation and disposal of all wastes generated at the result of this work.
- C. No waste characterized as hazardous waste shall be stored onsite for more than 90 days prior to being properly transported for disposal.
- D. All equipment, materials, and hazardous waste generated on this project must be removed offsite to their proper locations by the Contractor within seven (7) calendar days from successful abatement and removal completion and receipt of final clearance inspection and testing results for lead related work.
- E. Containers to be loaded for transportation from the storage area must be removed by workers who have entered from uncontaminated areas, dressed in clean coveralls.

3.22 STOP WORK ORDERS

- A. The Environmental Consultant has the authority to stop work in accordance with Section 02 10 11 Article 1.15. Examples of such conditions that might result in a work stoppage

include but are not limited to:

1. Uncontrolled visible emissions which escape the established Work Area or breach physical protective barriers within the Work Area; and/or,
2. Ambient airborne levels of lead measured outside the fenced construction area at more than 4.5 micrograms per cubic meters of air (mg/m^3) of lead averaged over an eight hour work period or the equivalent of 1.5 (mg/m^3) for any 24 hour period.
3. Airborne dust levels exceeding the Cal/OSHA Action level of 30 micrograms per cubic meter of air outside the Regulated Area or building removal zone where unprotected personnel or Authorized Visitors may be present.
4. Unsecured Waste Storage Area and/or improper containment of abatement or lead paint stabilization waste.

3.23 PROJECT CLOSEOUT

- A. Prior to approval of final payment request, the Contractor must provide the following information:
 1. Copies of hazardous waste manifests, profile sheets and weight tickets for all hazardous wastes and manifests and weight tickets for non-hazardous wastes or recyclables consisting of architectural debris with intact paint.
- B. All non-project building or structures damaged during this work must be restored to their original condition except those surfaces scheduled for removal as part of this project.

**END OF S201-ITB1 VOLUME 2
LEAD-RELATED STABILIZATION AND REMOVAL**

S201-ITB2, Volume 2 - SECTION 31 14 00– STOCKPILING

PART 1 – GENERAL

1.01 RELATED DOCUMENTS

- A. Construction Drawings, Technical Specifications, Addenda, and Contact Agreement, including any Addenda, including other Division 1 Specification Sections, apply to this Section.

1.02 SECTION INCLUDES

- A. Requirements for stockpiling construction wastes.

1.03 RELATED SECTIONS

- A. SECTION 01 41 50 - HEALTH AND SAFETY REQUIREMENTS
- B. SECTION 01 57 00 - TEMPORARY CONTROLS
- C. SECTION 01 33 00 - SUBMITTAL PROCEDURES
- D. SECTION 31 10 00 - SITE CLEARING
- E. SECTION 31 20 00 - EARTH MOVING

1.04 SUMMARY

- A. Construction of lined stockpile areas for all potential impacted soil or waste materials requiring stockpiling.
- B. Movement, drying and monitoring of stockpiled materials.
- C. Management of wastes and soils in stockpiles, including temporary environmental controls and covers.
- D. Relocation or construction of additional stockpile areas to accommodate stockpiled materials or as necessary by the Contractor's phasing of the Work.
- E. Installation of erosion and sediment control measures around stockpile area.
- F. Demolition of stockpile areas including linings and any impacted soils underlying the stockpiles as a result of the failure of any such linings.

1.05 SUBMITTALS

- A. All submittals shall be prepared in accordance with Section 01 33 00 Submittal Procedures.
- B. Stockpiling plans showing locations and details for stockpiles
- C. Stockpile Management Plan, including phasing, equipment, storm water controls, odor and dust management, and demolition.
- D. Contractor shall obtain any necessary permits for stockpiling of construction materials.

PART 2 – PRODUCTS

2.01 GEOMEMBRANE LINERS AND COVERS

- A. Geomembrane liners and covers shall be either high density polyethylene (HDPE) or linear low density polyethylene (LLDPE) with a minimum thickness of 10mm.

2.02 EQUIPMENT

A. General

1. Equipment used in performing the Work shall be in good working order and shall be operated in accordance with manufacturer's instructions and recommendations.
2. All the equipment used in management of stockpiles shall be cleaned properly prior to leaving stockpile areas.
3. Any soils contaminated by discharge of fluids from leaky or faulty equipment or stockpile environmental control and containment systems shall be removed and properly disposed. The contaminated area shall be backfilled with clean soil, at no additional cost to the project.

PART 3 – EXECUTION

3.01 STOCKPILE LINER DESIGN

- A. Minimum Stockpile Liner Design shall include use of geomembrane to protect against contamination of underlying soil. Geomembrane shall be either high density polyethylene (HDPE) or linear lowdensity polyethylene (LLDPE) as described in Part 2 and shall be anchored in anchor trenches outside the limits of the stockpile footprint.
- B. Stockpile liners shall be placed on a graded surface in a manner to control and contain storm water run-off from a 100-year 24-hour storm event.

3.02 STORM WATER MANAGEMENT

- A. Storm water management includes handling, storage and disposal of surface water generated within stockpile areas during construction.
- B. Storm water that comes into contact with stockpiles shall be discharged according to the Storm Water Pollution Prevention Plan (SWPPP).
- C. All stockpiled materials shall be placed and stored in accordance with the requirements of the Storm Water Pollution Prevention Plan.
- D. Contractor shall take measures to prevent run off of storm water and waste, including but not limited to use of berms, tarps and grading.

3.03 STOCKPILE CONSTRUCTION AND MANAGEMENT

- A. No materials shall be stockpiled on site for more than 5 days unless approved by FORA.

- B. Storage of wastes within stockpiles shall be minimized to the extent possible. After the Contractor has identified the disposition of stockpiled materials, the Contractor shall load and haul the materials to the final disposal location within five (5) working days.
- C. Contractor shall maintain stockpiles until the stockpiled material is transported off site for disposal or is classified and accepted by the Engineer to be reused as fill. Import granular fill stockpiles shall be maintained and kept segregated from other materials until the material is placed in designated excavation areas.
- D. Management of stockpiles, including location within the work area, phasing of their construction, and abandonment shall be at the sole discretion of the Contractor, provided adequate measures for drainage, storm water control and environmental protection are implemented as approved by the Engineer.
- E. Stockpiles shall be located such that they will not interfere with other operations or designated traffic routes. Separate stockpiles shall be maintained for materials as directed by the Engineer.
- F. The ground surface at stockpile locations shall be cleared, grubbed and proof-rolled prior to stockpiling. The ground surface at the stockpile location following disposal shall be smoothed and leveled. Stockpiles shall be protected from contamination that may affect the suitability of material for backfill.
- G. Stockpiles shall be constructed at slopes no steeper than 2:1 (horizontal: vertical) and graded to drain.
- H. Stockpiles shall not be located close to the edge of steep slopes, where the stockpiles could cause slope instability as determined by the Engineer.
- I. Stockpiled wastes shall be covered at the end of each day or prior to a predicted wind or rain event.

END OF SECTION 31 14 00

S201-ITB2, Volume 2 - 31 40 00 – SHEETING SHORING AND BRACING

PART 1 - GENERAL

1.01 RELATED DOCUMENTS

- A. Construction Drawings, Technical Specifications, Addenda, and Contact Agreement, including any Addenda, including other Division 1 Specification Sections, apply to this Section.

1.02 SECTION INCLUDES

- A. Sheeting and shoring for basement and utility excavations.

1.03 RELATED SECTIONS

- A. Section 01 11 00 – Summary of Work
- B. Section 01 33 30 – Submittals
- C. Section 01 51 00 – Temporary Utilities
- D. Section 02 41 16 – Demolition and Removal

1.04 DESCRIPTION

- A. Provide protective installation consisting of shores, wales, braces, posts, piling, sheeting, anchorages and fastenings, both temporary and permanent, for accomplishment and protection of work including, but not limited to, the following:
 - 1. Temporary shoring and sheeting for removal of basement, buried pipelines, and other structure excavations.

1.05 SUBMITTALS

- A. Sheet and Shoring Plan. The Contractor, prior to beginning any trench or structure excavation 5 feet deep or over shall submit to the District's Representative and shall be in receipt of the FORA Construction Manager written acceptance of the Contractor's detailed plan showing design of all shoring, bracing, sloping of the sides of excavation, or other provisions for worker protection against the hazard of caving ground during the excavation of trenches or structures. Submit complete calculations of the sheeting system including sheeting size, wales, rakers, anchor system, struts, earth anchors, anchor piles, tie rods or any other components pertinent to the design prior to the start of any work involving sheeting and bracing. The plans shall be prepared by a Civil or Structural Engineer licensed in the State of California.
 - 1. As a part of the plan, a note shall be included stating that the registered civil or structural engineer certifies that the plan complies with the CALOSHA Construction Safety Orders. Each copy of the plan shall have an original seal and "wet" signature of a Civil or Structural Engineer registered in the State of California across the seal.

2. If the Contractor's trench protection system includes the use of a shield, the shield design shall be approved by the Division of Industrial Safety. Structural details shall indicate the maximum pressure the shield can safely withstand, the trench configuration and supporting calculations indicating the maximum pressure against the shield.
3. The plan shall include surcharge loads for nearby embankments and structures, for spoil banks, and for construction equipment and other construction loadings. The plan shall indicate for all trench conditions the minimum horizontal distances from the side of the trench at its top to the near side of the surcharge loads.
4. The Sheeting and Shoring Plan is submitted for record purposes only. The acceptance of the plan only indicates the submission of plan and does not imply approval of the plan or relieve registered engineer responsibility for the plan. Nothing contained in the section shall be construed as relieving the Contractor of the full responsibility for providing shoring, bracing, sloping, or other provisions which are adequate for worker protection.
5. Nothing in this section is intended to relieve the Contractor of his responsibility to carefully examine the contract documents and the site where the Work is to be performed; to familiarize himself with all the local conditions and federal, state, and, local laws, ordinances, rules, and regulations that may affect the performance of any Work; to study all surveys and investigation reports about subsurface and latent physical conditions pertaining to the site; to perform any additional surveys, pot-holing and investigations as the Contractor deems necessary to complete the Work at his bid price; and to correlate the results of all such data with the requirements of the contract documents.

1.06 ALTERNATIVES

- A. The use or application of alternative methods and materials, and the employment of proprietary systems under lease or franchise in lieu of that specified herein, may be allowed. Demonstration of suitability and compliance with these Specifications to the satisfaction of FORA will be required.

1.07 SAFETY

- A. Except as otherwise indicated, the following codes apply to the Work of this Section:
 1. Title 8, California Administrative Code, Chapter 4, Subchapter 4, Construction Safety Orders, Article 6, Excavations, Trenches, Earthwork, Section 1542, Shafts.

PART 2 - MATERIALS

2.01 PRODUCTS

- A. Use new or used materials complying with provisions of an approved shoring, bracing and sheeting design drawings. Materials shall meet the appropriate specification and be free from defects and damage that might in any way impair their protective function.

PART 3 – EXECUTION

3.01 GENERAL

- A. The support system shall extend the main excavation bottom elevation to a depth adequate to prevent lateral movement and to adequately support applied vertical loads. In areas where additional excavation is required below the main excavation subgrade provisions shall be made to prevent movement of main excavation supports. Damage to existing utilities during installation of excavation support system shall be avoided. In flow of ground water shall be prevented and the base of the excavation subgrade shall be maintained in a stable, intact state.

3.02 REMOVAL OF SUPPORT SYSTEMS

- A. Where removal is required wholly or in part, such removal shall be performed in a manner that will not disturb or damage adjacent new or occupied buildings or utilities. Fill all voids immediately by engineer approved means.
- B. All elements of support systems shall be removed to a minimum depth of 6-feet below final ground surface.
- C. All damage to property resulting from removal shall be promptly repaired at no cost to FORA. The Contractor's Engineer, in coordination with FORA, shall be the judge as to the extent and determination of the materials and methods for repair.

END OF SECTION 31 40 00 – SHEETING, SHORING, AND BRACING